

UNIVERSITY OF VAASA

FACULTY OF TECHNOLOGY

TELECOMMUNICATION ENGINEERING

Sheikh Mohsin Habib

**HIGH DATA RATE WIRELESS COMMUNICATION USING MIMO**

Master's thesis for the degree of Master of Science in Technology submitted for inspection, Vaasa, 22 May, 2010.

Supervisor

Professor Mohammed Elmusrati

Instructor

Reino Virrankoski

## ACKNOWLEDGMENTS

I am extremely thankful to my supervisor, Professor Mohammad Elmusrati, whose encouragement, guidance, support and time to time counsel from initial to final level enabled me to complete this theses.

I am also grateful to my instructor, Reino Virrankoski, for his wireless networks and Matlab courses. I had not any prior knowledge of Matlab. He as well as essentially teaching me everything I know about Matlab.

My parents, brother and sisters deserve special mention for their indivisible support and prayers.

Words fail me to express my feelings to my wife Tasmin, little boy Marzouq and little girl Tazmeen who have sacrificed their valuable time and always encourage me from thousands mile away to complete my master's study in time.

Finally, I like to thank all people who have directly or indirectly helped and inspired me during my master's study.

Sheikh Mohsin Habib  
Vaasa, 22 May, 2010

	Page
TABLE OF CONTENTS	2
ACKNOWLEDGMENTS	1
ABBREVIATIONS	4
SYMBOLS	6
ABSTRACT	7
1. INTRODUCTION	8
2. COMMUNICATION OVER MULTIPLE ANTENNAS	10
2.1. Introduction	10
2.2. Beam forming	12
2.3. Diversity	13
2.4. Orthogonal Frequency Division Multiplexing (OFDM)	16
3. SPACE TIME CODING	18
3.1. Introduction	18
3.2. Space Time Block Code	20
3.2.1. Alamouti Code	21
3.2.2. Orthogonal Space Time Block Code (OSTBC)	24
3.2.3. Quasi- Orthogonal Space Time Block Code (Q-OSTBC)	26
3.3. Space Time Trellis Code	26
3.4. Linear Dispersion Code	28
3.5. Spatial Multiplexing	30
4. MIMO WIRELESS COMMUNICATION SYSTEMS	32
4.1. MIMO Channel Models	32
4.1.1. Ray Tracing Deterministic Model	33
4.1.2. One Ring Model	33

4.1.3. Two Ring Model	34
4.1.4. Correlation Based Model	35
4.2. MIMO system Capacity	36
4.2.1. Deterministic Channel	37
4.2.2. Random Channel	45
4.3. Capacity Limits of MIMO channel	48
4.4. Singular Value Decomposition	52
5. SIMULATIONS AND RESULTS	55
6. CONCLUSION	57
REFERENCES	59

## ABBREVIATIONS

3G	3rd Generation
A/D	Analogue to Digital
ADSL	Asymmetric Digital Subscriber Line
Bw	Band Width
CSI	Channel State Information
D/A	Digital to Analogue
dB	Decibel
DOA	Direction of arrival
FEQ	Frequency
FFT	First Fourier Transform
I.I.D	Independent Identical Distribution
IEEE	Institute of Electrical and Electronics Engineers, Inc.
IFFT	Inverse First Fourier Transform
ISI	Inter Symbols Interference
LANs	Local Area Networks
LDC	Linear Dispersion code
LOS	Line of sight
LTE	Long Term Evolution
MIMO	Multiple Input Multiple Output
MISO	Multiple In Single Out
OFDM	Orthogonal Frequency Division Multiplexing
OSTBC	Orthogonal Space Time Block Code
P/S	Parallel to serial
QAM	Quadrature Amplitude Modulation
QOSTBC	Quasi-Orthogonal Space Time Block Code
QPSK	Quadrature Phase shift Keying
SM	Spatial Multiplexing
S/P	Serial to Parallel
SIMO	Single In Multiple Out

SNR	Signal to Noise ratio
STBC	Space Time Block Code
STC	Space Time Code
STTC	Space Time Trellis code
STTC	Space Time Trellis Code
SVD	Singular Value Decomposition
TCM	Trellis Coded modulation
ZMCSCG	Zero Mean Circularly Symmetrical Complex Gaussian

## SYMBOLS

$\Im$	Imaginary part
$\Re$	Real part
$\tau$	Delay spread
$*$	Convolution operator
$\otimes$	kronecker product operator
$I_0(x)$	Modified Bessel function of 0 <sup>th</sup> order
$J_0(x)$	Bessel function of 0 <sup>th</sup> order
$I(X;Y)$	Mutual information between X and Y
$H(X)$	Entropy of random variable X
$H(Y X)$	Conditional entropy of random variable Y given random variable X
$I_N$	N×N identity matrix
$\det$	Determinant
$\epsilon$	Expectation operator
$X^H$	Hermitian (complex conjugate) transpose
$X^T$	Transpose of matrix x

---

**UNIVERSITY OF VAASA****Faculty of Technology**

<b>Author:</b>	Sheikh Mohsin Habib
<b>Topic of the Thesis:</b>	High Data Rate Wireless Communication using MIMO
<b>Supervisor:</b>	Prof. Mohammed Elmusrati
<b>Instructor:</b>	Reino Virrankoski
<b>Degree:</b>	Master of Science in Technology
<b>Department:</b>	Department of Computer Science
<b>Degree of Program:</b>	Master's Program in Telecommunication Engineering
<b>Major Subject:</b>	Telecommunication Engineering
<b>Year of Entering the University:</b>	2007
<b>Year of Completing the Thesis:</b>	2010
	<b>Pages: 62</b>

---

**ABSTRACT:**

Wireless communication is the most popular and rapidly growing sector of the communication industry. The permitted bandwidth for every service is very limited and the demand of data transferring is increasing day by day. Moreover, the channels are further limited by multipath and fading. Hence, it is a big challenge to provide excellent quality of service and meet the growing demand with the existing bandwidth limitation. MIMO is one very promising technique to enhance the data rate.

Fading has been considered as problem for high quality with low outage wireless communication. However, multiple-input multiple-output (MIMO) antenna has used this fading phenomenon not only to mitigate the fading but also to exploit this fading to obtain high data rate through spatial multiplexing.

In this thesis, MIMO spatial multiplexing has been studied in details. Different MIMO channel models, space time coding, and channel capacity constraints as well as the factors those limits the capacity are studied. One major aim of this study is to find a combined optimal solution for MIMO system so that it could provide high rate data transfer.

---

**KEYWORDS:** MIMO, Space-Time coding, Channel Capacity, Spatial Multiplexing, Capacity Limitation



## 1. INTRODUCTION

Communication is the route of handing over information, and for thousands of years concerned either close proximity for voice or the time delay associated with transportation of a letter or other physical medium. With the nineteenth century discovery of the telegraph and telephone, information could be moved by electronic means through a wire in real time, eliminating the transportation delay. The Radio is capable of wireless communication using electromagnetic radiation, and has been available for practical use for nearly one hundred years. Wireless communication is the most popular and rapidly growing sector of the communication industry. It relaxes the constraint of a physical connection and supports moving communication with one or many receivers and can provide high-speed high-quality information exchange between or among fixed, mobile and/or portable devices located anywhere in the world. Unfortunately, the allowable bandwidth for every service is extremely inadequate and the demand of data transferring is increasing day by day. Moreover, the channels are further limited by multipath and fading. Thus, it is a big challenge to provide excellent quality of service and meet the growing demand with the existing limited data rate.

To achieve a high spectral efficiency, a number of advanced techniques and algorithms are exploited. One of the unique solutions is to use MIMO technology to provide a high data rate. The MIMO wireless system uses multiple antennas at both the transmitter and the receiver to enhance capacity gain. The capacity of the MIMO system increases almost linearly with the number of antenna in receiver and transmitter terminal. Through the use of sophisticated signal coding technique and modulation scheme, MIMO can provide and increase data rate compared to the conventional single antenna cellular systems. In this research paper, to realize the potential of MIMO wireless system, I have focused on some important issues such as multiple antenna technique, space time block coding (STBC), channel models, capacity formulations and singular value decomposition.

In chapter 1, the wireless communication background, objective and motivation of this thesis will be presented. Chapter 2 will review multiple antenna technique, OFDM, diversity and beam forming. Signaling techniques are very important for improving the robustness of the communication link and the channel capacity. So, different space time coding is studied in chapter 3. In chapter 4, MIMO channel characterization, modeling, capacity constraints, capacity limitation and singular value decomposition will be discussed in detail. Results and simulations are presented in chapter 5 whereas chapter 6 will present conclusion and possible future trends of MIMO system.

## 2. COMMUNICATION OVER MULTIPLE ANTENNAS

### 2.1. Introduction

Wireless communication is the most prominent and the fast growing sector of the communication industry. But due to multipath fading, the continuous reliable wireless communication suffers a lot of difficult challenges compared to fiber, coaxial cable, line of sight microwave or satellite transmission (Alamouti 1998: 1451).

It is extremely difficult to increase the quality of service or to reduce the effective error rate in multipath faded channel. One of the most conventional effective techniques to mitigate multipath fading is to control transmitter power. But this approach is only theoretical (Alamouti 1998: 1451). It does not have any practical viability because any increase of power in transmitter makes it bulky and increases the cost of amplifier. Moreover, the radiation power has been limited by regulation authority (more radiated power increase interference and noise to other operator).

In other way, time interleaving (with error correction coding) and spread spectrum can provide diversity improvement and hence mitigates fading problem. But in slowly varying channel time interleaving results large delays while spread spectrum techniques are ineffective when the delay spread in channel is relatively small ( Alamouti 1998: 1451).

Antenna diversity i.e. using multiple antennas is a practical, effective and widely used technique to mitigate the effect of multipath fading (Alamouti 1998: 1451). The use of multiple antenna at both the transmit and the receive end i.e. MIMO not only mitigate the fading problem but also provide higher bit rate , reduce error rate and mitigate co-channel interference (Mietzner, Schober, Lampe, Gerstacker, & Hoehner 2009: 87). In Figure 2, it is seen that BER is decreased with the increase in number of antenna. Once fading was a big challenge for wireless communication, now the deployment of MIMO makes it beneficial for wireless communication. The benefits of multiple antennas for wireless communication systems are depicted in Figure 1 (Mietzner et al. 2009: 88).

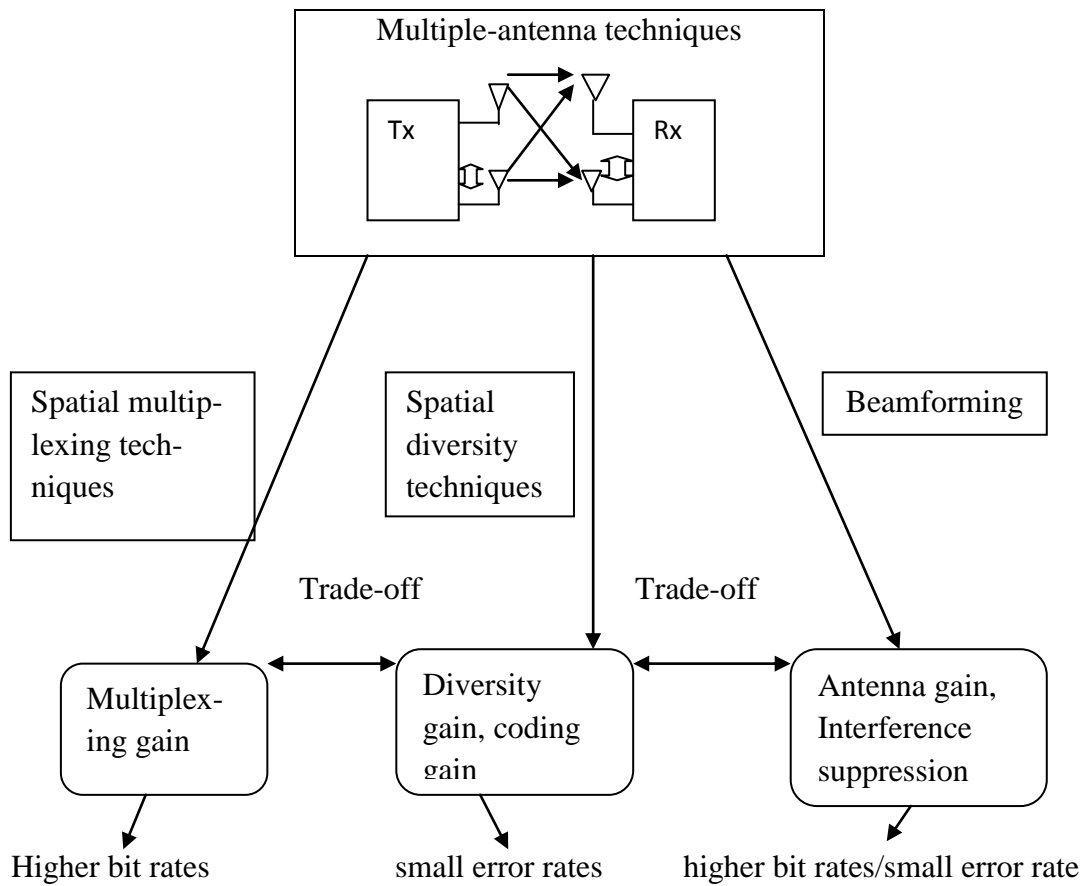

**Figure 1.** Benefits of multiple-antenna techniques for wireless communications (Mietzner et al. 2009: 88)

Besides a lot of benefits, the multiple antennas have some drawbacks as well. It increases hardware cost and power consumption. Real time implementations of near-optimum multiple antenna techniques are difficult (Mietzner et al. 2009: 89).

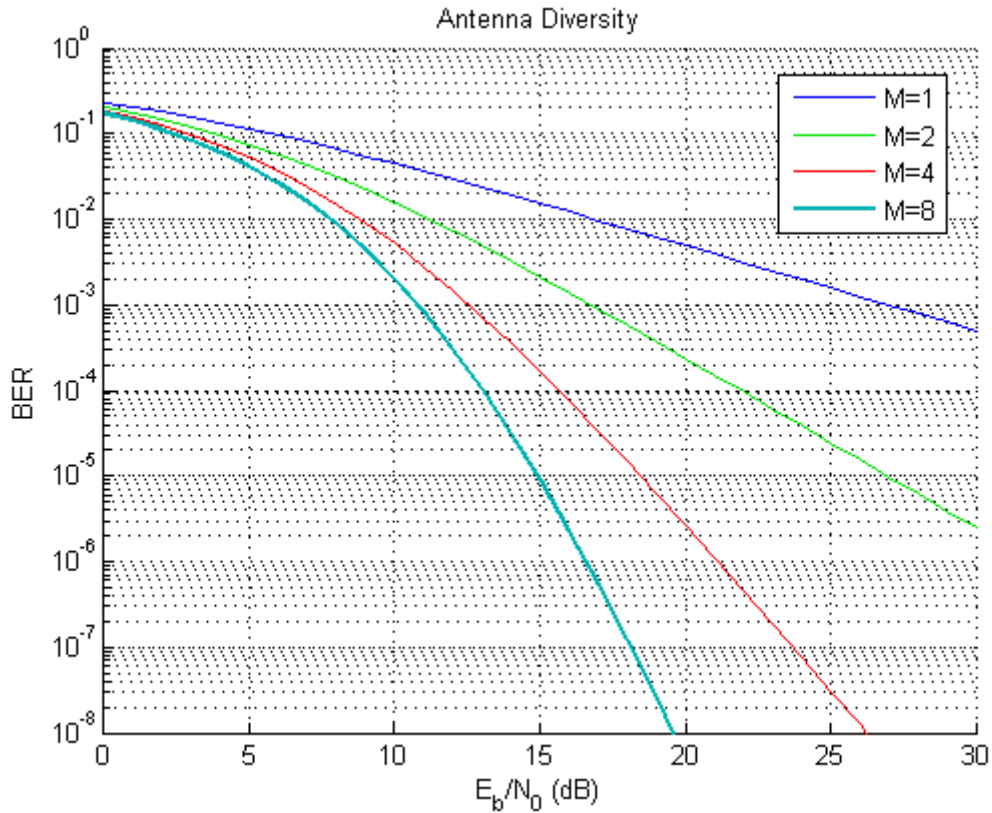

**Figure 2.** Multi-antenna diversity at Rayleigh fading channel.

## 2.2. Beam forming

Beam forming is a powerful technique to maximize signal to noise and interference ratio (SINR) through focusing energy to the subscriber devices. In a conventional system, the radiation pattern covers the whole cell area whereas in MIMO, the transmitter radiates only to the desired user direction. Adding beam forming to a MIMO signal can generate a significant amount of additional gain which can be used for either cell coverage area or for better building wall penetration, or the better signal to noise ratio, results in higher capacity. Beam forming is broadly classified into two categories –direction of arrival (DOA) based beam forming and eigen beam forming (Andrews, Ghosh & Muhammed 2007:169).

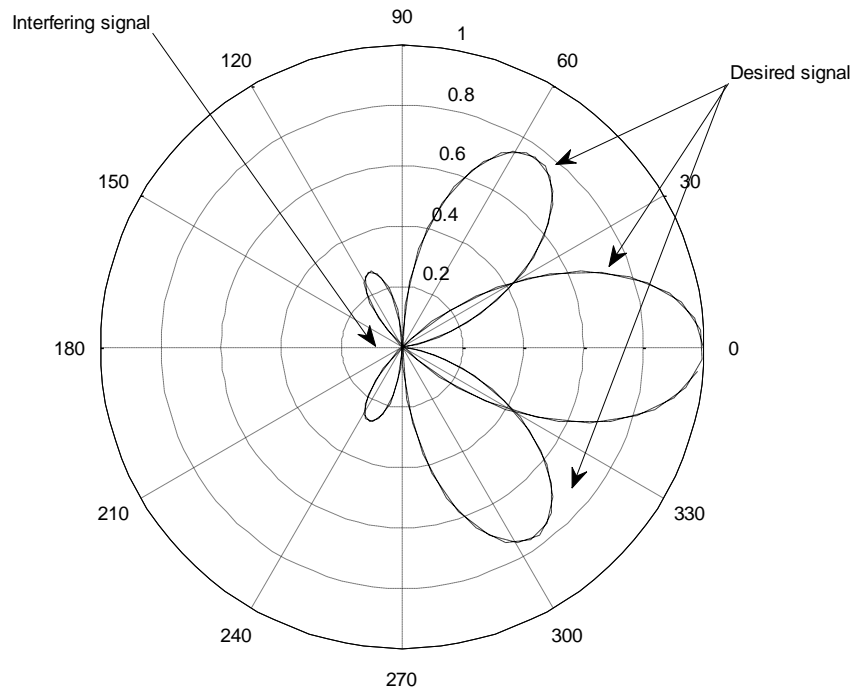

**Figure 3.** DOA beam forming

Figure 3 shows the DOA based beam forming in which the beam former has unity gain for the targeted user while nulls at the direction of interferers. This scheme is only successful when the number of antenna element is larger than the number of interferers and is viable only in line of sight environment or limited local scattered environment (Andrews et al. 2007: 172).

The eigen beam former is optimum beam former and can be used for transmitting multiple data streams if the perfect channel state information at both the transmitter and the receiver are available (Andrews et al. 2007: 173).

### 2.3. Diversity

In diversity technique a multiple version of the same signal is transmitted over the channel through multipath. So the probability of the signal to be faded is reduced subject to all the signal versions affected by independent fading conditions. There are different types of diversity such as time, frequency, space, pattern, polarization. Appropriate coding and interleaving is used to provide time diversity while frequency diversity is obtained by temporal spreading of the channel through multicarrier modulation (Heath 2009). The last three diversities are due to the use of multiple antennas which are depicted in Figure 4, 5 & 6.

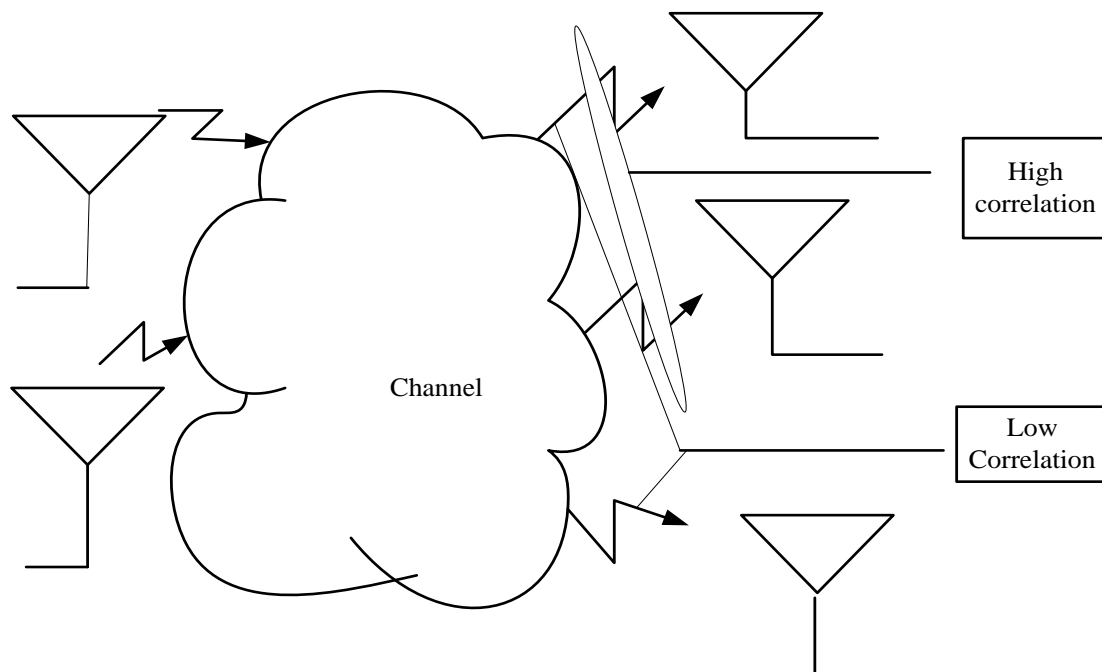

**Figure 4.** Space diversity in MIMO

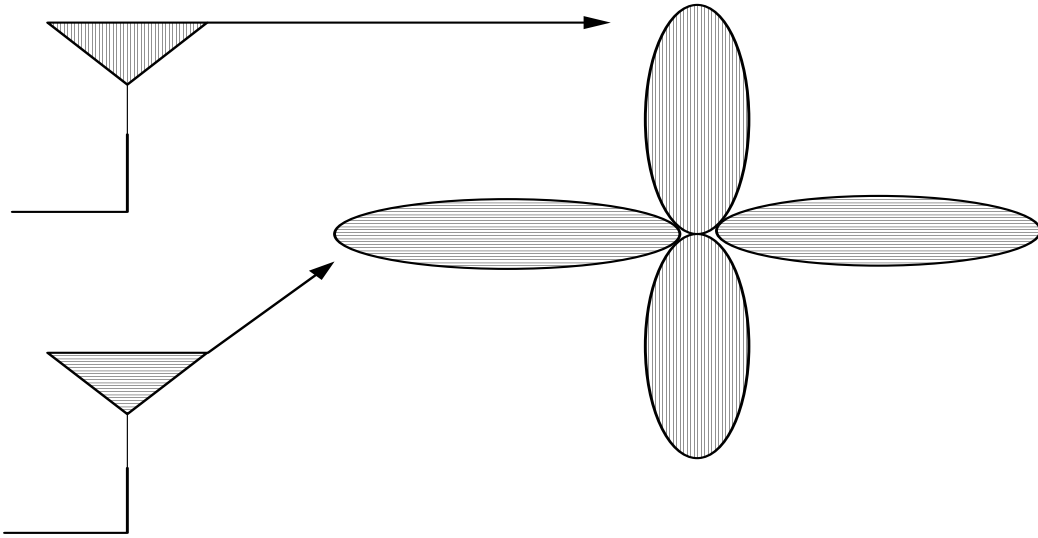

**Figure 5.** Pattern diversity in MIMO

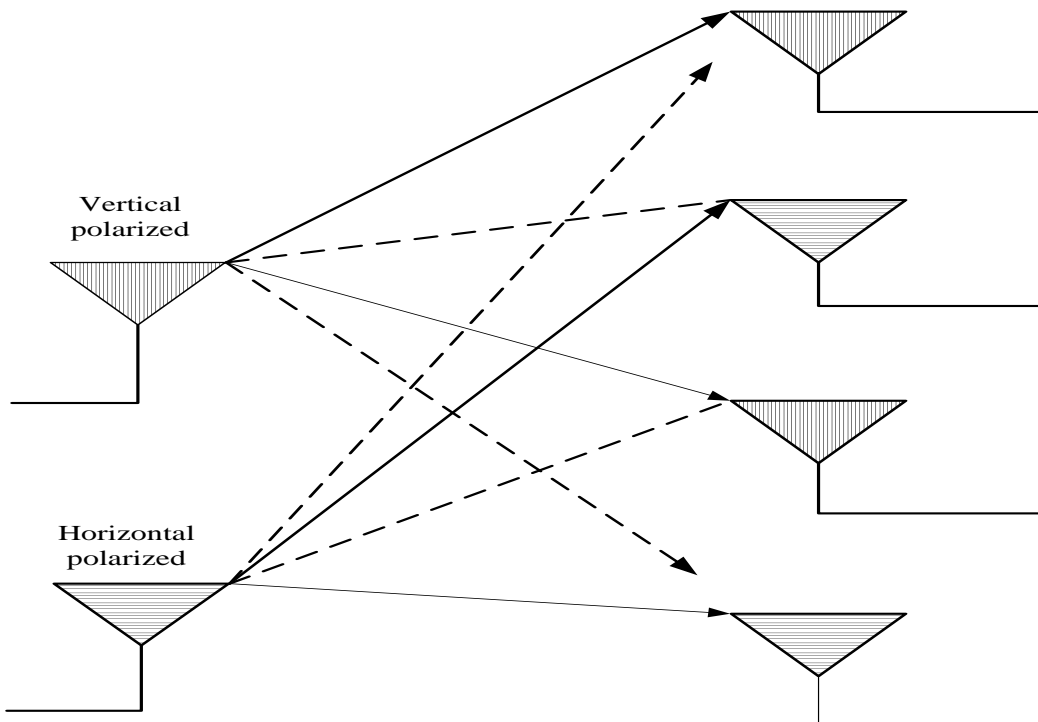

**Figure 6.** Polarization diversity in MIMO



#### 2.4. OFDM (Orthogonal Frequency Division Multiplexing)

OFDM is a popular multicarrier modulation technique that is used in digital subscriber lines, wireless LANs(802.11a/g/n), digital video broadcasting standard, ADSL standard, Wimax, 3G LTE and fourth generation cellular systems. OFDM modulation divides a broadband channel (high rate transmit bit stream) into many parallel sub-channels (lower rate sub streams). If  $T_s$ ,  $L$  and  $\tau$  denote symbol time, number of sub channel and delay spread respectively than  $\frac{T_s}{L}$  should be  $\gg \tau$  (Andrews et al. 2007: 115).

The data rate of each sub channel is kept much lower than the total data rate, which results in the fact that the sub channel band width is lower than the total band width. The number of sub channel is chosen to ensure that the sub channel bandwidth is less than the coherence band width of the channel. Thus each sub channel experience relatively flat fading and the result is almost ISI free communication. (UCLA 2009.)

Typically, the sub channels are orthogonal and each sub channels is an integer multiple of a fundamental frequency. This ensures interference free transmission even if the sub channels overlap each other. That is why FFT and IFFT are used in modulation and demodulation scheme respectively. To prevent interference between subsequent OFDM symbols, a guard band is introduced. To mitigate ISI problem, a cyclic prefix is added to the original signal to perform circular convolution. (UCLA 2009.)

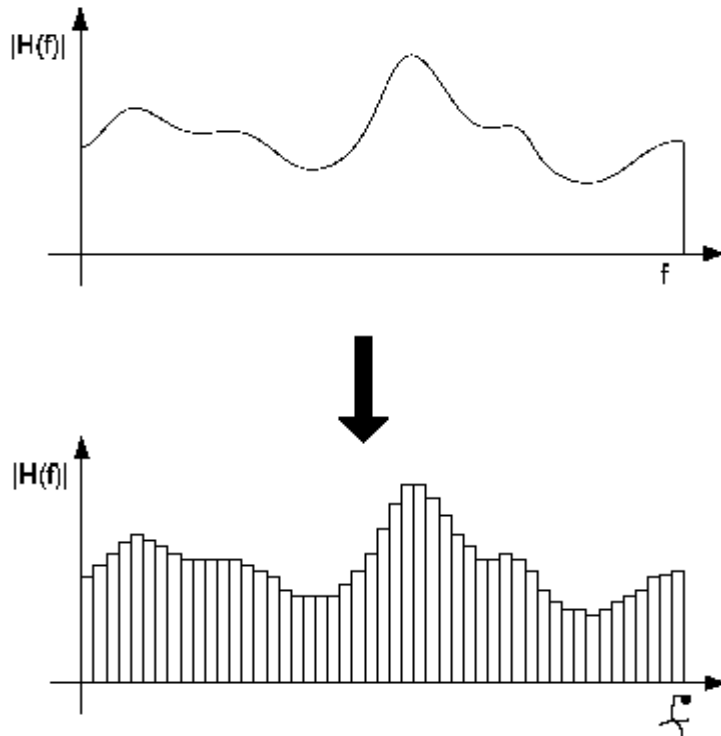

**Figure 7.** A broadband channel divided into many parallel narrowband channels (UCLA 2009)

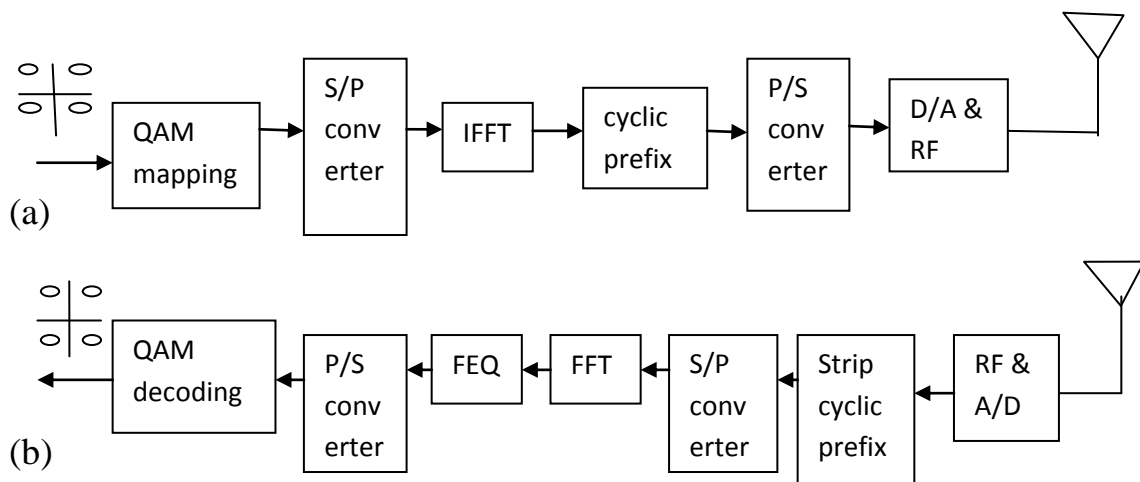

**Figure 8.** (a) Modulator and (b) Demodulator

The basic block diagram of a typical OFDM modulator and demodulator is depicted in Figure 8.

### 3. SPACE TIME CODING AND DECODING

#### 3.1 Introduction

Space time coding is a signaling technique to improve the robustness of the communication link especially in MIMO wireless communication. These codes are used with multiple transmitters to provide transmit diversity in a systematic and optimal way in both spatial and temporal domain (Alvarez, Torres-Román, Kontorovitch 2005:467).

There are two basic approach to STC; coherent and non-coherent. In non-coherent STC neither the transmitter nor the receiver has the channel state information (CSI). In coherent type, only the receiver has the CSI. Space time coding can be broadly classified into two groups - space time block code (STBC) and space time trellis code (STTC). Both groups have a large number of different coding schemes. Every code has its merits and demerits. Spatial multiplexing supports high data rate but fails to control transmit diversity. OSTBCs provide the full diversity but suffer from a limited spatial multiplexing rate. Linear dispersion codes provide high data rate as well as maintain full transmit diversity. The algebraic and LDCs make the receiver very complex. STTC provide full diversity and coding gain but its decoding technique is very complex. (Oestges & Clercks 2007: 155-222.)

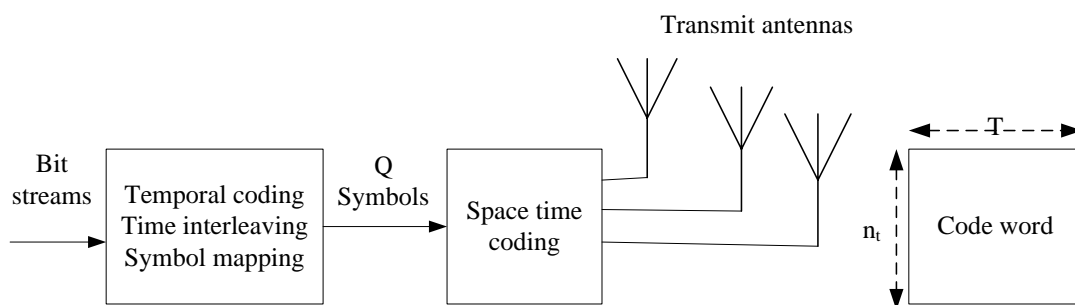
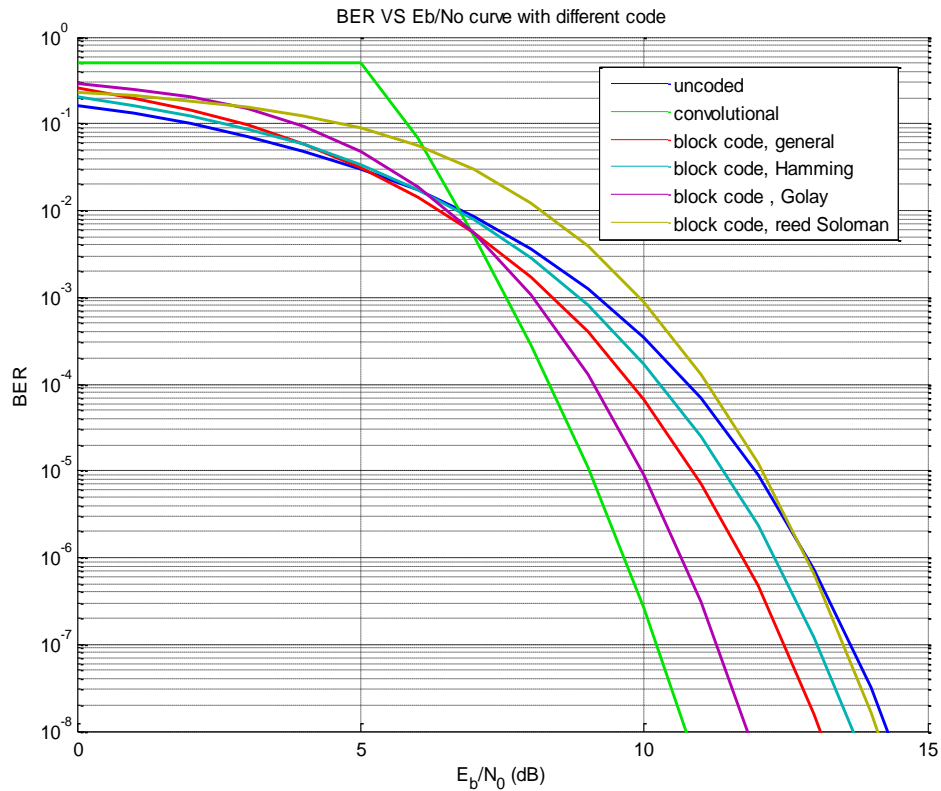

**Figure 9.** General overview of space-time encoder of MIMO system (Oestges & Clercks 2007: 156).

A general overview of space time encoder is shown in Figure 9. Suppose,  $N_{Tx}$  and  $N_{Rx}$  be the number of transmit and receive antenna respectively.  $Q$  is the number of symbols. The sequence of symbols is then spread in space and in time through the  $N_{Tx}$  transmit antenna and over  $T$  symbol period respectively and a corresponding codeword represented by a matrix  $C$  is  $N_{Tx} \times T$ . (Varshney, Arumugam, Vijayaraghavan, Vijay & Srikanth 2003: 36.)

$$C = \begin{bmatrix} C_1^1 & C_2^1 & \dots & \dots & C_{N_{Tx}}^1 \\ \dots & \dots & \dots & \dots & \dots \\ \dots & \dots & \dots & \dots & \dots \\ \dots & \dots & \dots & \dots & \dots \\ C_1^T & \dots & \dots & \dots & C_{N_{Tx}}^T \end{bmatrix} \quad (3.1)$$

In this thesis, some important categories of space time code have been discussed.



**Figure 10.** BER for different codes.

### 3.2 Space Time Block Code (STBC)

In STBC, the code matrix is formed by buffering a block of data symbol. This data symbols are transmitted through multiple antenna and detected again at receiver using suitable techniques. The main challenges of forming code matrix in STBC are to maximize diversity gain, coding gain and channel capacity (Varshney et al.:37). The main advantage of this coding is the low decoding complexity (Oestges & Clercks 2007: 170).

The linear type of STBC is widely used because it spreads information symbols in space and time and thus improves diversity gain and multiplexing rate. Usually data rate is increased in this scheme by increasing symbol number in a given code word. A linear STBC is expressed as (Oestges & Clercks 2007: 171):

$$C = \sum_{q=1}^Q \Phi_q \Re[C_q] + \Phi_{q+Q} \Im[C_q] \quad (3.2)$$

Where,  $\Phi_q$  = complex basis matrices ,  $C_q$  = complex information symbol

$Q$  = number of complex symbols  $C_q$  transmitted over a code word

$\Re$  = real part and  $\Im$  = imaginary part

Consider the MIMO frequency flat fading channel with  $n_t$  transmit and  $n_r$  receive antenna, the code word  $C = [c_0, c_1, \dots, c_{T-1}]$  is of size  $n_t \times T$ . This signal is transmitted over  $T$  symbols via  $n_t$  transmit antennas. At the  $k^{\text{th}}$  time instant the transmitted and received signals are related by (Oestges & Clercks 2007: 156):

$$Y_k = \sqrt{E_s} H_k C_k + n_k \quad (3.3)$$

Where,  $Y_k = n_r \times 1$  received signal vector,  $n_k = \text{AGWN}$

$E_s$  = energy normalized factor,  $C_k$  = Code word

$H_k = n_t \times n_r$  channel matrix

Applying vector operator to Equation (3.2) and using Equation (3.2), we can write (Oestges & Clercks 2007: 171):

$$Y = HXS + N \quad (3.4)$$

Where,

$$Y, \text{ is the channel output vector} = \begin{bmatrix} R[y_0, \dots, y_{n-1}] \\ I[y_0, \dots, y_{n-1}] \end{bmatrix}$$

$$H, \text{ is the block diagonal channel} = I_T \otimes H', \quad H' = \begin{bmatrix} R[\tilde{H}] & -I[\tilde{H}] \\ I[\tilde{H}] & R[\tilde{H}] \end{bmatrix}$$

$$X, \text{ is the linear code matrix} = \left[ \text{vec} \begin{bmatrix} R[\Phi_1] \\ I[\Phi_1] \end{bmatrix}, \dots, \text{vec} \begin{bmatrix} R[\Phi_{2\varrho}] \\ I[\Phi_{2\varrho}] \end{bmatrix} \right]$$

$$S, \text{ a block of un coded symbol (input)} = [R[C_1] \dots R[C_\varrho] \dots I[C_1] \dots I[C_\varrho]]^T$$

$$N \text{ is the noise vector} = \text{Vec} \left( \begin{bmatrix} R[n_0, \dots, n_{T-1}] \\ I[n_0, \dots, n_{T-1}] \end{bmatrix} \right)$$

The multiplexing rate in STBC is defined as,  $r_s = Q/R$  (Oestges & Clercks 2007: 171).

At,  $r_s = n_t$ , the STBC offers full rate code.

The Ergodic MIMO channel capacity in optimal linear STBC is given by (Oestges & Clercks 2007: 175):

$$\tilde{C} = \max_{\text{Tr}[XX^T] \leq 2T} \frac{1}{2T} \epsilon_H \{ \log_2 \det(I_{2n_r T} + \frac{\rho}{2} HXX^T H^T) \} \quad (3.5)$$

Out of different sub class of STBC, some most useful codes are described in the following sub section.

### 3.2.1 Alamouti code

The Alamouti code is the first STBC that has suitably designed for two transmit antennas and is able to provide full diversity at full data rate. In this coding technique, using 2 transmit antenna and M receive antenna, a diversity order of 2M can be obtained. Moreover, this method does not require any feedback from the receiver to transmitter or bandwidth expansion. It has very small computation complexity and can improve error performance, data rate and capacity and range of wireless communication system. (Alamouti 1998:1451.)

Let  $S_1$  and  $S_2$  are the signal to be transmitted from transmitting antenna  $T_{x1}$  and  $T_{x2}$  respectively. At the first symbol period, the signal is  $(S_1, S_2)$  and during the next symbol period the signal transmitting from antenna  $T_{x1}$  and  $T_{x2}$  are  $-S_1^*$  and  $S_2^*$  respectively, which has shown in Table 1 (Alamouti 1998:1451).

**Table1.** Encoding and transmission sequence

	$T_{x1}$	$T_{x2}$
First time slot	$S_1$	$S_2$
Second time slot	$-S_1^*$	$S_2^*$

**Table 2.** Channel matrix sequence between Tx and Rx

	$R_{x1}$	$R_{x2}$
$T_{x1}$	$h_0$	$h_2$
$T_{x2}$	$h_1$	$h_3$

**Table 3.** Received signal notation at two receivers

	$R_{x1}$	$R_{x2}$
First time slot	$r_0$	$r_2$
Second time slot	$r_1$	$r_3$

Assume the fading is constant across the two consecutive symbols. We can write the channel matrix as:

$$H = \begin{bmatrix} h_0 & h_2 \\ h_1 & h_3 \end{bmatrix} \quad (3.6)$$

The received signals at receiver antennas are given by (Alamouti 1998:1451):

$$r_0 = h_0 S_1 + h_1 S_2 + n_0 \quad (3.7)$$

$$r_1 = -h_0 S_2^* + h_1 S_1^* + n_1 \quad (3.8)$$

$$r_2 = h_2 S_1 + h_3 S_2 + n_2 \quad (3.9)$$

$$r_3 = -h_2 S_2^* + h_3 S_1^* + n_3 \quad (3.10)$$

Where,  $n_i$  ( $i=0, 1, \dots, 3$ ) is complex Gaussian variable (noise term).

Using maximum likelihood receiver, the output can be expressed as

$$y_0 = h_0^* r_0 + h_1^* r_1 + h_2^* r_2 + h_3^* r_3 \quad (3.11)$$

$$y_1 = h_1^* r_0 - h_0^* r_1 + h_3^* r_2 - h_2^* r_3 \quad (3.12)$$

From the above set of equations, we can write

$$y_0 = (\alpha_0^2 + \alpha_1^2 + \alpha_2^2 + \alpha_3^2) S_1 + h_0^* n_0 + h_1^* n_1 + h_2^* n_2 + h_3^* n_3 \quad (3.13)$$

$$y_1 = (\alpha_0^2 + \alpha_1^2 + \alpha_2^2 + \alpha_3^2) S_2 - h_0^* n_1 + h_1^* n_0 - h_2^* n_3 + h_3^* n_2 \quad (3.14)$$

These combined signals are then sent to the maximum likelihood decoder and the equivalent output SNR becomes

$$\text{SNR} = (\alpha_0^2 + \alpha_1^2 + \alpha_2^2 + \alpha_3^2) \cdot (P_t/2N_0) \quad (3.15)$$

It clearly indicates a diversity order of 4 which is equivalent to 4 branch MRRC scheme (Alamouti 1998:1454). The main advantage of this scheme is that even if one of the chains fails, the signal may still be detected (but with less quality).



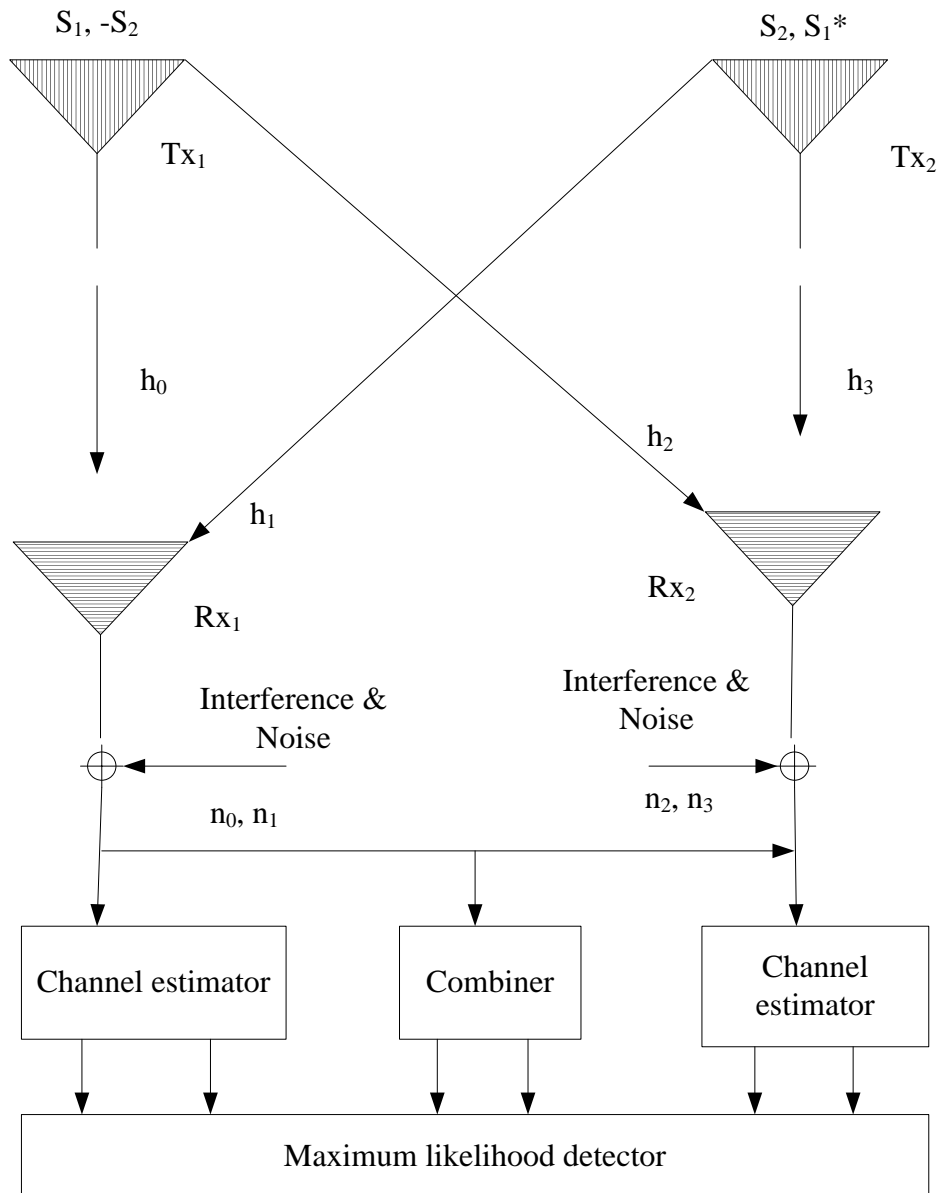

**Figure 11.** Two branches transmit diversity with two receivers (Alamouti 1998:1454).

### 3.2.2 Orthogonal Space Time Block Code (OSTBC)

OSTBC is an important sub-class of linear STBC. It is extremely easy to decode.

From STBC, we know (Oestges & Clercks 2007: 171):

$$C = \sum_{q=1}^Q \Phi_q \Re[C_q] + \Phi_{q+Q} \Im[C_q] \quad (3.16)$$

The main properties of OSTBC are (Oestges & Clercks 2007: 192):

- i. The basis matrix are wide unitary i.e.

$$\Phi_q \Phi_q^H = \frac{T}{\Phi_{n_t}} I_{n_t} \quad (3.17)$$

- ii. The basis matrix are skew-Hermitian i.e.

$$\Phi_q \Phi_p^H + \Phi_p \Phi_q^H = 0 \quad (3.18)$$

Combinely, we can write (Oestges & Clercks 2007: 192):

$$CC^H = \frac{T}{\Phi_{n_t}} \sum_{q=1}^Q |C_q|^2 I_{n_t} \quad (3.19)$$

The codeword for three transmit antenna and four symbols duration with a multiplexing rate 1 can be given as (Oestges & Clercks 2007: 193):

$$C = \frac{1}{\sqrt{3}} \begin{bmatrix} C_1 & -C_2 & -C_3 & -C_4 \\ C_2 & C_1 & C_4 & -C_3 \\ C_3 & -C_4 & C_1 & C_2 \end{bmatrix} \quad (3.20)$$

OSTBC minimizes the maximum average-error probability over i.i.d slow Rayleigh fading channels and is given by (Oestges & Clercks 2007: 195):

$$P(C \rightarrow E) = \frac{1}{\pi} \int_0^{\frac{\pi}{2}} \left(1 + n \frac{T}{Q_{n_t}} \sum_{q=1}^Q |C_q - C_q'|^2\right)^{-n_t} dB \quad (3.21)$$

$$= \frac{1}{2} \left[ 1 - \sqrt{\frac{\rho_s}{1 + \rho_s}} \sum_{i=0}^{n_t-1} \binom{2i}{i} \left(\frac{1}{4(1 + \rho_s)}\right)^i \right] \quad (3.22)$$

$$\text{Where, } \rho_s = \frac{\rho}{4} \frac{T}{Q_{n_t}} \sum_{q=1}^Q (|C_q - C_q|^2) \quad (3.23)$$

The pair wise error probability directly affects the bit error rate thus increases the channel capacity (Varshney et al.:37).

### 3.2.3 Quasi- Orthogonal Space Time Block Code (Q-OSTBC)

Quasi-OSTBC can provide full diversity and higher spatial multiplexing rate. It is made of  $2Q$  complex symbols. If  $O(C_1, \dots, C_Q)$  be an O-STBC code then Q-OSTBC code is  $Q(C_1, \dots, C_{2Q})$  and is expressed as (Oestges & Clercks 2007: 199-200):

$$Q(C_1, \dots, C_{2Q}) = \begin{bmatrix} O(C_1, \dots, C_Q) & O(C_{(Q+1)}, \dots, C_{2Q}) \\ O(C_{(Q+1)}, \dots, C_{2Q}) & O(C_1, \dots, C_Q) \end{bmatrix} \quad (3.24)$$

Alternately, we can write,

$$Q(C_1, \dots, C_{2Q}) = \begin{bmatrix} O(C_1, \dots, C_Q) & -O(C_{(Q+1)}, \dots, C_{2Q})^* \\ O(C_{(Q+1)}, \dots, C_{2Q}) & O(C_1, \dots, C_Q)^* \end{bmatrix} \quad (3.25)$$

For  $n_t = 4$ , Q-OSTBC can be written as (From Alamouti code):

$$C = \frac{1}{2} \begin{bmatrix} C_1 & C_2^* & C_3^* & C_4 \\ C_2 & C_1^* & C_4^* & C_3 \\ C_3 & C_4^* & C_1^* & C_2 \\ C_4 & C_3^* & C_2^* & C_1 \end{bmatrix} \quad (3.26)$$

### 3.3 Space Time Trellis Code

STTC is similar to trellis coded modulation (TCM) in single in single out (SISO) system. The coding gain of STTC is measured from the structure of the trellis and the

number of states in it (Varshney et al.:38). Usually a soft viterbi decoder is used at receiver to retrieve the signal. At each time instant a block of data symbol is fed to the input of the STT encoder. The output symbols are transmitted from multiple antennas (Varshney et al.:37). To bring the encoder in zero state, a tail of zero is triggered in the decoder.

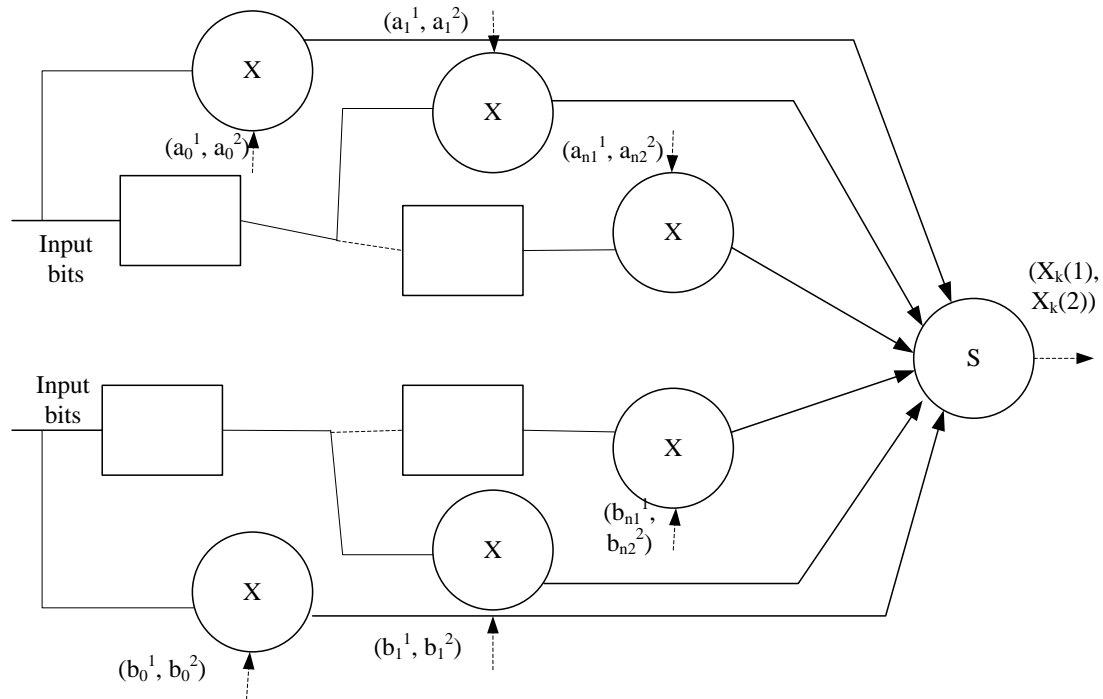

**Figure 12.** STTC encoder for two transmit antennas (Oestges & Clercks 2007: 213).

In Figure 12, two transmit antenna STT encoder has been shown. If the memory orders  $v_1=1$  and  $v_2=2$ , the code generator matrix  $G$  is given by (Oestges & Clercks 2007:212):

$$G^T = \begin{bmatrix} a_0^1 & b_0^1 & a_1^1 & b_1^1 & b_2^1 \\ a_0^2 & b_0^2 & a_1^2 & a_1^2 & b_2^2 \end{bmatrix} \quad (3.27)$$

The same symbol is transmitted through both antennas but at different time instant and thus provides diversity gain. STTC not only provides the same diversity gain as the STBC does, but also provides coding gain (for the same number of transmit and receive antenna). Offcourse, this gain increases the receiver complexity as more as the number

of trellis state and number of transmit antenna increases. (Oestges & Clercks 2007: 211).

In Figure 13, an example of STT code has been shown. An alphabet consists of the integer-modulo 4 is used for convolution encoding of each transmitter. The resulting output symbols are mapped to a QPSK alphabet. The co-efficient  $n_p$ ,  $m_q$  determines the code (Bliss, Forsythe & Chan 2005:112).

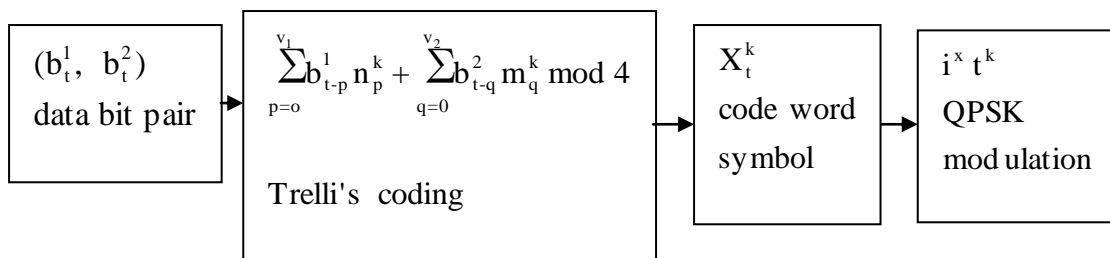

**Figure 13.** Example of space time trellis code (Bliss, Forsythe & Chan 2005:112).

### 3.4 Linear Dispersion code

These types of codes improve the skew-Hermitian conditions and increase the data rates as well as transmit diversity. Let consider a propagation channel is constant and known to the receiver. There are  $N_T$  transmit antenna and  $N_R$  receive antenna and  $T$  be the symbol period. The transmitted signal matrix  $S = N_T \times N_R$ . Now, assume that the data sequence is broken into  $Q$  sub streams i.e.

$$Q = [S_1, S_2, \dots, S_Q] \quad (3.28)$$

Where, symbols are complex with  $r$ -PSK or  $r$ -QAM constellation. Multiplexing rate (Hassibi & Hochwald 2001: 2461):

$$R = (Q/T) \cdot \log_2 r \quad (3.29)$$

For linear dispersion code, we get (Hassibi & Hochwald 2001: 2461):

$$S = \sum_{q=1}^Q (\alpha_q A_q + j\beta_q B_q) \quad (3.30)$$

$$\text{Where, } S_q = \alpha_q + j\beta_q, \quad q=1,2,\dots,Q \quad (3.31)$$

We further assume that  $A_q$  and  $B_q$  are fixed  $T \times N_T$  matrices and  $\alpha_1, \dots, \alpha_Q$  and  $\beta_1, \dots, \beta_Q$  have variance  $\frac{1}{2}$  and are un-correlated. So, we can re-write the Equation (3.30) as

(Hassibi & Hochwald 2001: 2462):

$$\sum_{q=1}^Q t_r (A_q^* A_q + t_r B_q^* B_q) = 2T.N_T \quad (3.32)$$

Using the basic input-output relation of MIMO system equation i.e.  $Y=HXS+N$ , the received signal in LDC can be written as (Hassibi & Hochwald 2001: 2463):

$$\begin{bmatrix} Y_{R,1} \\ Y_{I,1} \\ \dots \\ Y_{R,N} \\ Y_{I,N} \end{bmatrix} = \sqrt{\frac{\rho}{N_T}} H \begin{bmatrix} \alpha_1 \\ \beta_1 \\ \dots \\ \alpha_Q \\ \beta_Q \end{bmatrix} + \begin{bmatrix} V_{R,1} \\ V_{I,1} \\ \dots \\ V_{R,N} \\ V_{I,N} \end{bmatrix} \quad (3.33)$$

Where,  $H$  is the equivalent channel matrix

$Y_R, V_R$  are real part of received signal and noise.

$Y_I, V_I$  are imaginary part of received signal and noise.

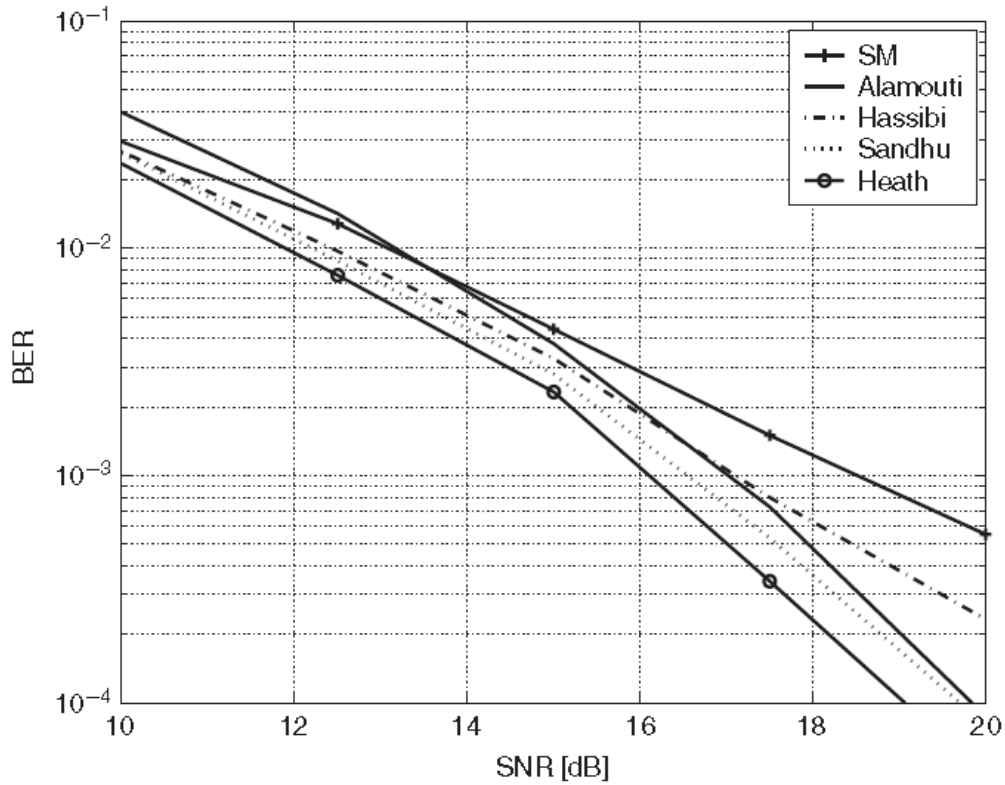
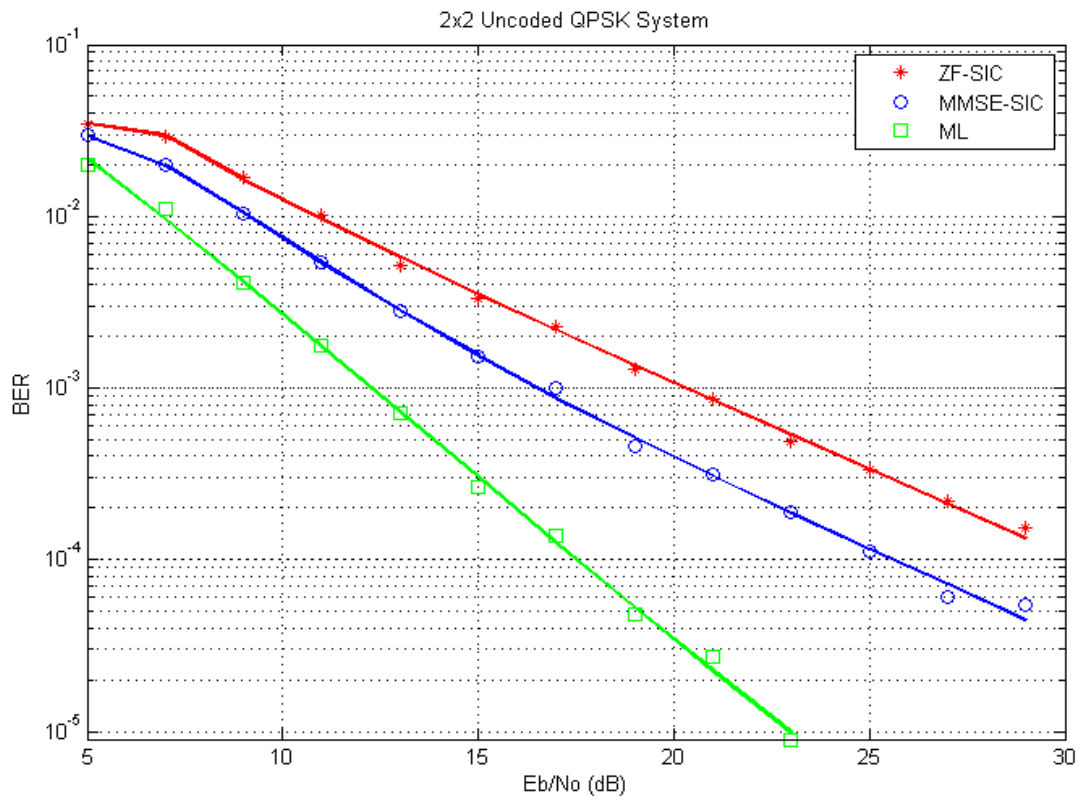

**Figure 14.** Bit error rate (BER) of several LDCs in i.i.d. Rayleigh slow fading channels with  $n_t = 2$  and  $n_r = 2$  for 4 bits/s/Hz (Oestges & Clercks 2007:204).

### 3.5 Spatial Multiplexing

Spatial multiplexing (SM) is an excellent type of MIMO communication in which the incoming high rate data stream is broken into many independent data streams (Andrews et al. 2007: 174). To obtain full diversity order, the uncoded bit streams are transmitted from all the transmit antenna through serial encoder (Goldsmith 2005: 340). SM follows the similar standard mathematical model which is used for space time coding i.e. for a  $N_t$  transmit antenna and  $N_r$  receive antenna system, it follows  $Y = Hx + n$ . The capacity of SM is,

$$C = \min(N_t, N_r) \log_2(1 + \text{SNR}) \quad (3.34)$$



**Figure 15.** BER vs  $E_b/N_0$  plot for three different Spatial Multiplexing systems (courtesy; The MathWorks, Inc.)



## 4. MIMO WIRELESS COMMUNICATION SYSTEMS

### 4.1 MIMO Channel Models

The performance of MIMO systems depend on a number of parameter including the propagation medium, thermal and system related noise, co-channel interference and the structure of antenna array (Verma, Mahajan & Rohila 2008:1; Zein ,Farhat , Pajusco , Conrat, LOSTANLEN ,Vauzelle & Pousset 2009:8). The modeling of the channels is essential for getting maximum benefit of MIMO system. The different models have different construct and analysis complexity as well as advantages and disadvantages.

MIMO channel models can be classified as follows

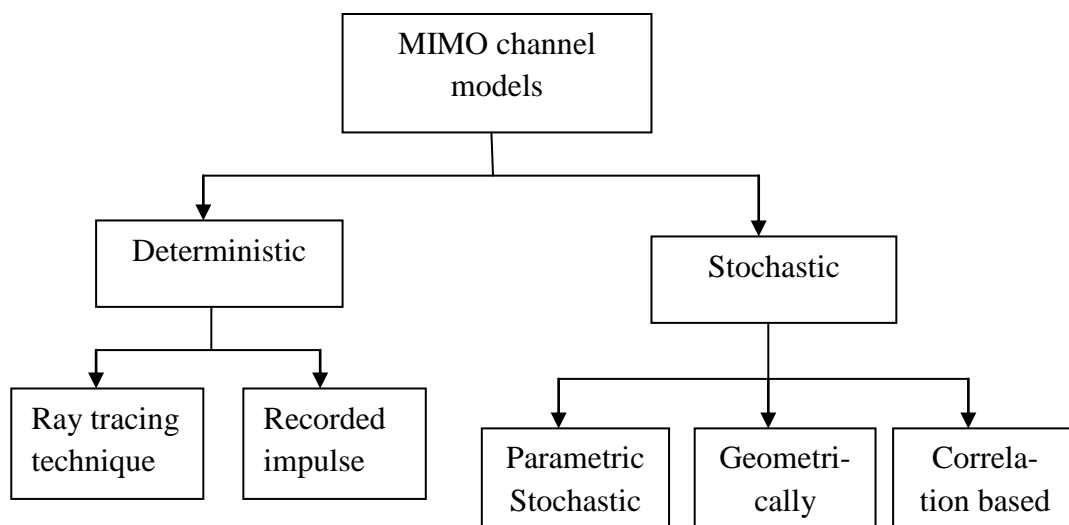

**Figure16.** MIMO channel Model classification

Among the models, the correlation based models are physical while all other models are non-physical. The main target of deterministic models is to predict the channel characteristics for a specific location by means of information from environment and the location of the transmitter and the receiver. Thus these models are only valid for specific

location and environment. On the other hand the stochastic models use the stochastic properties of the channel and are therefore more general and the same mode can be used at different location and environment i.e. urban, sub-urban and rural (Zein et al. 2009:8). The most commonly used models are discussed in this thesis.

#### 4.1.1 Ray Tracing Deterministic Model

This model is based on optical approximation and 3D description of the environment (Verma et al. 2008:1). It is able to estimate the channel characteristics accurately if complete geometrical and electromagnetically specification of the simulated environment are available and the environment is not complicated itself (Verma et al. 2008:1). This method supports only four types of components; the line of sight component, the component transmitted through obstacles, single and multiple reflection and diffraction components.

In this method the transmitting antenna are subject to reflection, scattering and diffraction at walls and edges of buildings and similar obstacles. Universal theory of diffraction and Fresnel co-efficient for reflections are used to compute the result. As the model is fully three dimensional, it provides excellent accuracy as well as additional parameters such as small-scale fading, delay and angular spreads. The model is also suitable for moving vehicular receiver (Stähler & Hoppe 2009:2272).

#### 4.1.2 One Ring Model

It is a geometrical based stochastic model which represent Rayleigh fading channel. The

Figure 17 shows a one ring model, where,

$\rho$ = the radius of the scattering ring,

$R$ = the distance from transmitter to receiver,

$$\Delta = \frac{R}{\rho} \tag{4.1}$$

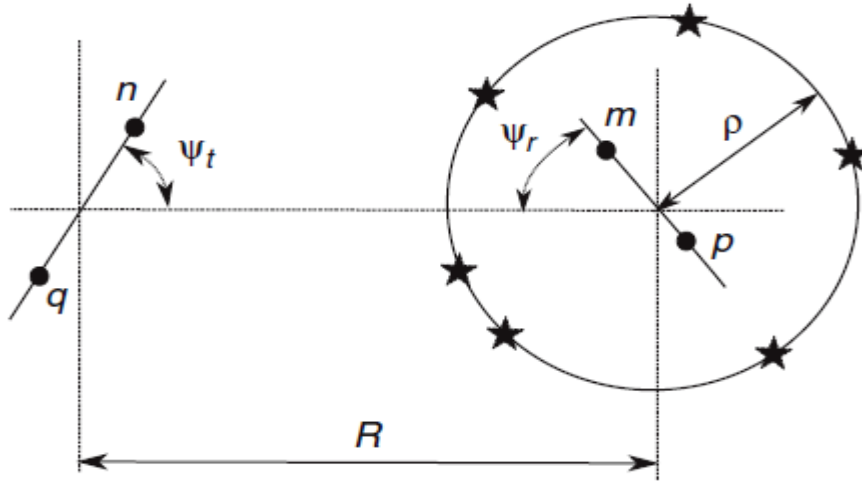

**Figure 17.** One ring model (Oestges & Clercks 2007:54).

We can consider it as ray tracing model with the following assumption (Oestges & Clercks 2007:54)

- a. Every actual scatterer is represented by a corresponding effective scatterer located at the same angle on the scatterer ring.
- b. There is no line of sight path.
- c. All rays are equal in amplitude.
- d.  $\Delta$  is large.

The correlation matrix  $R$  of the one ring model is approximated by:

$$\varepsilon\{H(n,m)H^*(q,p)\} \approx \frac{\exp[j2\pi \cos \psi + D_{np}\lambda]}{I_0(k)} \quad (4.2)$$

$$= J_0 \sqrt{k^2 - \frac{(\sin \psi_t \frac{D_{mp}}{\Delta} + \sin \psi_r D_{nq})^2 - (\cos \psi_r D_{nq})^2}{\lambda^2}} \quad (4.3)$$

Where,  $D_{mp}$  is the spacing between antennas  $m$  and  $p$ .

#### 4.1.3 Two Ring Model

This model deals with more complex situation than one ring model does. In this model both transmitter and receiver are surrounded by a scatterer ring which is shown in Figure 13.



**Figure 18:** Two ring model (Oestges & Clercks 2007:56)

The correlation matrix of two ring model can be written as

$$\varepsilon\{H(n, m)H^*(q, p)\} = J_0(2\pi\sqrt{\{D_{mp}^2 + D_{nq}^2 \pm 2D_{mp}D_{nq}\cos(\psi_t - \psi_r)\}}) \quad (4.4)$$

The main disadvantage of this model is that the channel coefficients are no longer complex Gaussian variable because all paths are scattered twice (Oestges & Clercks 2007:56)

#### 4.1.4 Correlation Based Model

Correlation based MIMO channel models are based on the channel covariance and it establish a direct link between the channel covariance matrix rank and the channel capacity. This is why it can provide more contribution in the increase of MIMO channel capacity (Alvarez et al. 2005:467)

The MIMO channel spatial correlation based model can be expressed as

$$\text{Vec}(\mathbf{H}) = \mathbf{R}^{1/2} \text{vec}(\mathbf{H}_w) \quad (4.5)$$

Where,  $\text{Vec}(\mathbf{H})$  = the column vector of matrix  $\mathbf{H}$

$\mathbf{H}_w$  = a matrix whose entries are circularly Gaussian distributed random variable with zero mean and unit variance.

The full channel covariance matrix can be expressed as, (Wood & Hodgkiss 2007:3741)

$$R = E\{vec(H)vec(H)^H\} \quad (4.6)$$

In Kronecker model, the channel matrix is expressed as:

$$R = R_{tx} \otimes R_{rx} \quad (4.7)$$

Where,  $R_{tx}$  = transmit correlation matrix,

$\otimes$  = Kronecker tensor product,

$R_{rx}$  = receive correlation matrix.

In Weichselberger model, the channel matrix is expressed as (Weichselberger, Herdin, Özcelik, & Bonek 2006:93):

$$H_{weich} = U_{rx} (\tilde{\Omega} H_w) U_{tx}^T \quad (4.8)$$

Where,  $U_{rx}$  and  $U_{tx}$  are the eigen vectors,

$\Omega$  is the coupling matrix.

$\tilde{\Omega}$  is the element wise square root of the coupling matrix  $\Omega$  and is given by (Weichselberger et al. 2006:93):

$$|\Omega|_{m,n} = W_{m,n} = E_H \left\{ \left| U_{rx,m}^H H U_{tx,n}^* \right|^2 \right\} \quad (4.9)$$

## 4.2 MIMO system Capacity

Capacity is an important tool for characterizing any communication channel and is defined as the maximum throughput at which data can be sent over the channel maintaining the error probability optimum. For conventional SISO system the Shannon capacity:

$$C = Bw * \ln [1 + SINR] \quad (4.10)$$

Where, SINR=signal to interference and noise ratio

Bw= Bandwidth

Now, consider MIMO system with M number of transmits antenna and N number of receive antenna. Assume the MIMO system is ideal, than the Shannon capacity for MIMO becomes

$$C=Bw*\ln[1+SINR*H] \quad (4.11)$$

Where, H is the MIMO capacity factor which depends on min (M, N) value.

For M=N=4 system, the capacity increases four times than the capacity of SISO system (Gogate et.al 2009). In this thesis I have discussed two types of channel capacity viz. Deterministic channel and stochastic channel.

#### 4.2.1 Deterministic Channel

The system capacity is defined as the maximum achievable error free data transmission and reception and is expressed as (Teletar 1999: 7):

$$C = \max_{f(s)} I(s; r) \quad (4.12)$$

Where,  $f(s)$  is the probability distribution of vector, s

$I(s; r)$ , is the mutual information between vector s and r

The mutual information can be expressed as (Teletar 1999: 7):

$$I(s;r) = H(r) - H(r|s) \quad (4.13)$$

Where,  $H(r)$  = the differential entropy of vector r

$H(r|s)$  = the conditional entropy of vector r given knowledge of s

Since the sending vector,  $s$  and the noise vector  $n$  are independent, so (Jankiraman 2004:22):

$$H(r|s) = H(n). \quad (4.19)$$

Thus the mutual information stands as,

$$I(s;r) = H(r) - H(n). \quad (4.20)$$

From the last equation it implies that the mutual information can be maximized by maximizing  $H(r)$

The covariance matrix of  $r$  is (Jankiraman 2004:22):

$$R_{rr} = \mathcal{E}\{rr^H\} = \frac{E_s}{M_T} HR_{ss}H^H + N_0 I_{M_R} \quad (4.21)$$

Where,  $R_{ss} = \mathcal{E}\{ss^H\}$  is the covariance matrix of  $s$ .

The differential entropy  $H(r)$  is maximum when  $r$  is zero mean circularly symmetric complex Gaussian (ZMCSCG) and if 's' is also a ZMCSCG. Thus we can find the differential entropies of  $r$  and  $n$  as (Jankiraman 2004:22):

$$H(r) = \log_2(\det(\pi e R_{rr})) \text{ bps/Hz} \quad (4.22)$$

$$H(n) = \log_2(\det(\pi e \sigma^2 I_{M_R})) \text{ bps/Hz} \quad (4.23)$$

Thus the mutual information  $I(s;r)$  reduces to (Jankiraman 2004:23)

$$I(s;r) = H(r) - H(n) = \log_2(\det(\pi e R_{rr})) - \log_2(\det(\pi e \sigma^2 I_{M_R})) \quad (4.24)$$

$$\text{Or, } I(s; y) = \log_2 \det \left( I_{M_R} + \frac{E_s}{M_T N_0} HR_{ss}H^H \right) \text{ bps/Hz} \quad (4.25)$$

Thus the capacity equation of MIMO system stands (Jankiraman 2004:23):

$$C = \max_{R_{ss} \succeq 0, \text{Tr}(R_{ss})=M_T} \log_2 \left( \det \left( I_{M_R} + \frac{E_s}{M_T N_0} HR_{ss}H^H \right) \right) \text{ bps/Hz} \quad (4.26)$$

This is the error-free spectral efficiency or data rate per unit bandwidth that could be reliably available over the MIMO link.

If our bandwidth is  $W$  Hz, then the data rate that MIMO system can provide is  $WC$  bit/s.

Now we consider two cases in channel equation development.

### Case 1: Channel unknown to the transmitter

When the channel is unknown to the transmitter, the signals are independent and the power is equally divided among different transmit antennas, so  $R_{ss} = I_{M_T}$

Thus the capacity equation stands (Jankiraman 2004:23):

$$C = \log_2 \det \left( I_{M_R} + \frac{E_s}{M_T N_0} HH^H \right) \text{bps / Hz} \quad (4.27)$$

In the last equation  $HH^H$  is Hermitian matrix which can be diagonalized using svd as:

$$HH^H = U \Lambda U^H \quad (4.28)$$

Where,  $U$  is an unitary matrix and satisfied

$$U^H U = U U^H = I_{M_R} \quad (4.29)$$

$$\Lambda, \text{ diagonal matrix} = \text{diag} (\lambda_1, \lambda_2, \dots, \lambda_{M_R}) \quad (4.30)$$

So, the capacity equation becomes (Jankiraman 2004:23):

$$C = \log_2 \det \left( I_{M_R} + \frac{E_s}{M_T N_0} U \Lambda U^H \right) \quad (4.31)$$

From determinant identity we know,

$$\det(I+AB) = \det(I+BA) \quad (4.32)$$

Using the identity, the channel equation becomes

$$C = \log_2 \det \left( I_{M_R} + \frac{E_s}{M_T N_0} \Lambda \right) \quad (4.33)$$



or,

$$C = \sum_{i=1}^r \log_2 \left( 1 + \frac{E_s}{M_T N_0} \lambda_i \right) \quad i=1,2,\dots,r \quad (4.34)$$

Where,  $r$  is the rank of the channel

$\lambda_i$  is the positive eigen value of  $HH^H$ .

From equation (4.34) we find that

$$C = \log_2 \left( 1 + \frac{E_s}{M_T N_0} \lambda_i \right) \quad , \text{ which is the capacity of SISO channel.}$$

So, we conclude that the capacity of MIMO channel is the sum of SISO channel. (Jankiraman 2004:24.)

For maximizing the capacity, the channel matrix should be orthogonal i.e.  $HH^H = \alpha I_{M_T}$  ,  $\|H_{i,j}\|^2 = 1$  (ones along the diagonal) and a full rank channel with  $M=N=r_c$ , we find (Jankiraman 2004:24)

$$C = M \log_2 \left( 1 + \frac{E_s}{M_T N_0} \right) \quad (4.35)$$

The term,  $C = \log_2 \left( 1 + \frac{E_s}{M_T N_0} \right)$  is the expression for well-known Shannon channel

Capacity (Shannon 1948).

Finally, we can conclude that the capacity of an orthogonal MIMO channel is  $M$  times higher than the scalar SISO Shannon channel capacity (Jankiraman 2004:24).

### **Case2: Channel known to the transmitter**

When the channel is known to the transmitter and the receiver end, the transmitter energy is distributed according to water-filling principle i.e. the better channel gets more; the worse channel gets less power or nothing.

Suppose, a zero mean circularly symmetric complex Gaussian signal vector 's' of dimension  $r_c \times 1$ , where  $r_c$  is the rank of the channel H.

Using svd of H i.e.  $H=U\Sigma V^H$  and multiplying output received signal by the matrix  $U^H$ , we can develop the input output relationship of the system as (Jankiraman 2004:26-27):

$$\bar{y} = \sqrt{\frac{E_s}{M_T}} U^H H V \tilde{s} + U^H n \quad (4.36)$$

$$= \sqrt{\frac{E_s}{M_T}} \Sigma \tilde{s} + \tilde{n} \quad (4.37)$$

The covariance matrix of noise vector:

$$E\{\tilde{n}\tilde{n}^H\} = N_0 I_r \quad (4.38)$$

$$\text{The signal vector } \tilde{s} \text{ satisfies, } E\{\tilde{s}\tilde{s}^H\} = M_T \quad (4.39)$$

When channel is known at the transmitter, the channel matrix H can be decomposed in r parallel SISO channel, i.e.

$$\bar{y}_i = \sqrt{\frac{E_s}{M_T}} \sqrt{\lambda_i} \tilde{s}_i + \tilde{n}_i \quad i=1,2, \dots \quad (4.40)$$

It is seen that the MIMO channel capacity is the sum of SISO channel capacity and can be expressed as (Jankiraman 2004:24):

$$C = \sum_{i=1}^r \log_2 \left( 1 + \frac{E_s \gamma_i}{M_T N_0} \lambda_i \right) \quad (4.41)$$

$$\text{Where, } \gamma_i = C\{|s_i|^2\} \quad i=1,2,3, \dots \quad (4.42)$$

To maximize the capacity, we have (Jankiraman 2004:24-26):

$$C = \max_{\sum_{i=1}^r \gamma_i} \sum_{i=1}^r \log_2 \left( 1 + \frac{E_s \gamma_i}{M_T N_0} \lambda_i \right) \quad (4.43)$$

By Lagrangian method, the optimal energy can be obtained and it is:

$$\gamma_i^{opt} = \left( \pi - \left( \frac{E_s}{M_T N_0} \lambda_i \right)^{-1} \right) \quad (4.44)$$

Or

$$\gamma_i^{opt} = \left( \pi \left( \pi \frac{E_s}{M_T N_0 \lambda_i} \right) \right) \tag{4.45}$$

$$\sum_{i=1}^r \gamma_i = M_T \tag{4.46}$$

Where,  $\mu$  is constant and can be calculated as (Jankiraman 2004:26):

$$\pi = \frac{M_T}{(r-p+1)} \left[ 1 + \frac{N_0}{E_s} \sum_{i=1}^{r-p+1} (\lambda_i)^{-1} \right] \tag{4.47}$$

Where, P is the iteration count from 1 to  $\alpha$ .

All negative power allocation is discarded by setting  $\gamma_{r/p-1}^{opt} = 0$  and the algorithm is continued with increment of P.

This algorithm concentrates on better channel and allocates more power to those while rejects or allocates less power to the worse channel.

$\frac{M_T N_0}{E_s \lambda_i}$	
$\frac{M_T N_0}{E_s \lambda_{i-1}}$	
.....	
$\gamma_3^{opt}$	$\frac{M_T N_0}{E_s \lambda_3}$
$\gamma_2^{opt}$	$\frac{M_T N_0}{E_s \lambda_2}$
$\gamma_1^{opt}$	$\frac{M_T N_0}{E_s \lambda_1}$

**Figure 19** Schematic of water-filling algorithm (Jankiraman 2004:27)

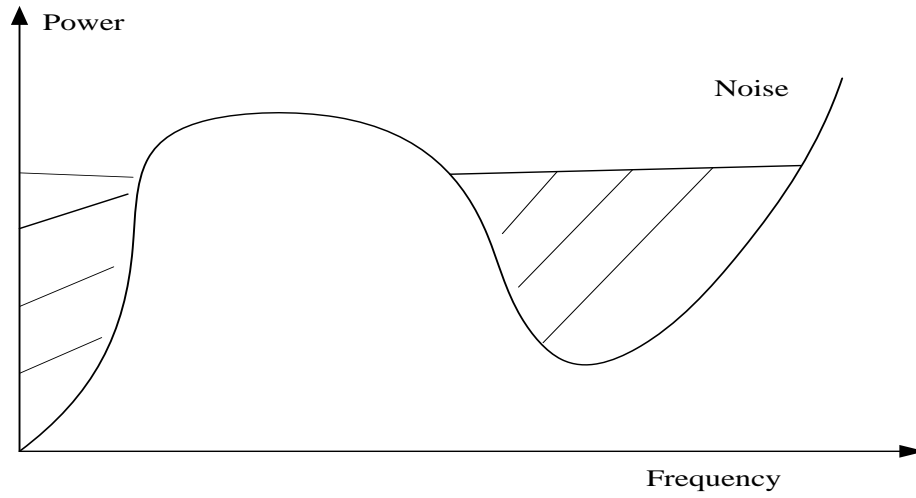

**Figure 20.** Notional water filling example (Bliss et al. 2005: 99)

**SIMO channel capacity:**

In SIMO,  $M_T=1$  and the channel matrix is a column matrix i.e.

$$H = \begin{bmatrix} h_1 \\ h_2 \\ \cdot \\ \cdot \\ h_{M_R} \end{bmatrix} = [h_1 \quad h_2 \quad \cdot \quad \cdot \quad h_{M_R}]^T \quad (4.48)$$

$M_R > M_T$  (as  $M_T=1$ )

We get the capacity equation as (Jankiraman 2004:27):

$$C = \log_2 \det \left( I_{M_T} + \frac{E_s}{M_T N_0} H^H H \right) \quad (4.49)$$

Since,  $H^H H = \sum_{i=1}^{M_R} |h_i|^2$  and  $M_T=1$ , we get

$$C = \log_2 \det \left( 1 + \sum (h_i)^2 \frac{E_s}{N_0} \right) \quad (4.50)$$

Assume the channel matrix elements are equal and normalized as

$$|h_1|^2 = |h_2|^2 = \dots = |h_{M_R}|^2 = 1 \quad (4.51)$$

Then the channel capacity (channel is unknown at transmitter) is (Jankiraman 2004:27):

$$C = \log_2 \det \left( 1 + M_R \frac{E_s}{N_0} \right) \quad (4.52)$$

It is seen that the channel capacity increases logarithmically as the number of receive antenna. However, the knowledge of transmitter does not provide any extra benefit.

### **MISO channel capacity:**

In MISO channel,  $M_R=1$  and the channel matrix is a row matrix i.e.

$$H = [h_1 \quad h_2 \quad \dots \quad h_{M_R}] \quad (4.53)$$

$$HH^H = \sum_{j=1}^{M_T} |h_j|^2$$

Thus, the capacity equation of SIMO can be developed as (Jankiraman 2004:28):

$$C = \log_2 \left( 1 + \frac{E_s}{N_0} \right) \quad (4.54)$$

So we can conclude that when the channel knowledge is unknown at transmitter, there is no capacity increase for multiple transmit antenna (no transmit diversity).

When the channel is known at the transmitter, the capacity equation becomes (Jankiraman 2004:28-29):

$$C = \log_2 \left( 1 + M_T \frac{E_s}{N_0} \right) \quad (4.55)$$

In both MISO and SIMO system there is only one path from transmitter to receiver to pass signal. These systems provide only one data pipe, hence can't increase system capacity. On the other hand in MIMO even we use at least 2 transmit and 2 receive antennas, it can provide multiple data pipes and obviously doubles the system capacity.

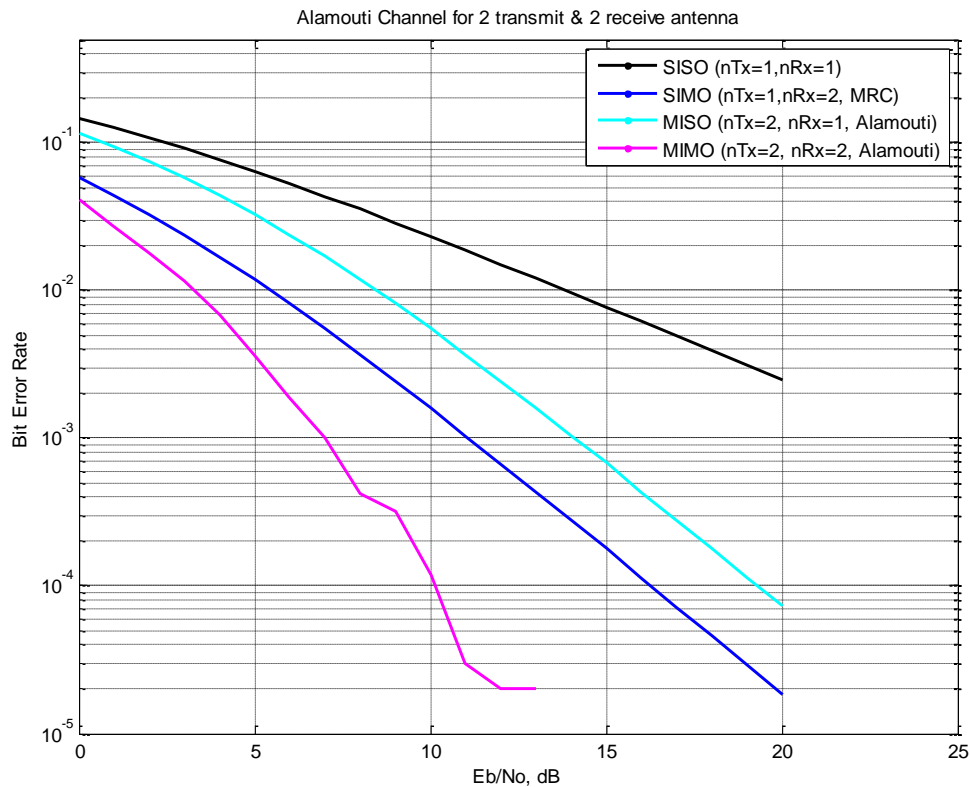

**Figure 21.** BER for SISO, MISO, SIMO and MIMO channel (Pillai 2009)

#### 4.2.2 Random Channel

In this type of transmission, the channel matrix is chosen randomly according to Rayleigh distribution.

Two capacity values can be calculated in random channels.

1. The Ergodic channel capacity and
2. The outage channel capacity.

The Ergodic capacity of a MIMO channel is the average information rate of the whole channel matrix  $H$ . In it every element of channel matrix  $H$  is considered to be independent. The capacity of an  $N_R \times N_T$  MIMO channel with perfect channel state information is (Oestges & Clercks 2007: 113-114):

$$C_{CSIT}(H) = \max_{Q>0: \text{Tr}\{Q\}=1} \log_2 \det \left[ I_{N_r} + \frac{E_s}{\sigma_N^2} H Q H^H \right] \quad (4.56)$$

Where,  $\frac{E_s}{\sigma_N^2}$  is the SNR,

Q, is the covariance matrix =  $\frac{I_{N_T}}{N_T}$

The optimum Q is obtained as

$$Q^{opt} = V_H \text{diag}\{P_1^*, P_2^*, \dots, P_N^*\} V_H^H \quad (4.57)$$

$$\text{Where, } H = V_H \sum_H V_H^H \text{ and } \sum_H = \text{diag}\{\delta_1, \delta_2, \dots, \delta_N\} \quad (4.58)$$

The capacity stands as:

$$C_{CSIT}(H) = \max_{\{P_k\}_{k=1}^N} \sum_{K=1}^N \log_2 \left( 1 + \frac{E_s}{\sigma_N^2} P_K \lambda_K \right) \quad (4.59)$$

$$C_{CSIT}(H) = \sum_{K=1}^N \log_2 (1 + \rho P_K^* \lambda_K) \quad (4.60)$$

Where,  $\frac{E_s}{\sigma_N^2} = \rho$

Now consider power allocation strategy,

$$\{P_1, P_2, \dots, P_N\} = \{P_1^*, P_2^*, \dots, P_N^*\} \quad (4.61)$$

and

$$\text{The power constraint } \sum_{K=1}^N P_K^* = 1 \quad (4.62)$$

For maximizing capacity by using water-filling algorithm, we have

$$P_K^* = \left( \mu - \frac{1}{\rho \lambda_K} \right)^+ \quad (4.63)$$

Where,  $K= 1,2,\dots N$

The '+' sign indicates that we are interested only positive power level.

In Equation (4.63),  $\mu$  is a constant and is calculated as

$$\mu(j) = \frac{1}{N - j + 1} \left(1 + \sum_{k=1}^N \frac{1}{\rho \lambda_k}\right) \quad (4.64)$$

Where,  $j$  is a iteration number i.e  $j=1,2,\dots,\alpha$

On the other hand ergodic capacity of an  $N_R \times N_T$  MIMO channel without or with partial transmit channel knowledge is (Oestges & Clercks 2007: 194):

$$C_{CDIT}(H) = \max_{Q>0:Tr\{Q\}=1} \mathcal{E} \left\{ \log_2 \det \left[ I_{N_R} + \frac{E_s}{\sigma_N^2} H Q H^H \right] \right\} \quad (4.65)$$

Since, the channel  $H$  is random; the information associated with it also must be random.

So the expectation operator ( $\mathcal{E}$ ) is applied in the above equation.

At low SNR region, the transmit channel knowledge is beneficial; the capacity is higher than the capacity with partial or without channel knowledge. But at high SNR, the capacity is almost same i.e. independent of channel knowledge.

### Outage Capacity:

Outage capacity is defined as the probability that a given channel realization can not support a given rate. 10% outage capacity means as the information rate that is guaranteed for (100-10) % of the channel realization. The capacity increases as the increase of either or both the SNR and the number of antennas. Mathematically we can write (Oestges & Clercks 2007: 141):

$$\frac{1}{M} H_w H_w^H \rightarrow I_M \text{ as } M \rightarrow \alpha \quad (4.66)$$

Where,  $I_M$  is the mutual Information

$$\text{And, } C \rightarrow M \log_2(1 + \rho) \quad (4.67)$$



Where,  $\rho$  is the SNR

### 4.3 Capacity Limits of MIMO channel

The channel capacity gain obtained from multiple antennas is less or more affected by a number of factors and ultimately the gain is reduced. These includes the available channel information at transmitter and/or receiver end, the channel signal to noise ratio, free space propagation, the presence of line of sight, Rician fading, key holes, limited number of scatters, the correlation between the channel gain on each antenna element (Goldsmith, Jafar, Jindal, & Vishwanath 2003:604; Salous 2009).

Correlation of the channel matrix is due to small spread at the transmitter or receiver, distance between transmitter and receiver, separation between antenna elements and antenna geometry. It sometime increase capacity and sometime decreases it (Goldsmith 2003 et al. 2003:604). For a deterministic channel the correlation can be used to measure capacity of MIMO channel. For a random channel the mean correlation equals zero and is not suitable for capacity, instead a low correlation is fruitful. To ensure an uncorrelated (i.i.d) channel matrix, the antennas should be separated at least by a half wavelength (Salous 2009).

This requirement needs considerable space on the user unit and still a number of antenna need to be crammed in that small space with possible different polarization. The effect is that coupling (when several antenna elements are located closely together, the electric field of one antenna alters the current distribution of other antenna.) between antennas is increased. In rich i.i.d environment, coupling degrades the performance. For intermediate i.i.d environment coupling can reduce the correlation between antenna elements. For a linear array, the correlation does not affect the channel capacity only if the separation distance between the antenna elements follows (Salous 2009):

$$d < \frac{\lambda}{2\Delta \cos \varphi} \quad (4.68)$$

where,  $\lambda$  = wavelength,  $\phi$ =average angle of arrival  $\Delta$ =  
angular spread

Obviously, the capacity is reduced for small angular spread. As the angular spread goes high, the capacity increases.

The rank of channel matrix and hence the channel capacity is heavily depends on the number of scatterers (Salous 2009).The capacity equation can be expressed counting this affect as

$$C = \sum_{i=1}^{N_s} \log_2[1 + \rho N_T (\gamma_i)^2] \quad (4.69)$$

Where,  $N_s$ = no. of scatterers  $N_T$ = no. of transmit antenna

$\gamma_i$  = gain of the  $i$ th multipath component.

Channel with very low correlation or even un-correlated suffers from rank deficiency. This effect is known as key hole effect. If the determinant of channel matrix  $H$  is zero, it can give only one degree of freedom and can't provide two or more data streams. In MIMO system, at least two data stream is necessary to provide high data rate. Usually, horizontal polarization antenna is used to reduce key hole effect. (Salous 2009.)

MIMO system capacity in free space depends on polarization, inter-element separation and array orientation.

In free space, with small distance between transmitter and receiver antenna, the system provides higher capacity than the median capacity of Gaussian channels. This is because of the availability of sufficient different amplitude and phase. Again when the antenna elements are spaced wide apart, the channel capacity remains high for a long range of transmitter-receiver separation. However the spacing is; at large distance the system capacity saturates to a minimum capacity. (Kyritsi 2002: 183.)

In LOS propagation channels, all the elements of channel matrix,  $H_{LOS}$  is considered as identical, thus results the channel matrix as a rank-one matrix. The capacity equation becomes (Jaouhar , Hutter & Farserotu 2002:403).

$$C_{LOS} = \log_2 \{ \det [ I_N + (\frac{\rho}{N} H_{LOS} H_{LOS}^H) ] \} = \log_2 \{ 1 + N\rho \} \quad (4.70)$$

$$\text{Where, } H_{LOS} H_{LOS}^H = I_N \quad (4.71)$$

The capacity is increased logarithmically with the number of antenna elements.. The capacity gain is due to SNR. When the antenna arrays at the transmitter and receiver is uncorrelated, the Equation (4.70) becomes (Jaour et al. 2003:403):

$$C_{LOS} = \log_2 \{ \det [ I_N + (\frac{\rho}{N} H_{LOS} H_{LOS}^H) ] \} = N \log_2 \{ 1 + \rho \} \quad (4.72)$$

$$\text{Where, } H_{LOS} H_{LOS}^H = NI_N$$

Now the capacity increase linearly with the number of antenna elements.

In Rician channel, the deterministic channel component and the stochastic channel component co-exists. The normalized channel matrix is (Driessen & Foschini 1999: 175):

$$H_{Ric} = aH_{LOS} + bH_{LOS} = \sqrt{\frac{k}{k+1}} H_{LOS} + \frac{1}{\sqrt{k+1}} H_{Ray} \quad (4.73)$$

Where,  $a^2 + b^2 = 1$ , a and b are scalar

$a^2$  = power of deterministic component

$b^2$  = power of stochastic component

$$k = \text{Rician factor} = \frac{a^2}{b^2} \quad (4.74)$$

For pure deterministic channel  $k \rightarrow \infty$  and for pure Rayleigh channel  $k \rightarrow 0$

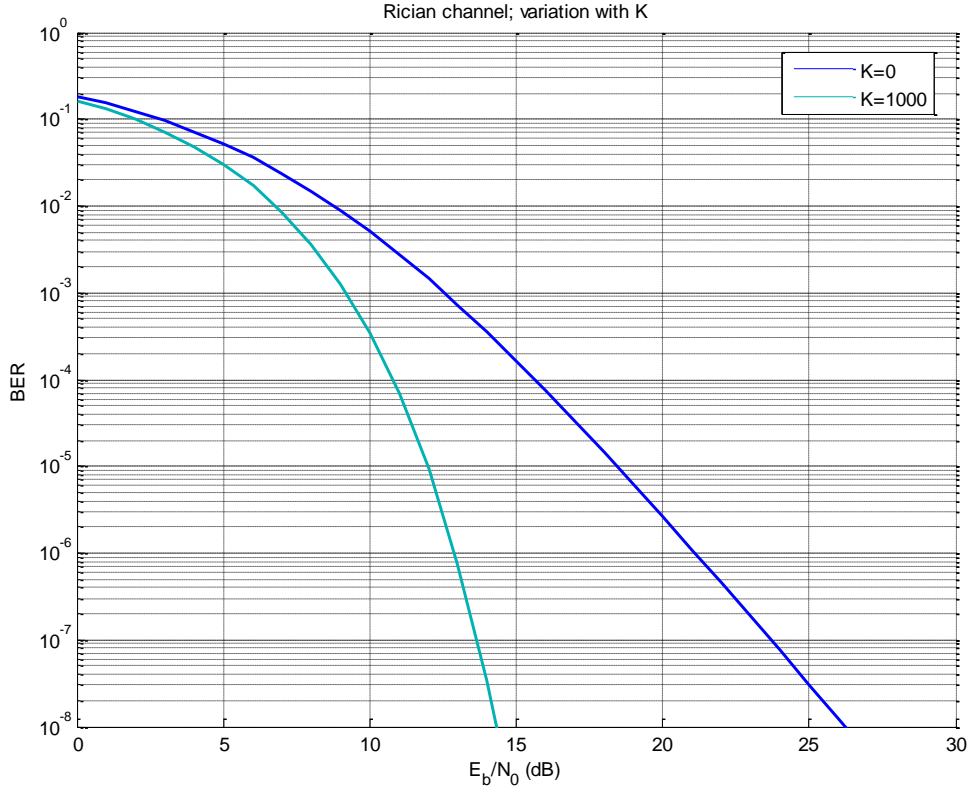

**Figure 22.** Bit error rate varies on Rician factor,  $k$ .

The capacity of Rician channel matrix is expressed as (Jaour et al. 2003:403)

$$C_{Ric} = \log_2 \left\{ \det \left[ I_N + \left( \frac{\rho}{N} H_{Ric} H_{Ric}^H \right) \right] \right\} \quad (4.75)$$

$$= \sum_{i=1}^n \log_2 \left\{ 1 + \frac{\rho}{n} \lambda_i \right\} \quad \lambda_i = \text{eigen value} \quad (4.76)$$

$$= \sum_{i=1}^n \log_2 \left\{ 1 + \frac{\rho}{n} |s_i|^2 \right\} \quad S_i = \text{singular value} \quad (4.77)$$

When the antenna spacing is less than a wave-length the capacity reduces. To obtain high capacities for Rician channels, the elements of array should be spread out either by transmitting from different location (explicit) or by adding reflectors to create images (implicit)(Salous 2009).

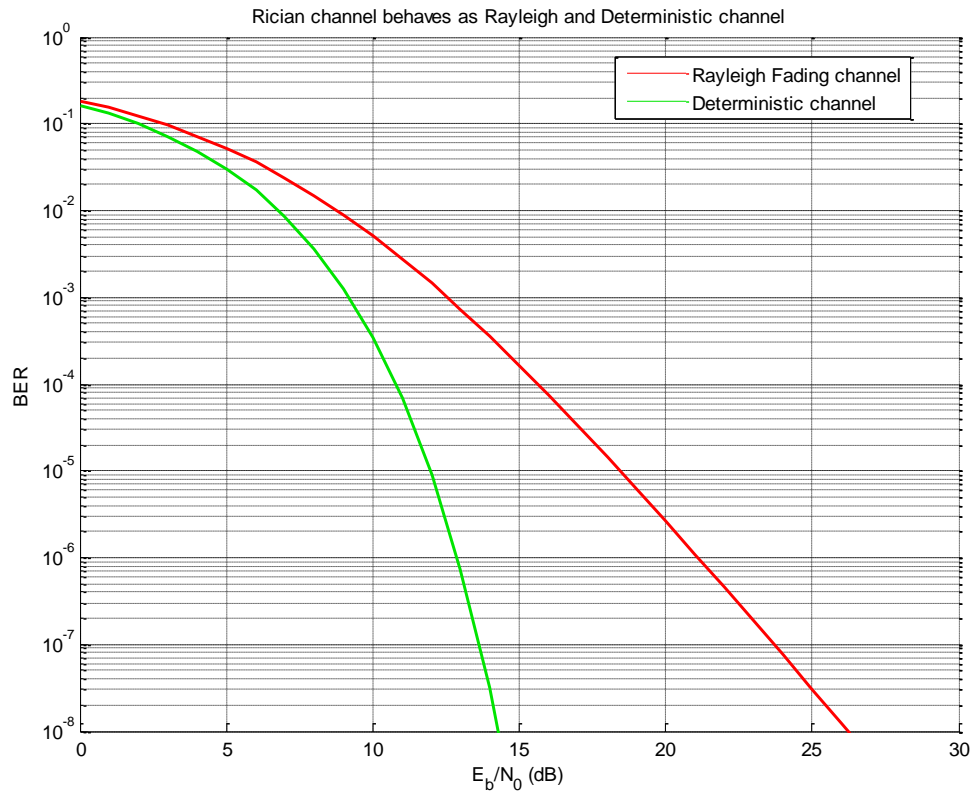

**Figure 23.** Rayleigh and Deterministic channel behave same as Rician channel with factor  $k=0$  and  $k=1000$  respectively.

#### 4.4 Singular Value Decomposition

The SVD is a very powerful and widely used techniques dealing with set of equations or matrices those are either singular or close to singular. It decomposes a matrix into several different matrices and reduces a data set containing a large number of values. (Bapat 2000: 89).

Any  $m \times n$  rectangular matrix  $H$  ( $m \geq n$ ) can be expressed as the product of  $m \times n$  column-orthogonal matrix  $U$ , an  $n \times n$  diagonal matrix  $D$  with positive or zero elements and the transpose of an  $n \times n$  orthogonal matrix  $V$ .

If  $H$  is real, then we can write

$$H=UDV^T \quad (4.78)$$

Where, U and V is unitary matrix defined as :

$$U^{-1}=U^T, \quad V^{-1}=V^T \quad \text{and} \quad UU^T=VV^T=1 \quad (4.79)$$

$$D(\text{diagonal matrix}) = \begin{bmatrix} D_1 & 0 & 0 & 0 & 0 \\ 0 & D_2 & 0 & 0 & 0 \\ \cdot & \cdot & \cdot & \cdot & \cdot \\ \cdot & \cdot & \cdot & \cdot & \cdot \\ 0 & 0 & 0 & 0 & D_i \end{bmatrix} \quad (4.80)$$

$$D_1, D_2, \dots, D_i \geq 0 \quad (4.81)$$

If H is complex then

$$H=UDV^H \quad (4.82)$$

Where,  $V^H$  is Hermitian (complex conjugate) transpose of matrix V

Using SVD in Gaussian flat-fading MIMO equation i.e.  $Y=Hx+n$ , we can write

$$Y = UDV^T X \quad (\text{ignoring noise}) \quad (4.83)$$

Multiplying both sides by  $U^T$ , we have

$$U^T Y = U^T U D V^T X \quad (4.84)$$

Since, U is unitary, so  $U^T U = 1$

$$\text{Thus, } U^T Y = D V^T X \quad (4.85)$$

Let  $\tilde{Y} = U^T X$  and  $\tilde{X} = V^T X$

$$\text{So, } \tilde{Y} = D \tilde{X} \quad (\text{Bapat 2000: 89-100}) \quad (4.86)$$

Thus the MIMO output can be expressed as the multipliers of diagonal matrix. The number of non-zero element of diagonal matrix is the rank of the channel matrix. If the rank is M, the MIMO channel is equivalent to M number parallel SISO channel. This means, svd simplifies the MIMO channel calculation. The svd can be calculated easily

by using MatLab software in very simple way. Suppose H is a random channel matrix of dimension  $3 \times 4$ . We like to find the equivalent parallel channel model for a MIMO. First we find svd of matrix H using Matlab.

```
>>H=[rand(3,4)];
```

```
>>[U,D,V]=svd(H)
```

U =

```
-0.7019  0.2772  0.6561
-0.5018  0.4613 -0.7317
-0.5055 -0.8428 -0.1847
```

D =

```
2.1610    0    0    0
    0  0.9790    0    0
    0    0  0.5542    0
```

V =

```
-0.5047  0.5481 -0.2737  0.6082
-0.4663  0.4726  0.2139 -0.7165
-0.4414 -0.4878 -0.7115 -0.2469
-0.5770 -0.4882  0.6108  0.2360
```

From the above result, it is found that there are three nonzero singular values, thus the model should have three parallel channels. The gains are in diminishing order i.e. the first channel has the maximum gain and the last one has zero gain.

## 5. SIMULATIONS AND RESULTS

In order to study the capacity behavior of MIMO channel, we carried out the following assumption in our simulation.

- a. The channel is unknown to the transmitter.
- b. The power is equally divided among different transmit antennas.
- c. Channel matrices are orthogonal i.e.  $\mathbf{H}\mathbf{H}^H = \alpha \mathbf{I}_{M_T}$ .
- d.  $\|\mathbf{H}_{i,j}\|^2 = 1$  (ones along the diagonal)
- e. a full rank channel with  $N_T = N_R = M = r_c$  (full rank) and
- f. Bandwidth,  $B=1$

We have used the following equation for calculating capacities.

$$C = M * B * \log_2(1 + \text{SNR})$$

The Figure 24 shows the channel capacities of different number of antenna used in the MIMO system. It is clearly seen in the plot that the capacity increases as the number of antenna increases. The result is also compared to the Shannon capacity.



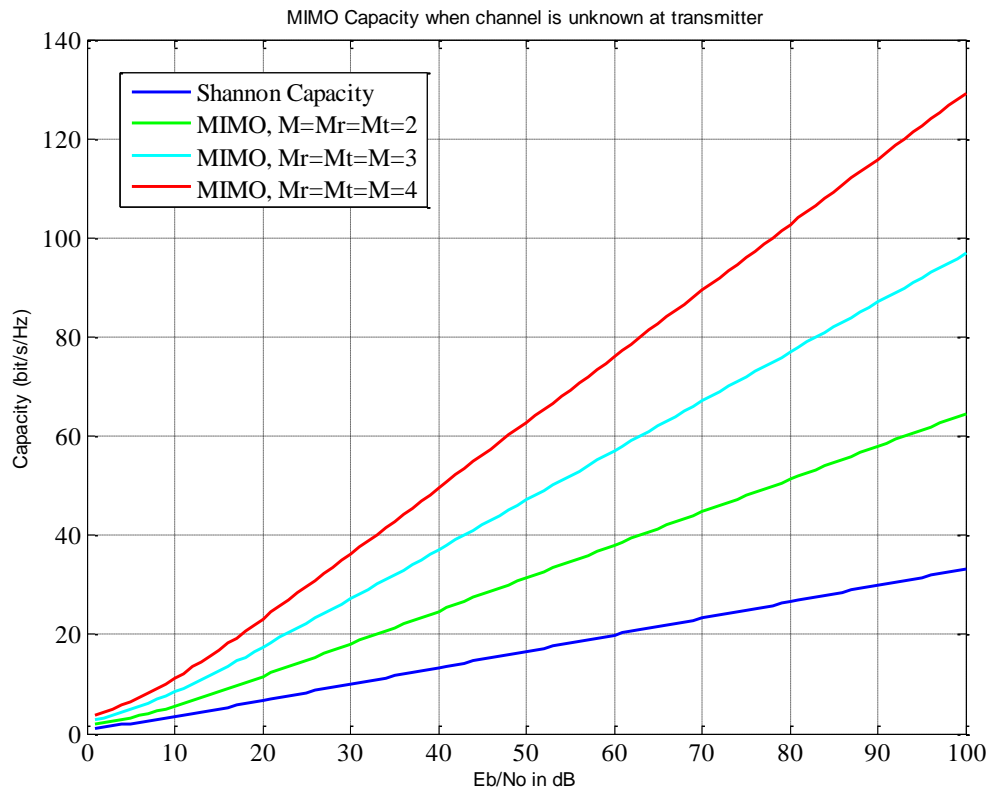

**Figure 24.** Capacity versus Eb/No plot for different number of antennas.

## 6. CONCLUSION

In this thesis, we have studied some essentials of MIMO wireless systems. The demand for frequency spectrum is increasing day by day. In the near future there would be huge jamming in wireless communication. Some reasons are, long distance wireless data networks (e.g. WiMAX, LTE, etc.), high speed WiFi deployment, wireless sensor networks, networked homes, wireless automation, and many others. Advanced wireless technology has been also developing very well. One major constraint is the available spectrum bandwidth. The spectrum is limited resource where the demand is much more than the supply. Moreover, the antenna size and the transmit power are limited in order to reduce the interference. The wireless communication is further limited by multipath fading. MIMO may introduce powerful solution for some of those problems with reasonable complexity and cost. An effective and adaptive MIMO can be used to mitigate the spectrum scarcity by increasing the data rate. MIMO not only increases the data rate but it also resists fading, increases capacity, increases coverage, improves spectral efficiency, reduces power consumption and reduces the cost of wireless network. The performance of MIMO depends on suitable MIMO channel model, space time coding and capacity equation constraints.

A powerful signaling technique is necessary to improve the robustness of the communication link. Through our study, it has been found that no single coding technique is enough for providing maximum channel capacity. Spatial multiplexing supports high data rate but fails to control transmit diversity. OSTBCs provide the full diversity but suffer from a limited spatial multiplexing rate. Linear dispersion codes provide high data rate as well as maintain full transmit diversity. The algebraic and LDCs make the receiver very complex. STTC provide full diversity and coding gain but its decoding technique is relatively complex.

MIMO modeling is important for effective MIMO system design. The 3 dimensional rays tracing deterministic model has been found better for MIMO channel system. The expression for different MIMO channel capacity with multiple transmit antenna and

multiple receive antenna have been analyzed. The optimum transmit power allocation in parallel channel has been obtained according to the water filling algorithm. It has been found that by using the spatial dimension of a communication link, the MIMO system can provide higher data rates than the traditional SISO channels. We have found multiple methods to approximate the maximum channel capacity of a MIMO system. It seems the one of the most important economical ways to increase data rate and the QoS. Using multipath transmission signal, MIMO increases the chance that any given path will reach the destination, which improves link reliability.

The available channel information at transmitter and/or receiver end, the channel signal to noise ratio, free space propagation, the presence of line of sight, Rician fading, key holes, limited number of scatters and the correlation between the channel gains on each antenna element are the major factors affecting the channel capacity.

Some major challenges for MIMO systems are increased processor energy consumption, inter-user interference in multi-user MIMO, frequency selective fading channel, CSI feedback rates and fair scheduling option in multi-user environment. The MIMO technique is already adopted with Wi-Fi and Wimax technology and also viable for 3G and LTE technology.

A combination of OFDM and MIMO is highly potential for future 4G mobile communication environment and urges future research.

## REFERENCES

- Alamouti, Siavash M. (1998) . *A Simple Transmit Diversity Technique for Wireless Communications*. IEEE Journal on Select Areas in Communications, Vol. 16, No. 8, 1211 – 1226.
- Alvarez , V. Rivera, D. Torres-Román & V. Kontorovitch(2005). *On MIMO Space-Time Coded Systems: Unleashing the Spatial Domain*. 2nd International Conference on Electrical and Electronics Engineering (ICEEE), 467 – 470.
- Andrews, Jeffrey G., Arunabha Ghosh & Rias Muhamed (2007). *Fundamentals of WiMAX : understanding broadband wireless networking* . New Jersey: Pearson Education, Inc.
- Bapat, R. B. (2000). *Linear Algebra & Linear Models*. New York: Springer-Verlag, Incorporated, 89-100.
- Bliss, Daniel W., Keith W. Forsythe & Amanda M. Chan (2005). *MIMO Wireless Communication*. Lincoln Laboratory Journal, Vol. 15, No. 1, 97 – 126.
- Driessen, P. F. & G. J. Foschini (1999). *On the Capacity Formula for Multiple Input Multiple Output Wireless channels: a geometric interpretation*. IEEE Transactions on Communications, Vol. 47, Issue: 2, 173 – 176.
- Gilbert ,Jeffrey M. ,Won-Joon Choi & Qinfang Sun (2005) [on line ][cited 2009-09-27]. *MIMO Technology for Advanced Wireless Local Area Networks*. Available: <<http://www.atheros.com>>
- Gogate, Vidya, Shikha Nema, R. P. Singh & Aditya Goel (January, 2009). *A Capacity Analysis of MIMO OFDMA for 4G Cellular System Design*. International Conference on Advances in Computing, Communication and Control (ICAC3'09)

Goldsmith, Andrea (2005). *Wireless Communications*. New York: Cambridge University Press.

Goldsmith, Andrea, Syed Ali Jafar, Nihar Jindal, & Sriram Vishwanath (2003). *Capacity Limits of MIMO Channels*. IEEE Journal On Selected Areas In Communications, Vol. 21, No. 5, 604 – 702.

Hassibi, B. & B. Hochwald (2001). *High-Rate Linear Space-Time Codes*. IEEE Selected Journal, Vol. 4, 2461-2464.

Heath, Robert W (2009). *Antenna design and analysis for MIMO communication system* [on line ][cited 2009-09-27]. Available from internet: <<http://users.ece.utexas.edu/~rheath/research/mimo/antenna>>

Jankiraman, Mohinder(2004) . *Space-Time Codes and MIMO Systems*. London: Artech House, Incorporated.

Jaouhar , Ayadi , Andreas A. Hutter & John Farserotu(2002). *On the Multiple Input Multiple Output Capacity of Ricean Channels*. The 5th International Symposium on Wireless Personal Multimedia Communications, Vol. 2, 402 –406.

Kermoal , Jean Philippe, Laurent Schumacher, Klaus Ingemann Pedersen, Preben Elgaard Mogensen, & Frank Frederiksen (2002). *A Stochastic MIMO Radio Channel Model with Experimental Validation*. IEEE Journal on Selected Areas in Communications, Vol. 20, No. 6, 1211 – 1226.

Kyritsi , Persefoni (2002). *MIMO Capacity in Free Space and Above Perfect Ground: Theory and Experimental Results*. The 13th IEEE International Symposium on Personal, Indoor and Mobile Radio Communications, Vol. 1, 182 - 186.

Mietzner,Jan , Robert Schober, Lutz Lampe, Wolfgang H. Gerstacker, & Peter A. Hoeher (2009). *Multiple-Antenna Techniques for Wireless Communications – A*

*Comprehensive Literature Survey*. IEEE Communications Surveys & Tutorials, Vol. 11, No. 2, 87 – 105.

Oestges , Claude & Bruno Clerckx (2007). *MIMO Wireless Communications: From Real-World Propagation to Space-Time Code Design*. London: Elsevier, Academic Press.

Pillai, Krishna (2009). [on line ][cited 2009-09-27]. Alamouti STBC with 2 receive antenna. Available: <<http://www.dsplog.com>>

Salous, Sana. *The Provision of an Initial Study of Multiple In Multiple Out Technology* [online] [cited 2009-09-15]. Available from Internet: < [www.ofcom.org.uk/static/archive/ra/topics/research/topics/.../mimo.pdf](http://www.ofcom.org.uk/static/archive/ra/topics/research/topics/.../mimo.pdf) >

Shannon, C. E (1948). *A Mathematical Theory of Communication*. Bell System Technical Journal, vol. 27, 379-423.

Stähler, Oliver & Reiner Hoppe (2009). *MIMO Channel Capacity Computed with 3D Ray Tracing Model*. The 3<sup>rd</sup> European Conference on Antennas and Propagation, 2271-2275

Telatar, I. Emre (1999). *Capacity of Multi-antenna Gaussian Channels*. *European Transactions on Telecommunications*, Vol. 10, No. 6, 585-595.

University of California, Los Angeles (UCLA) (2009)[on line ][cited 2009-09-27]. *Non-Engineer's Introduction to MIMO & OFDM*. Available from internet: <<http://www.mimo.ucla.edu>>

Varshney, D., C. Arumugam, V. Vijayaraghavan, N. Vijay & S.Srikanth (2003). *Space-Time Codes in Wireless Communications*. IEEE Potentials, Vol.22, Issue 3, 36-38.

- Verma, Rashmi, Shilpa Mahajan & Vishal Rohila (2008). *Classification of MIMO Channel Models*. The 16th European Conference on Networks, 1-4.
- Weichselberger, Werner, Markus Herdin, Hüseyin Özcelik, & Ernst Bonek(2006). A *Stochastic MIMO Channel Model With Joint Correlation of Both Link End*. IEEE Transactions on Wireless Communications, Vol. 5, No. 1, 90 – 100.
- Wood , Leslie C. & William S. Hodgkiss (2007). *MIMO Channel Models and Performance Metrics*. IEEE Global Telecommunications Conference, 3740 – 3744.
- Zein , Ghais El , Hanna Farhat , Patrice Pajusco , Jean-Marc Conrat , Yves Lostanlen Rodolphe Vauzelle & Yannis Pousset (2009). *Characterization, Modeling and Simulation of the MIMO Propagation Channel*. Belgium: Elsevier Masson SAS. Comptes Rendus Physique, Vol. 11, Issue. 1, 7-17.
- Zubala, Rafał , Hubert Kokoszkiewicz, B.W.Martijn Kuipers and Lu'is M. Correia (2006). *A Simple Approach to Mimo Channel Modelling*. 14th European Signal Processing Conference (EUSIPCO 2006), Florence, Italy.