



Vaasan yliopisto
UNIVERSITY OF VAASA

OSUVA Open
Science

This is a self-archived – parallel published version of this article in the publication archive of the University of Vaasa. It might differ from the original.

Review on the Energy Storage Technologies with the Focus on Multi-Energy Systems

Author(s): Vahid-Ghavidel, Morteza; Javadi, Sara; Gough, Matthew; Javadi, Mohammad S.; Santos, Sérgio F.; Shafie-khah, Miadreza; Catalão, João P.S.

Title: Review on the Energy Storage Technologies with the Focus on Multi-Energy Systems

Year: 2022

Version: Accepted manuscript

Copyright ©2022 Wiley. This is the peer reviewed version of the following article: Vahid-Ghavidel, M., Javadi, S., Gough, M., Javadi, M. S., Santos, S. F., Shafie-khah, M. & Catalão, J. P.S. (2022). Review on the Energy Storage Technologies with the Focus on Multi-Energy Systems. In: Graditi, G. & Di Somma, M. (eds.) *Technologies for Integrated Energy Systems and Networks*, 105-122, which has been published in final form at <https://doi.org/10.1002/9783527833634.ch5>. This article may be used for non-commercial purposes in accordance with Wiley Terms and Conditions for Use of Self-Archived Versions. This article may not be enhanced, enriched or otherwise transformed into a derivative work, without express permission from Wiley or by statutory rights under applicable legislation. Copyright notices must not be removed, obscured or modified. The article must be linked to Wiley's version of record on Wiley Online Library and any embedding, framing or otherwise making available the article or pages thereof by third parties from platforms, services and websites other than Wiley Online Library must be prohibited.

Please cite the original version:

Vahid-Ghavidel, M., Javadi, S., Gough, M., Javadi, M. S., Santos, S. F., Shafie-khah, M. & Catalão, J. P.S. (2022). Review on the Energy Storage Technologies with the Focus on Multi-Energy Systems. In: Graditi, G. & Di Somma, M. (eds.) *Technologies for Integrated Energy Systems and Networks*, 105-122. Weinheim: Wiley.
<https://doi.org/10.1002/9783527833634.ch5>

Review on the Energy Storage Technologies with the Focus on Multi-energy Systems

Morteza Vahid-Ghavidel^{1,2}, Sara Javadi³, Matthew Gough^{1,2}, Mohammad Sadegh Javadi², Sérgio F. Santos^{2,4}, Miadreza Shafie-khah³, and João P.S. Catalão^{1,2,*}

¹ Faculty of Engineering, University of Porto (FEUP), 4200-465 Porto, Portugal

² Institute for Systems and Computer Engineering, Technology and Science (INESC TEC), 4200-465 Porto, Portugal

³ School of Technology and Innovations, University of Vaasa, Vaasa, Finland

⁴ Portucalense University Infante D. Henrique (UPT), R. Dr. António Bernardino de Almeida, 541, Porto Portugal

Emails: mv.ghavidel@fe.up.pt (M.V-G.), ss.ja85@yahoo.com (S.J), mattgough23@gmail.com (M.G), msjavadi@gmail.com (M.S.J.), sdfsantos@gmail.com (S.F.S.), miadreza@gmail.com (M.S-K.), catalao@fe.up.pt (J.P.S.C.)

Abstract

Energy storage is an important element of an energy system. In the power system, energy storage can be defined as components that can be employed to generate a form of energy or utilize previously stored energy at different locations or times when it is required. Energy storage can enhance the stability of the grid, increase the reliability and efficiency of integrated systems that include renewable energy resources and can also reduce emissions. A diverse set of storage technologies are currently utilized for the energy storage systems (ESSs) in a varied set of projects. This chapter provides information about the current ESS projects around the world and emphasizes the leading countries which are developing the applications of the ESSs. The main categories of ESSs are explained in this chapter as follows: electrochemical, electromechanical, electromagnetic, and thermal storage. Moreover, the energy storage technologies are utilized in power grids for various reasons such as electricity supply capacity, electric energy time-shifting, on-site power, electric supply reserve capacity, frequency regulation, voltage support, and electricity bill management. Additionally, by integrating the various energy forms and developing the concept of multi-energy systems, ESS become a fundamental component for the efficient operation of multi-energy systems. The main role of ESSs in multi-energy systems is to compensate for the fluctuations in power output from renewable energy resources. Moreover, the performance of the multi-energy system increases when it got integrated with an ESS. In this chapter, the applied ESS technologies in the context of the multi-energy systems are presented and explained.

Keywords: Electrochemical, Electromechanical, Energy storage technologies, Multi-energy systems, Power systems.

I. List of Abbreviations

ESS	Energy storage system
CAES	Compressed air energy storage
PHS	Pumped hydroelectric storage
SMES	Superconducting magnetic energy storage
BESS	Battery Energy Storage Systems
TES	Thermal energy storage

II. Introduction

Energy storage systems (ESSs) play an essential role in multi-energy systems. These storage systems not only allow for the balancing between fluctuations in energy supply and demand but can also offer important means to convert energy from one form to another. This ability of energy storage systems to store energy across time, location and energy type greatly increases the flexibility of the integrated energy systems [1]. This chapter provides a comprehensive overview of energy storage technologies being applied to multi-energy system and show how these emerging technologies and systems play a critical role in any future energy system. Expectations are that needs for energy storage systems will triple by 2030 [1].

As the energy system evolves into one dominated by intermittent renewable energy sources, energy storage systems have experienced a massive increase in research and development from both academic and commercial developers [2]. This has led to immense reductions in cost and improvements in system efficiency and this is expected to continue in the near-term future. Despite these improvements, there still needs to be further development in this sector. This can be done through a combination of deployment led innovation and active policies and regulation which shape research and development [3].

The breadth of energy storage applications is rapidly accelerating and is shown in the emerging sector of hybrid or multi-energy systems energy systems. These are systems that combine a various renewable

energy, traditional energy sources and storage systems which complement each other to develop energy systems that take advantages of each of the component systems [2].

Within multi-energy systems, energy storage technologies can be applied at nearly all scales and timeframes [4]. Each of the different energy storage technologies have their own advantages and disadvantages and the exact combination of technologies for a given application should be carefully studied to ensure that the full potential of energy storage systems in multi-energy systems is harnessed [5].

This chapter introduces the concept of energy storage and discusses the various types of energy storage systems. Recent projects using energy storage systems are highlighted to show the diversity of applications of energy storage systems. Then the concept of multi-energy systems is discussed briefly, with a detailed focus on the application of energy storage technologies to multi-energy systems.

III. Energy storage

In the energy system, an important component is energy storage. Within the power system, the energy storage can be defined as a component that can be employed to generate a form of energy or storing energy for use at a different time or location.

A. The main concept of energy storage in the power system

Applications of renewable energy resources around the world have developed and increased exponentially due to their advantages over traditional energy resources such as power plants that use fossil fuels. Despite these advantages, the fast growth of renewable energy resources has brought some challenges to the power system as well. One of the main issues of the renewable energy resources is the intermittent generation which is dependent on many factors such as solar irradiation, wind speed and direction among others [6], [7]. These factors lead to fluctuations in electricity generation from renewable energy resources. Utilization of ESSs can address this issue and play a complementary role for renewable energy resources in order to create a reliable and sustainable energy system.

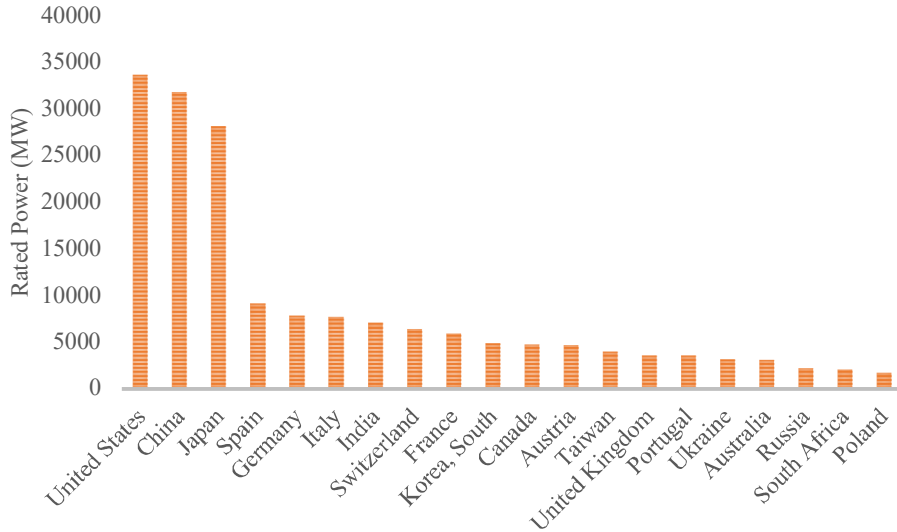

Fig. 1: Top countries in ESS capacities [8]

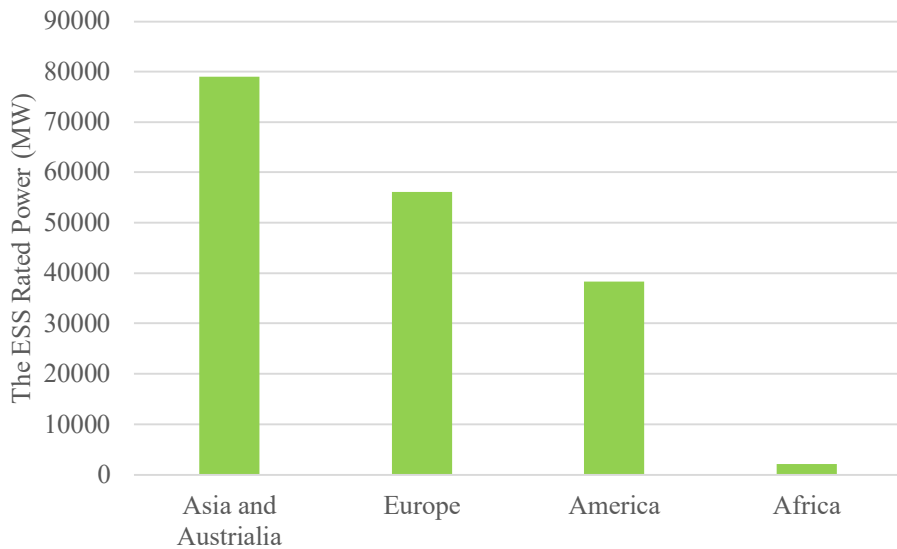

Fig. 2. The cumulative capacity of ESS of each continent [8]

The top countries in terms of installed ESS projects or those to be built, are shown in Fig. 1. The total capacity of ESS that these 20 countries is approximately 175.45 GW [8]. According to this figure, the US is the country with the highest capacity of ESS. The US has around 33.5 GW of ESS capacity [8],[9]. China and Japan are at the second and third places with 31.7 GW and 28.1 GW of capacity, respectively. If we take a deeper look at Fig. 1, there is a major difference in capacities of these three countries relative to the remaining 17 countries. For instance, Germany’s ESS capacity is 7.8 GW which is around four times lower than the ESS capacity of the US. This can indicate that ESSs are considered as an important component of the energy system in the US, China and Japan. Where the dimensions of Germany and Japan are almost same, however, the ESS capacity of Japan is much greater than Germany. However, the observed data shows that the dimensions of the country have a positive relation on the ESS capacity on

most of the cases. Another important observation from Fig. 1 is related to the share of ESSs in each continent. For instance, in Asia and Australia, considering China, Japan, India, South Korea, Taiwan and Australia, the ESS share is equal to 79 GW. In European countries, this figure is 56 GW of ESS capacity which includes Spain, Germany, Italy, Switzerland, France, Austria, United Kingdom, Portugal, Ukraine, Russia, and Poland. North America has 38.3 GW of capacity that includes the US and Canada. Finally, South Africa is the only country from Africa that is listed in the top 20 countries with an ESS capacity of 2 GW. Therefore, Asia and Australia are the leading followed by Europe and then North America. This number of the ESS capacity for Europe indicates that if the energy network of European countries is connected together, their real ESS capacity is higher than the three top countries in the list.

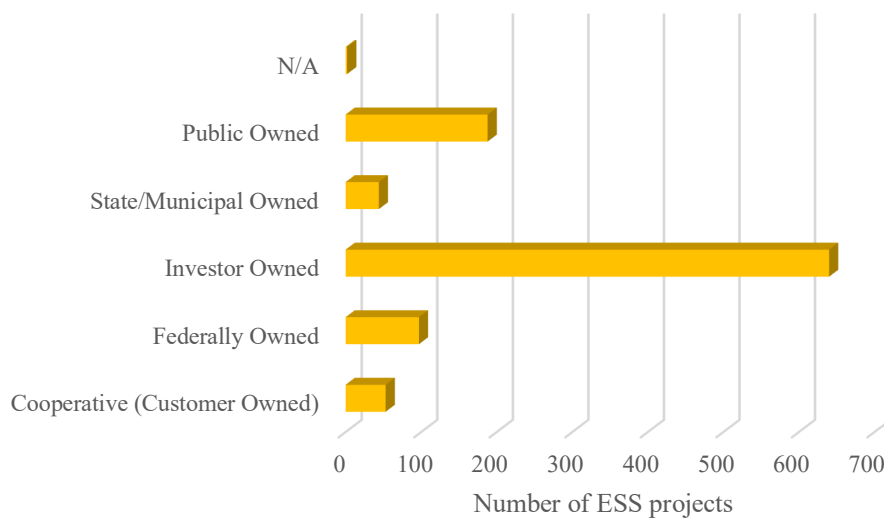

Fig. 3. Type of the ESS ownership [8]

The ownership type of the current ESS projects is given in Fig. 3. As shown in this figure, there are five main categories of ESS ownership. Most of the ESS projects are Investor-Owned projects which means that they belong to the investment companies that are developing the project. There are 640 projects that are being implemented and managed by their investors. Public-Owned ESS projects are in second place and then, Federally-Owned and State/Municipal-Owned are next. 188 projects are considered to be Publicly-Owned projects and there are 53 projects which are owned by Cooperatives. In Fig. 3, there are two projects fall outside of the above-mentioned categories. In other words, their ownership is not belonged to the public, state, investor or other above-mentioned categories.

B. Different types of energy storage systems

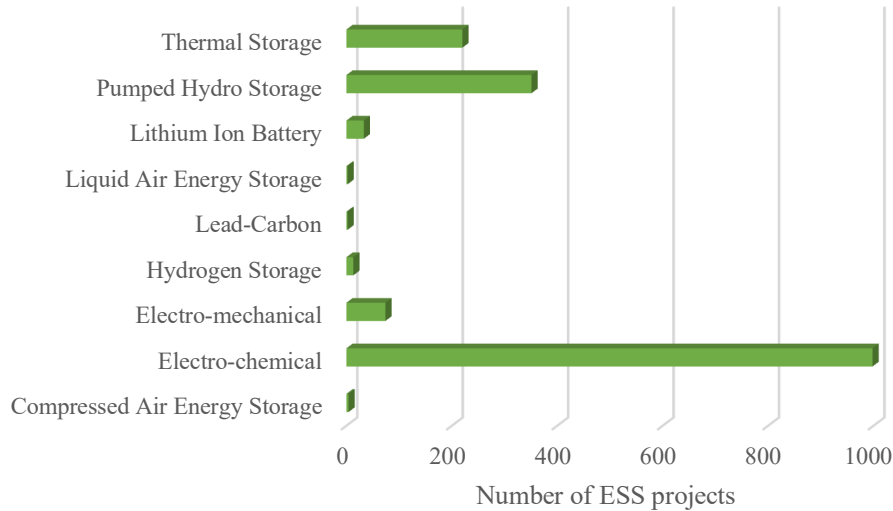

Fig 4. The various ESS technologies [8]

Many different technologies are being utilized for current ESS projects. The classification of these technologies is dependent on many factors such as the purpose of energy storage. For instance, they can be classified according to their operation duration, or type of function [10], [11]. Electrical and thermal are the main types of energy that are being stored. The different energy storage technologies are listed in Fig. 4. In this list, the main storage systems are as follows: mechanical storage, pumped hydro storage, lithium-ion battery, liquid air energy storage, lead-carbon, hydrogen storage, electromechanical, electrochemical, and thermal storage systems [12]–[19]. According to the information provided in the literature, electrochemical energy storage systems are the most popular and common storage technology [10]. There are currently at least 998 project around the world that are categorized as electrochemical energy storage systems [8]. Pumped hydro storage technology is another common type and there are more than 350 projects which employ pumped hydro storage technology. There are 220 projects using thermal storage technology according to the information shown in Fig. 4. However, there are some technologies which are less common and popular for companies which are designing and implementing energy storage technologies for the energy network. These less-common technologies are liquid air energy storage and lead-carbon technologies [15], [16].

Table 1: The rated power of each ESS technology

ESS Technology	Rated Power (GW)
Electrochemical storage	118.2
Compressed Air Energy Storage	1.6
Electromechanical	4.5
Hydrogen Storage	1.3
Lead-carbon	0.02
Liquid Air Energy Storage	0.33
Lithium-Ion Battery	1.7
Pumped Hydro Storage	51.8
Thermal Storage	12.5

Based on a report from the US Department of Energy, the global capacity of energy storage systems is equal to 191.2 GW in 2020 and this is a 12% increase comparing to 2017 [20]. Table 1 shows the cumulative capacity of energy storage systems for each type of energy storage technology. According to this table, electrochemical systems have the greatest capacity of rated power among all currently available storage technologies at 118.2 GW. Lithium-ion batteries are also becoming an important source of energy storage due to their application in the electric vehicles section.

Then, the pumped hydro storage with 51.8 GW captures the second greatest cumulative rated power capacity. The lithium-ion battery is also becoming an important source of energy storage due to its application in the electric vehicles sector [21]. Next in terms of installed capacity, there is pumped hydro storage with 51.8 GW of rated power capacity.

It should be noted that in this chapter, energy storage systems are classified into four main categories which are electrochemical energy storage, electromechanical energy storage, electromagnetic energy storage, and thermal energy storage as depicted in Fig. 5. Each category will be introduced and explained in the next sections.

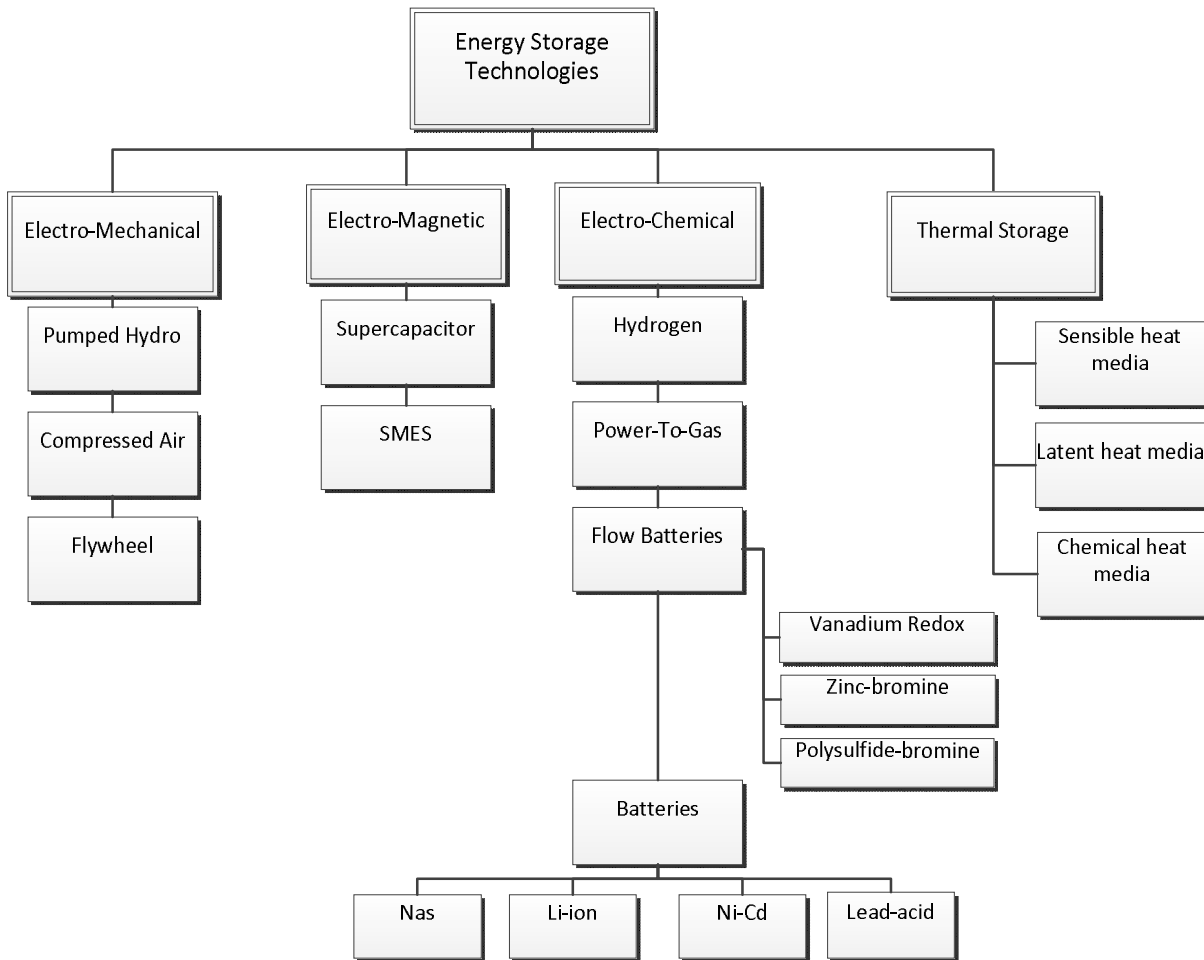

Fig. 5. The main classification of energy storage systems [22]

1) Electromechanical energy storage systems

The most established ESS in high power application is Pumped hydroelectric storage (PHS) which has been used since the 1890s. PHS is a sustainable energy source, with the flexibility and storage capacity to improve grid stability [23]. PHS is operated in low demand periods, extra energy is used from the grid to pump water from a lower to an upper reservoir. Low-cost surplus off-peak electric power is normally used to run the pump. In high demand periods, the opposite occurs with water flowing from the upper reservoir to the lower one and turning a turbine to generate electricity to export to the grid. The gravitational potential energy of the stored water determines the energy storage potential [22]. PHS allows energy from renewable sources like solar and wind, or excess electricity from sources like coal or nuclear, to be saved for periods of higher demand. PHS is a suitable technology for small autonomous island grids and large-scale energy storage. The energy efficiency of PHS is approximately 70 to 80% [23].

Another type of mechanical energy storage is compressed air energy storage (CAES). It also has a relatively simple operating principle. Air is compressed by an electrical compressor and this compressed

air can be stored in suitable storage vessels. In fact, electrical energy is changed to potential energy of compressed air. An air turbine expands the air and it releases back the energy to the grid [24]. In comparison with other energy storage systems, CAES has a large storage capacity, low self-discharge and a long lifetime [25]. These characteristics make CAES very suitable and cost-effective for bulk energy storage systems. In advanced CAES projects, the efficiency has been improved (around 70%–80% efficiency) [26]. A vast amount of compressed air can be stored underground so, CAES can provide a large amount of the world's future energy storage demands [25].

Another common type of electro-mechanical storage technology are flywheels [27]. Flywheels consist of a massive rotating cylinder, attached to a shaft, which is supported on a stator. The cylinder rotates and stores kinetic energy. The flywheel is connected to a motor-generator that interacts with the grid through advanced power electronics. When the system is utilized as a motor and a generator, it is being charged and discharged, respectively. Nowadays, some magnetic bearings are used in order to decrease friction and shear. To maintain efficiency, the flywheel system is operated in a vacuum to reduce drag.

Low maintenance, long lifetimes and low environmental impacts are some of the advantages of flywheel energy storage systems. Flywheels are more applicable to short-term storage systems as the self-discharge rate is nearly 20% of the hourly stored energy [22]. Flywheel energy storage systems are good choices for various applications in power systems such as power quality improvements, power smoothing, renewable energy integration support and stability improvements [28].

2) Electromagnetic energy storage systems

One of the systems used to store the energy electromagnetically is supercapacitor. It is made from electrochemical cells containing two electrodes, an electrolyte and a membrane. The porous membrane provides an area for the ions to transfer between the electrodes. No chemical reaction occurs in supercapacitors in contrast to what happens in batteries. Supercapacitors store the energy in the cells electrostatically. The anode contains negative charges, the cathode contains positive charges, and the electrolyte contains both. By applying a voltage to the electrodes, an electrical double layer forms in the vicinity of the anode and cathode. In fact, the electric field created by these double layers is where the energy is stored [22].

Because of the fast charge/discharge and high-power density, supercapacitors are applicable as supplementary energy sources in electric vehicles, consumer electronics and industrial fields. However, due to their fast self-discharge and low energy densities, supercapacitors are not suitable as primary power sources [29]. To overcome the issues, some improvements are needed in configuration, electrode material and electrolyte.

Another system for storing energy in a magnetic field is superconducting magnetic energy storage (SMES). SMES system stores energy in a magnetic field. This magnetic field is generated by a DC current traveling through a superconducting coil [30]. The wire is made of a superconducting material that is cryogenically kept cold so the electric current passes through the coil with almost zero resistance. This allows the energy to be stored in the system for a longer period. Normally the superconducting material can be mercury, vanadium, and niobium-titanium. To discharge the stored energy in an SMES, the conductive coil is connected to an AC power convertor. SMES systems are very efficient storage systems (around 90 % efficiency), but they have very low energy densities and they are still far from being economically lasting [30], [31].

3) Electrochemical energy storage systems

Hydrogen energy storage is a form of electrochemical energy storage in which electrical power is converted into hydrogen by an electrolyzer [32]. Later, this stored energy can be released by using the gas as fuel in a combustion engine or a fuel cell [33]. Electrolysis of water is a simple process to produce hydrogen. The efficiency of water electrolysis depends on the technology, the hydrogen production rate and the pressure level [22]. Most commonly, hydrogen is stored as a compressed gas in a container. Also, it can be stored in very low temperature as a cryogenic liquid. Some other methods like metal hydride materials or chemical hydrides can be used to store hydrogen. In this method, the hydrogen is bonded to a material and it can be released as required. Hydrogen can be utilized as fuel in a gas turbine, piston engines and hydrogen fuel cells. Hydrogen energy storage systems can provide much longer duration storage compared to batteries [33].

Battery Energy Storage Systems (BESS) are a family of technologies developed for storing electric charge by using batteries. In most of the energy storage systems with batteries, electrical energy is converted into chemical energy and vice versa. Redox, reduction and oxidation reactions occur in the battery cell. Each battery consists of two electrodes, electrolyte, a separator and a container. The electrolyte is a material in which the ions can be transferred between anode and cathode, and the redox reaction can take place. This electrolyte is an electronic insulation material. The separator prevents internal short circuits of the battery from occurring and the container is needed to enclose and to protect the battery cell [22].

Battery energy storage systems have the advantages of small footprint and no restrictions on geographical locations where they could be located. Other storage technologies such as PHS and CAES are only suitable for limited number of locations. For instance, topological conditions, long development time and large land use are the main constraints in development of PHS projects [34]. Batteries are of various types such as Lithium-ion, Lead-acid, Sodium Sulfur, Zinc bromine and Flow.

4) Thermal energy storage systems

Another form of energy storage is thermal energy storage (TES). In thermal energy storage systems, thermal energy is stored by heating or cooling a storage medium [35], [36]. The stored energy can be released later for power generation and other demands where it can generate steam for electricity production [3]. In this storage system, different materials with different thermal properties can be used and various results can be achieved. TES systems are commonly used in buildings and in industrial processes. Solar thermal systems are the most common application in TES systems. There should be a heat sensitive material in a solar power plant like molten salt. The solar field gathers the energy from the sun and heats up the molten salt. A heat transfer fluid is heated up by the hot salt through heat exchanger and then a turbine (connected to a generator) is spun using this fluid. Even if there is no sun, the turbine can be run with the heat stored in the molten salt [22].

C. Advantages of storage in the energy system

The energy storage technologies are employed in power grids for various reasons [37]–[39]. The most common advantage of the application of energy storage systems are given in Table 2. In this table, the various services that the storage technologies are being used for are listed in the first column. In the first row, the different storage technologies are given. Different services for the storage are electric supply capacity, electric energy time-shift, on-site power, electric supply reserve capacity, frequency regulation, voltage support, and electricity bill management. According to this table, it is shown that electrochemical energy storage is broadly employed for electric energy time shift, frequency regulation, and renewable capacity firming. For example, there are 267 projects that are employed the electrochemical energy storage system for electric energy time shift service. There are also 225 electrochemical energy storage systems that are designed or operating for the purpose of frequency regulation.

Furthermore, through analysis of Table 2, it can be seen that electric energy time shift service is the only service that uses all types of energy storage technologies. Besides that, electrochemical storage is also being used for all of the power grid services. As there are no services that do not use the electrochemical type of energy storage. The electrochemical energy storage with 998 projects worldwide is the most popular storage technology that used to supply one of the services to power grids.

Table 2: The Energy Storage Systems Projects based on their storage type and services [8]

	Electroche mical	Electrom echanical	Thermal Storage	Hydrogen Storage	Lead- Carbon	Liquid Air Energy Storage	Lithium- Ion Battery	Pumped Hydro Storage	Compressed Air Energy Storage
Electric Supply Capacity	100	4	0	1	0	0	0	302	2

Electric Energy Time Shift	267	16	84	1	2	1	1	325	3
On-Site Power	121	5	1	0	0	0	27	1	0
Electric Supply Reserve Capacity - Spinning	63	22	3	0	0	0	0	83	1
Frequency Regulation	225	34	6	3	0	1	1	66	0
Voltage Support	157	18	1	0	0	1	1	37	1
Load Following (Tertiary Balancing)	62	4	0	2	0	0	0	27	0
Black Start	51	2	0	0	0	0	0	15	0
Electric Bill Management with Renewables	105	3	2	1	0	0	3	1	0
Stationary Transmission/Distribution Upgrade Deferral	44	0	4	1	0	0	0	0	0
Transmission Support	27	1	3	0	0	1	0	2	0
Renewables Capacity Firming	278	11	55	8	0	0	1	15	3
Renewables Energy Time Shift	202	17	62	6	0	0	28	18	3
Grid-connected commercial (reliability and quality)	81	4	3	0	0	0	2	2	0
Transportation services	51	1	0	2	0	0	0	0	0
Distribution upgrade due to solar Ramping	48	0	0	0	0	0	0	0	0
Grid-connected residential (reliability)	54	4	1	1	0	0	0	5	0
Microgrid capability	47	0	3	0	0	0	1	0	0
Transmission congestion relief	170	9	1	0	0	0	26	0	0
Transmission support	20	1	3	1	0	1	0	3	0
Transmission support	27	1	3	0	0	1	0	2	0

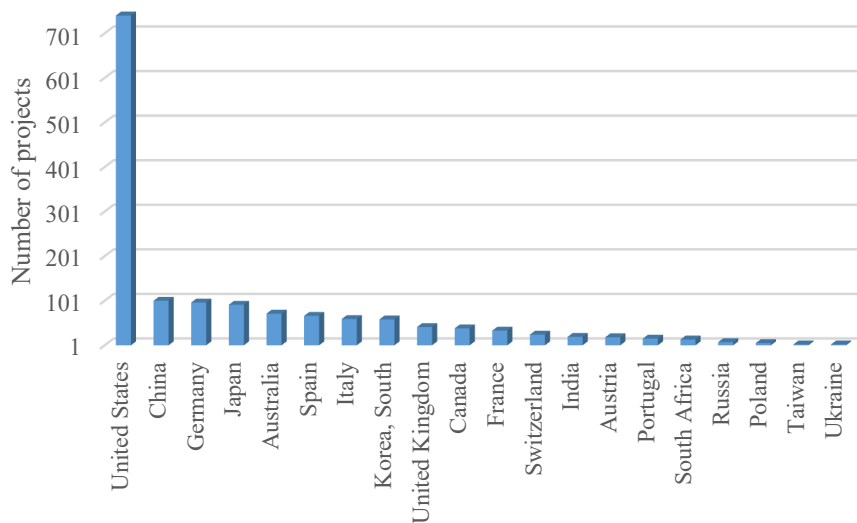

Fig. 6. Number of the ESS projects in the top countries [8]

According to data published by the US Department of Energy [8], there are 1698 projects that are based on the development of the ESSs until 2020. Thus, the number of the ESS projects in the top countries regarding implementation of this technology is depicted in Fig. 6. As illustrated in this figure, US by working on more than 740 projects is the world's lead country in this regard. China and Germany are in the next places by running 101 and 97 ESS projects, respectively. However, all of the projects are not in the operational phase. In order to present a better view regarding the applied ESS projects around the world, Fig. 7. is representing the current situation of the total ESS applications around the world. This figure indicates that there are 1363 projects out of 1698 which their design and construction is done and they are in the operational mode. This number is equal to almost 80 percent of all of the currently published ESS projects. 180 projects are also in the announcing phase and from this number there are 9 ESS which were announced but they were never built. More details about the current situations of the ESS programs can be followed in Fig. 7.

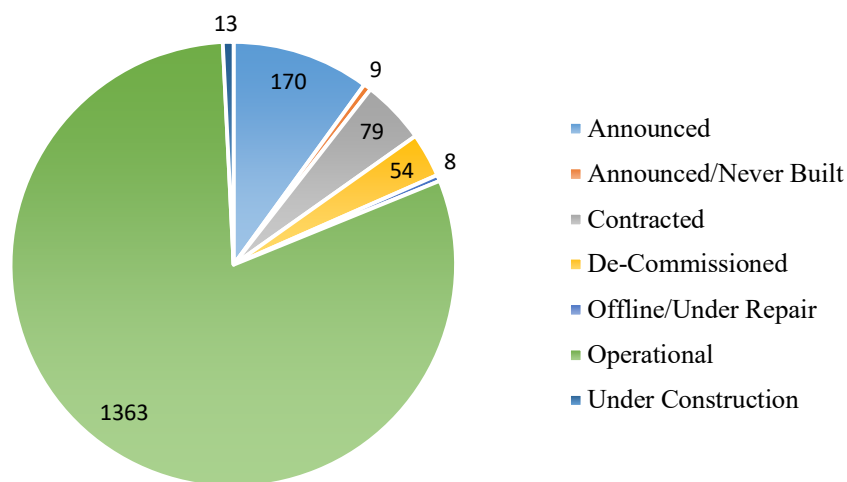

Fig. 7. The current situation of the total ESS applications around the world [8]

IV. Energy storage technologies application in the multi-energy systems

The significance of energy storage systems in the power grid has been explained and discussed in the previous sections. ESS are expected to become more significant in future energy systems, especially in multi-energy systems [40].

The different forms of energy storage such as electrical and thermal are being combined in multi-energy systems. These multi-energy systems include several energy resources, including diesel engines, gas turbines, or renewable energy resource such as wind turbines, photovoltaics, etc. For optimal operation of multi-energy systems in the presence of various energy resources, the utilization of the energy storage system is one of the most important factors [41]. The energy storage can be installed in the several points of the multi-energy system. It is common to install the storage in the output sector of the energy hub. Energy hub is defined as a place that the integration and management of several energy components such as production, conversion, storage, and consumption of different energy carriers in the multi-energy systems occurs [42]. While installment of the storage in the input side of it is also proposed in some cases. Thus, hydrogen and electrical storage can be installed in both sides of the hub, i.e., input side or output side. However, the thermal storage is usually employed in the output side of the hub. The usual structure of the multi-energy system in the presence of ESS is depicted in Fig. 8. In Fig. 8. (a)., a simple energy-hub is drawn based on the definition which was provided in [43]. According to the concept of energy hub in this study, any structure that correlates the generation and the consumption sides through transmission, conversion and ESS can be defined as an energy hub. In Fig. 8. (b). more comprehensive structure of the multi-energy system is presented where demand can be supplied through electrical, cooling and heating forms of energy.

The impact of storage size and forecasting period in the optimal operation of the multi-energy systems has been studied in [44]. This study proves that there is a reverse relation between the size of the energy storage system and operational cost of the multi-energy system. In other words, larger energy storage will lead to a lower cost in the multi-energy system. However, the impact of the size of the energy storage is lower than the length of the forecasting horizon. Long forecasting horizon for the energy storage can lead to a reduction in the costs of the energy hub. Moreover, Ivalin Petkov *et al.* proved that the application of ESS has the capability to reduce emissions by 90% in multi-energy systems which include

renewable energy resources [45]. To better highlight the advantages of ESS in multi-energy systems, several applications of the energy storage systems are summarized in the following part of this section.

With the aim of optimization of the total operation cost of the energy hub and to consider the uncertainty posed from the distribution system including electricity, heating and cooling loads, a power to gas storage with tri-state compressed air energy storage system is proposed in [46]. Authors in [45] implemented a conditional value-at-risk approach for managing the uncertainties originating from wind power generation, electrical and thermal loads in a multi-energy system which utilizes a compressed air energy storage system in order to decrease the fluctuations caused by the renewable energy resources as well as increase the freedom of the multi-energy system's operator. An underground hydrogen storage system is proposed in [47] in order to minimize the CO₂ emissions in the context of an integrated energy system by developing a mixed-integer linear program optimization model which focuses on the dynamics of the stored energy during the hydrogen injection and withdraw processes.

The ESS is also a complementary component in the multi-energy systems for the demand response programs [48]. Since the goal of the operator from employment of the demand response programs is to meet the amount of the generation with the required load especially during the peak period. The energy storage technology can also support this goal by providing a percentage of the demand to the consumers when there is a lack in the supplying side and it is not possible for the consumers to participate in the demand response programs. Therefore, the storage can be charged in the multi-energy systems through the acquired demand response during the off-peak period. This aggregated demand response can be discharged in the multi-energy system during the peak period to meet the consumers' demand and reduce the pressure from the generation side. For instance, the authors in [49] presented an optimal model for the operation of energy hub by utilization of renewable energy resources, demand response program and energy storage system. In order to provide more flexibility for the operation of the energy-hub, several

demand response programs for the residential sector of the consumers such as shifting program, curtailing program are proposed as a complementary component of the energy storage system in [50].

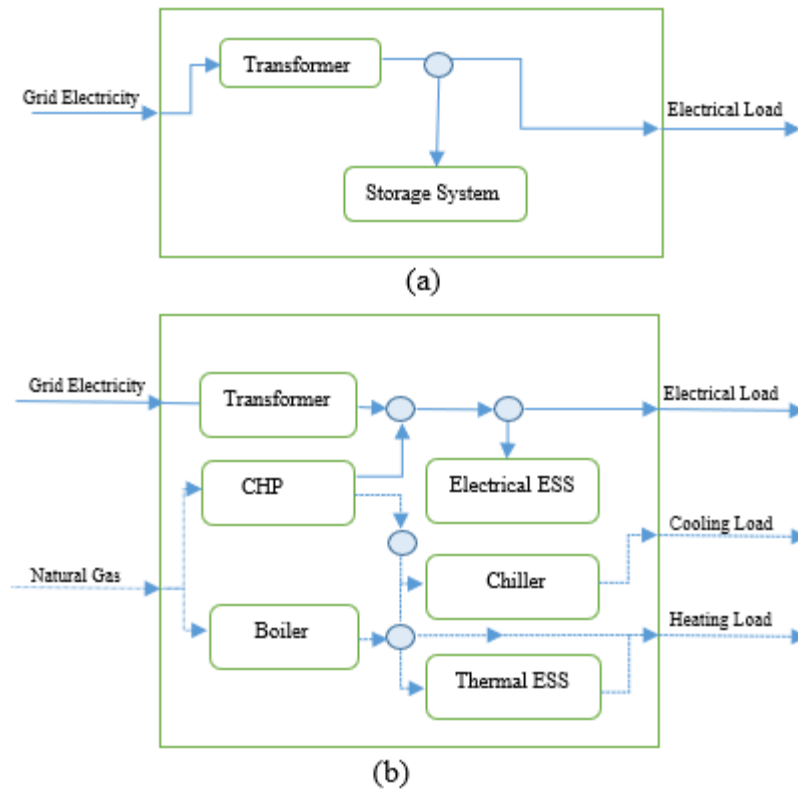

Fig. 8. Multi-energy structure in presence of ESS [42]

V. Conclusion

Energy storage is a necessary component in the energy system in order to store the generated energy to reuse whenever it is required. There are various regimes that could be defined for the status of the ESS such as the charging regime, storing regime and discharging regime. The energy storage is considered to be one of the most important components in the energy system that can be employed to generate a form of energy or use the stored energy in the moment or place that is required. The application of ESSs can lead to a grid with enhanced stability, increased reliability in the integrated systems that include renewable energy resources and improve efficiency of the energy system and reduce the environmental emissions.

Many storage technologies are being employed in current energy storage systems. The most recent information of the current ESS projects around the world has been presented in this chapter by

emphasizing the leading countries which are developing the ESS projects. The US, China and Germany are the top three countries in the world with the highest number of ESS projects.

The classification of these technologies is dependent on many factors, including the purpose of storing energy. Electrochemical, electromechanical, electromagnetic, and thermal storage are considered as the main four categories for the ESSs technologies and they are presented and explained in detail. The advantages of the energy storage technologies are presented as well. The implementation of ESS in the power system is done to meet different services. The most common services for the application of energy storage systems are discussed in detail in this chapter such as electric supply capacity, electric energy time-shift, on-site power, electric supply reserve capacity, frequency regulation, voltage support, and electricity bill management. Additionally, by integration of the various energy forms and developing the concept of the multi-energy systems, one of the key components of multi-energy systems are ESSs. The main role of the ESSs in multi-energy systems is to compensate for the fluctuations introduced by renewable energy resources. In this chapter, ESS technologies in the context of the multi-energy systems are presented and explained.

Furthermore, in the context of multi-energy system, the storage unit can be installed in both sides of the input or output of the system as hydrogen and electrical storage can be installed in both sides, while, the thermal storage usually is employed in the output side of the system. Moreover, it is shown that the ESS can also be a complementary component for the demand response actions to provide more flexibility for the operation of the energy hub especially during the high consumption periods.

References

- [1] A. Z. AL Shaqsi, K. Sopian, and A. Al-Hinai, "Review of energy storage services, applications, limitations, and benefits," *Energy Reports*, vol. 6. Elsevier Ltd, pp. 288–306, Dec. 01, 2020, doi: 10.1016/j.egy.2020.07.028.
- [2] C. A. Murphy, A. Schleifer, and K. Eurek, "A taxonomy of systems that combine utility-scale renewable energy and energy storage technologies," *Renewable and Sustainable Energy Reviews*, vol. 139. Elsevier Ltd, p. 110711, Apr. 01, 2021, doi: 10.1016/j.rser.2021.110711.
- [3] I. Sarbu and C. Sebarchievici, "A comprehensive review of thermal energy storage," *Sustainability*, vol. 10, no. 1, p. 191, 2018.
- [4] C. S. Lai, G. Locatelli, A. Pimm, X. Wu, and L. L. Lai, "A review on long-term electrical power system modeling with energy storage," *Journal of Cleaner Production*, vol. 280. Elsevier Ltd, p. 124298, Jan. 20, 2021, doi: 10.1016/j.jclepro.2020.124298.
- [5] S. B. Sani *et al.*, "Energy storage system policies: Way forward and opportunities for emerging economies," *Journal of Energy Storage*, vol. 32. Elsevier Ltd, p. 101902, Dec. 01, 2020, doi: 10.1016/j.est.2020.101902.
- [6] H. Lund, "Renewable energy strategies for sustainable development," *Energy*, vol. 32, no. 6, pp. 912–919, Jun. 2007, doi: 10.1016/j.energy.2006.10.017.

- [7] P. A. Østergaard, R. M. Johannsen, and N. Duic, "Sustainable development using renewable energy systems," *Int. J. Sustain. Energy Plan. Manag.*, vol. 29, pp. 1–6, Sep. 2020, doi: 10.5278/ijsepm.4302.
- [8] "Global Energy Storage Database | Energy Storage Systems." <https://www.sandia.gov/ess-ssl/global-energy-storage-database/> (accessed Apr. 05, 2021).
- [9] S. Koochi-Fayegh and M. A. Rosen, "A review of energy storage types, applications and recent developments," *Journal of Energy Storage*, vol. 27. Elsevier Ltd, p. 101047, Feb. 01, 2020, doi: 10.1016/j.est.2019.101047.
- [10] X. Luo, J. Wang, M. Dooner, and J. Clarke, "Overview of current development in electrical energy storage technologies and the application potential in power system operation," *Appl. Energy*, vol. 137, pp. 511–536, Jan. 2015, doi: 10.1016/j.apenergy.2014.09.081.
- [11] S. Ghosh and S. Kamalasan, "An Energy Function-Based Optimal Control Strategy for Output Stabilization of Integrated DFIG-Flywheel Energy Storage System," *IEEE Trans. Smart Grid*, vol. 8, no. 4, pp. 1922–1931, Jul. 2017, doi: 10.1109/TSG.2015.2510866.
- [12] M. Mahmoud, M. Ramadan, A. G. Olabi, K. Pullen, and S. Naher, "A review of mechanical energy storage systems combined with wind and solar applications," *Energy Conversion and Management*, vol. 210. Elsevier Ltd, p. 112670, Apr. 15, 2020, doi: 10.1016/j.enconman.2020.112670.
- [13] E. Barbour, I. A. G. Wilson, J. Radcliffe, Y. Ding, and Y. Li, "A review of pumped hydro energy storage development in significant international electricity markets," *Renewable and Sustainable Energy Reviews*, vol. 61. Elsevier Ltd, pp. 421–432, Aug. 01, 2016, doi: 10.1016/j.rser.2016.04.019.
- [14] G. Zubi, R. Dufo-López, M. Carvalho, and G. Pasaoglu, "The lithium-ion battery: State of the art and future perspectives," *Renewable and Sustainable Energy Reviews*, vol. 89. Elsevier Ltd, pp. 292–308, Jun. 01, 2018, doi: 10.1016/j.rser.2018.03.002.
- [15] M. Antonelli, S. Barsali, U. Desideri, R. Giglioli, F. Paganucci, and G. Pasini, "Liquid air energy storage: Potential and challenges of hybrid power plants," *Appl. Energy*, vol. 194, pp. 522–529, May 2017, doi: 10.1016/j.apenergy.2016.11.091.
- [16] W. L. Zhang *et al.*, "Lead-carbon electrode designed for renewable energy storage with superior performance in partial state of charge operation," *J. Power Sources*, vol. 342, pp. 183–191, Feb. 2017, doi: 10.1016/j.jpowsour.2016.12.061.
- [17] F. Zhang, P. Zhao, M. Niu, and J. Maddy, "The survey of key technologies in hydrogen energy storage," *International Journal of Hydrogen Energy*, vol. 41, no. 33. Elsevier Ltd, pp. 14535–14552, Sep. 07, 2016, doi: 10.1016/j.ijhydene.2016.05.293.
- [18] W. Yan, X. Wang, W. Gao, and V. Gevorgian, "Electro-mechanical modeling of wind turbine and energy storage systems with enhanced inertial response," *J. Mod. Power Syst. Clean Energy*, vol. 8, no. 5, pp. 820–830, Sep. 2020, doi: 10.35833/MPCE.2020.000272.
- [19] J. B. Goodenough, "Electrochemical energy storage in a sustainable modern society," *Energy and Environmental Science*, vol. 7, no. 1. Royal Society of Chemistry, pp. 14–18, Dec. 11, 2014, doi: 10.1039/c3ee42613k.
- [20] M. M. Rahman, A. O. Oni, E. Gemechu, and A. Kumar, "Assessment of energy storage technologies: A review," *Energy Conversion and Management*, vol. 223. Elsevier Ltd, p. 113295, Nov. 01, 2020, doi: 10.1016/j.enconman.2020.113295.
- [21] H. Fathabadi, "Combining a proton exchange membrane fuel cell (PEMFC) stack with a Li-ion battery to supply the power needs of a hybrid electric vehicle," *Renew. Energy*, vol. 130, pp. 714–724, Jan. 2019, doi: 10.1016/j.renene.2018.06.104.
- [22] P. T. Moseley and J. Garche, *Electrochemical energy storage for renewable sources and grid balancing*. Newnes, 2014.

- [23] S. Rehman, L. M. Al-Hadhrami, and M. M. Alam, "Pumped hydro energy storage system: A technological review," *Renewable and Sustainable Energy Reviews*, vol. 44. Elsevier Ltd, pp. 586–598, Apr. 01, 2015, doi: 10.1016/j.rser.2014.12.040.
- [24] M. Budt, D. Wolf, R. Span, and J. Yan, "A review on compressed air energy storage: Basic principles, past milestones and recent developments," *Applied Energy*, vol. 170. Elsevier Ltd, pp. 250–268, May 15, 2016, doi: 10.1016/j.apenergy.2016.02.108.
- [25] M. Dooner and J. Wang, "Compressed-air energy storage," in *Future Energy: Improved, Sustainable and Clean Options for Our Planet*, Elsevier, 2020, pp. 279–312.
- [26] S. Koochi-Kamali, V. V. Tyagi, N. A. Rahim, N. L. Panwar, and H. Mokhlis, "Emergence of energy storage technologies as the solution for reliable operation of smart power systems: A review," *Renew. Sustain. Energy Rev.*, vol. 25, pp. 135–165, Sep. 2013, doi: 10.1016/J.RSER.2013.03.056.
- [27] A. G. Olabi, T. Wilberforce, M. A. Abdelkareem, and M. Ramadan, "Critical Review of Flywheel Energy Storage System," *Energies*, vol. 14, no. 8, p. 2159, 2021.
- [28] A. A. K. Arani, H. Karami, G. B. Gharehpetian, and M. S. A. Hejazi, "Review of Flywheel Energy Storage Systems structures and applications in power systems and microgrids," *Renewable and Sustainable Energy Reviews*, vol. 69. Elsevier Ltd, pp. 9–18, Mar. 01, 2017, doi: 10.1016/j.rser.2016.11.166.
- [29] I. Dincer, *Comprehensive energy systems*. Elsevier, 2018.
- [30] P. J. Hall and E. J. Bain, "Energy-storage technologies and electricity generation," *Energy Policy*, vol. 36, no. 12, pp. 4352–4355, Dec. 2008, doi: 10.1016/j.enpol.2008.09.037.
- [31] M. Semadeni, "Storage of Energy, Overview," *Encycl. Energy*, pp. 719–738, Jan. 2004, doi: 10.1016/B0-12-176480-X/00104-2.
- [32] P. Breeze, *Power system energy storage technologies*. Academic Press, 2018.
- [33] K. Agbossou, M. Kolhe, J. Hamelin, and T. K. Bose, "Performance of a stand-alone renewable energy system based on energy storage as hydrogen," *IEEE Trans. Energy Convers.*, vol. 19, no. 3, pp. 633–640, Sep. 2004, doi: 10.1109/TEC.2004.827719.
- [34] H. A. Behabtu *et al.*, "A Review of Energy Storage Technologies' Application Potentials in Renewable Energy Sources Grid Integration," *Sustain. 2020, Vol. 12, Page 10511*, vol. 12, no. 24, p. 10511, Dec. 2020, doi: 10.3390/SU122410511.
- [35] D. Aydin, S. P. Casey, and S. Riffat, "The latest advancements on thermochemical heat storage systems," *Renewable and Sustainable Energy Reviews*, vol. 41. Elsevier Ltd, pp. 356–367, Jan. 01, 2015, doi: 10.1016/j.rser.2014.08.054.
- [36] X. Song, T. Zhu, L. Liu, and Z. Cao, "Study on optimal ice storage capacity of ice thermal storage system and its influence factors," *Energy Convers. Manag.*, vol. 164, pp. 288–300, May 2018, doi: 10.1016/j.enconman.2018.03.007.
- [37] D. Zhang, J. Li, and D. Hui, "Coordinated control for voltage regulation of distribution network voltage regulation by distributed energy storage systems," *Prot. Control Mod. Power Syst.*, vol. 3, no. 1, pp. 1–8, Dec. 2018, doi: 10.1186/s41601-018-0077-1.
- [38] D. I. Stroe, V. Knap, M. Swierczynski, A. I. Stroe, and R. Teodorescu, "Operation of a grid-connected lithium-ion battery energy storage system for primary frequency regulation: A battery lifetime perspective," *IEEE Trans. Ind. Appl.*, vol. 53, no. 1, pp. 430–438, Jan. 2017, doi: 10.1109/TIA.2016.2616319.
- [39] D. Parra, M. Gillott, S. A. Norman, and G. S. Walker, "Optimum community energy storage system for PV energy time-shift," *Appl. Energy*, vol. 137, pp. 576–587, Jan. 2015, doi: 10.1016/j.apenergy.2014.08.060.
- [40] P. Gabrielli, F. Furer, G. Mavromatidis, and M. Mazzotti, "Robust and optimal design of multi-energy systems with

- seasonal storage through uncertainty analysis,” *Appl. Energy*, vol. 238, pp. 1192–1210, Mar. 2019, doi: 10.1016/j.apenergy.2019.01.064.
- [41] P. Simeoni, G. Nardin, and G. Ciotti, “Planning and design of sustainable smart multi energy systems. The case of a food industrial district in Italy,” *Energy*, vol. 163, pp. 443–456, Nov. 2018, doi: 10.1016/j.energy.2018.08.125.
- [42] M. Mohammadi, Y. Noorollahi, B. Mohammadi-ivatloo, and H. Yousefi, “Energy hub: From a model to a concept – A review,” *Renewable and Sustainable Energy Reviews*, vol. 80. Elsevier Ltd, pp. 1512–1527, Dec. 01, 2017, doi: 10.1016/j.rser.2017.07.030.
- [43] P. Favre-Perrod, M. Geidl, B. Klöckl, and G. Koepfel, “A vision of future energy networks,” in *Proceedings of the Inaugural IEEE PES 2005 Conference and Exposition in Africa*, 2005, vol. 2005, pp. 13–17, doi: 10.1109/pesaf.2005.1611778.
- [44] F. Adamek, M. Arnold, and G. Andersson, “On decisive storage parameters for minimizing energy supply costs in multicarrier energy systems,” *IEEE Trans. Sustain. Energy*, vol. 5, no. 1, pp. 102–109, Jan. 2014, doi: 10.1109/TSTE.2013.2267235.
- [45] M. Jadidbonab, E. Babaei, and B. Mohammadi-ivatloo, “CVaR-constrained scheduling strategy for smart multi carrier energy hub considering demand response and compressed air energy storage,” *Energy*, vol. 174, pp. 1238–1250, May 2019, doi: 10.1016/j.energy.2019.02.048.
- [46] M. A. Mirzaei *et al.*, “Integrated energy hub system based on power-to-gas and compressed air energy storage technologies in the presence of multiple shiftable loads,” *IET Gener. Transm. Distrib.*, vol. 14, no. 13, pp. 2510–2519, Jul. 2020, doi: 10.1049/iet-gtd.2019.1163.
- [47] P. Gabrielli, A. Poluzzi, G. J. Kramer, C. Spiers, M. Mazzotti, and M. Gazzani, “Seasonal energy storage for zero-emissions multi-energy systems via underground hydrogen storage,” *Renew. Sustain. Energy Rev.*, vol. 121, p. 109629, Apr. 2020, doi: 10.1016/j.rser.2019.109629.
- [48] M. Vahid-Ghavidel, M. Sadegh Javadi, S. F. Santos, M. Gough, M. Shafie-Khah, and J. P. S. Catalao, “Demand response based trading framework in the presence of fuel cells using information-gap decision theory,” Sep. 2020, doi: 10.1109/SEST48500.2020.9203313.
- [49] S. Pazouki, M. R. Haghifam, and A. Moser, “Uncertainty modeling in optimal operation of energy hub in presence of wind, storage and demand response,” *Int. J. Electr. Power Energy Syst.*, vol. 61, pp. 335–345, Oct. 2014, doi: 10.1016/j.ijepes.2014.03.038.
- [50] F. Brahman, M. Honarmand, and S. Jadid, “Optimal electrical and thermal energy management of a residential energy hub, integrating demand response and energy storage system,” *Energy Build.*, vol. 90, pp. 65–75, Mar. 2015, doi: 10.1016/j.enbuild.2014.12.039.