



Vaasan yliopisto
UNIVERSITY OF VAASA

OSUVA Open
Science

This is a self-archived – parallel published version of this article in the publication archive of the University of Vaasa. It might differ from the original.

Optimal price-based and emergency demand response programs considering consumers preferences

Author(s): Dadkhah, Akbar; Bayati, Navid; Shafie-khah, Miadreza; Vandeveldel, Lieven; Catalao, Joao P.S.

Title: Optimal price-based and emergency demand response programs considering consumers preferences

Year: 2022

Version: Accepted manuscript

Copyright ©2022 Elsevier. This manuscript version is made available under the Creative Commons Attribution–NonCommercial–NoDerivatives 4.0 International (CC BY–NC–ND 4.0) license, <https://creativecommons.org/licenses/by-nc-nd/4.0/>

Please cite the original version:

Dadkhah, Akbar; Bayati, Navid; Shafie-khah, Miadreza; Vandeveldel, Lieven; Catalao, Joao P.S. (2022). Optimal price-based and emergency demand response programs considering consumers preferences. *International Journal of Electrical Power & Energy Systems* 138, 107890. <https://doi.org/10.1016/j.ijepes.2021.107890>

Optimal Price-Based and Emergency Demand Response Programs Considering Consumers Preferences

Akbar Dadkhah^a, Navid Bayati^b, Miadreza Shafie-khah^c, Lieven Vandevelde^a ao PS Catalão^d

^a*Department of Electromechanical, Systems and Metal Engineering, Ghent University, Ghent, Belgium*

^b*Department of Energy Technology, Aalborg University, Aalborg 9100, Denmark*

^c*School of Technology and Innovations, University of Vaasa, 65200 Vaasa, Finland*

^d*Faculty of Engineering of the University of Porto and INESC TEC, 4200-465 Porto, Portugal*

Abstract

This paper presents a pricing optimisation framework for energy, reserve, and load scheduling of a power system considering demand response (DR). The proposed scheduling framework is formulated as a reliability-constrained unit commitment program to minimise the power system operation costs by finding optimal electricity prices and optimal incentives while guaranteeing the reliability of the system during contingencies. Moreover, customers' attitude toward the electricity price and incentive adjustment and the effect of their preferences on load scheduling and operation of the system are investigated in various DR programs. The proposed scheme is implemented on an IEEE test system, and the scheduling process with and without DR implementation is discussed in detail by a numerical study. The proposed method helps both the system operators and customers to reliably schedule generation and consumption units and select the proper DR program according to defined prices and incentives in the case of an emergency.

Keywords: Customers behaviour, Customers comfort, Demand response, Flexibility, Reliability, Unit commitment

1. Introduction

Demand response (DR) is one of the significant ways that help the network operators to control the electrical energy consumption during emergency conditions [1, 2]. DR implementation in modern electricity grids with modified pricing methods influences the consumers' comfort and payments [3]. The economic consequence of DR is at the heart of attraction in most DR-related studies, especially in the United States and Europe. The authors have presented a bi-level model in [4] to minimise the total costs of an isolated microgrid and maximise the revenues of a storage system using a DR scheme. Mathematical optimisation models in a real energy hub considering demand response under uncertainties have been proposed in [5, 6] to minimise the operation costs. Linear and non-linear optimisation models have been proposed in [7, 8] to assess the economic feasibility of providing DR programs by hydrogen production units and their effect on power system flexibility. An experimental methodology has been introduced in [9] to identify the flexibility of customers in response to financial incentives. The authors have examined the relationships of home appliance usage, energy consumption, and participation in IBDRPs for peak load reduction in [10]. The impact of a time-of-use (TOU) program on consumption patterns of the residential consumers has been studied in [11]. Although TOU design has been employed

as a powerful approach to change customers electricity consumption, current TOU programs are not as effective as required in many developed countries due to the complexity of human behaviour. Some metrics have been used in [12] to assess the DR flexibility of heat pumps. A control algorithm for the load aggregation has been presented using an energy consumption tool. Compared to [12], it is also possible to examine the total consumption at each bus rather than modelling of the individual consumption pattern for residential loads. In this manner, DR programs let the system operator plan a proper production capacity. In [13], the influence of customers participation level in an emergency DR program (EDRP) and the effect of incorrect incentives on the microgrid performance have been studied. In the above-mentioned studies, TOU or incentive-based DR programs (IBDRPs) have been used without considering reliability standards and different types of consumers whose comfort preferences have not been examined when participating in such programs.

Apart from the economic point of view, DR programs have been also employed in several studies for enhancing the reliability of the network by considering renewable energy penetration and unforeseen events [14, 15]. In [16], a new formulation of reliability indices has been proposed considering the outages of generation units where the customers participate in both energy and reserve scheduling through DR. However, the hourly price of electricity and incentives have not been calculated. Transmission switching has been deployed in a unit commitment (UC) prob-

Email address: Akbar.Dadkhah@UGent.be (Akbar Dadkhah)

Nomenclature

Acronyms

CDI	Consumption delay index
CWI	Consumption way index
DR	Demand response
EDNS	Expected demand not served
EDRP	Emergency demand response program
FOR	Forced outage rate
IBDRP	Incentive-based demand response program
ISO	Independent system operator
LRCs	Long-range customers
MCs	Mixed customers
PBDRP	Price-based demand response program
PEM	Price elasticity matrix
PI	Payment index
RT	Real time
SCUC	Security-constrained unit commitment
TOU	Time of use
VoLL	Value of lost load

Indices

b, b'	Index of buses
c	Index of components
f	Index for segments of linearised fuel cost
g	Index of generators
i, j	Index of times
l	Index of transmission lines
s	Index of scenarios

Parameters

B	Number of buses
C	Number of components
d_{bi}^0	Baseline consumption of bus b at hour i (MW)
\overline{DR}_b	Maximum consumers' reply to DR signals at bus b
\overline{EDNS}	Maximum amount of EDNS (MW)
E_{ij}	Elasticity of demand
F	Number of segments in piece-wise linearised fuel cost
\underline{FC}_g	Minimum fuel cost of generator g (\$/h)
G	Number of generators
G_b	Number of generation units at bus b
H	Number of hours
K_g	Start-up cost of generator g (\$/MWh)

L	Number of transmission lines
\overline{M}_{fg}	Maximum production of segment f for generator g (MW)
$\overline{P}_g, \underline{P}_g$	Maximum/minimum production of generator g (MW)
\overline{P}_l	Maximum power on line l (from bus b to b') (MW)
S	Number of scenarios
T	Spinning reserve market lead time (min)
V_{bi}^{Sh}	Penalty for not-served load at bus b , hour i (\$/MWh)
$X_{bb'}$	The line reactance (from bus b to b')
α_s	Probability of scenario s
β_{fg}	Slope of segment f in cost curve of generator g (\$/MWh)
ψ	Loss-gain coefficient
ρ_{bi}^0	Baseline rate at bus b and hour i (\$/MWh)

Variables

A_{bj}	Incentive in EDRP at bus b and hour j (\$/MWh)
CP_i	Customers payment at hour i (\$)
d_{bi}	Customers' consumption at bus b and hour i (MW)
FC_{gi}	Fuel cost of generation unit g at hour i (\$)
I_{gi}	Off/On status of generator g at hour i
L_{bis}^{Sh}	Load curtailment at bus b , hour i , scenario s (MW)
$P_{bb'i}$	Active power of line from bus b to b' at hour i (MW)
P_{gi}	Production of generator g at hour i (MW)
P_{gi}^f	Generation of segment f in fuel cost curve (MW)
R_g^U, R_g^D	Ramp- up and down of generator g (MW/h)
SR_{gi}^D	Down-spinning reserve of generator g at hour i (MW)
SR_{gis}^D	Down-spinning reserve of generator g at hour i in scenario s (MW)
SR_{gi}^U	Up-spinning reserve of generator g at hour i (MW)
SR_{gis}^U	Up-spinning reserve of generator g at hour i in scenario s (MW)
SRC_{gi}^D	Down-spinning reserve cost of generator g at hour i (\$/MW)
SRC_{gi}^U	Up-spinning reserve cost of generator g at hour i (\$/MW)
SUC_{gi}	Start-up cost of generator g at hour i (\$)
σ_{gi}	Reserve condition of generator g at hour i
Θ_{bis}	Voltage angle at bus b and hour i in scenario s (rad)
ρ_{bi}	Electricity price at bus b and hour i (\$/MWh)

lem in [17, 18] to improve the grid flexibility. However, demand-side activities have been overlooked. In [19], the authors have proposed a method which evaluates the DR penetration to support the reliability of electricity grids. A probabilistic modelling strategy to maximise the reliability through the DR in emergency conditions has been offered in [20]. However, only the EDRP and incentives have been considered in [19, 20], where no consumers behaviour and no electricity price design were taken into account. Several flexible resources such as a DR program and energy storage units to provide the grid with enough flexibility have been considered in [21]. However, the outages of generation units or transmission lines have not been examined. Besides, the proposed model has mainly focused on the generation-side scheduling and ramp products, where the calculation of optimal electricity rates considering consumers role for optimal scheduling of the demand side has not been studied.

The information gap decision theory (IGDT)-based models have been proposed in [22, 23] to solve the UC problems integrated with DR considering electric vehicles (EVs) and wind power uncertainties. However, contingencies as a result of network component outages and customers behaviour have not been taken into account for an ideal price design. In [24], a security-constrained unit commitment (SCUC) model linked with DR plans has been used in an islanded microgrid to maximise the expected benefits of the operator considering the uncertainties of loads and renewable energy sources. For the optimal scheduling of a virtual power plant considering DR and the influence of the risk on decision making, a stochastic framework has been presented in [25]. The authors have foreseen electricity market prices in price-based DR programs (PBDRPs). However, the calculation of incentives in EDRPs and the consumers' behaviour and comfort indices have not been taken into account in the optimisation model in [24, 25].

A data-driven UC method considering load and renewable production uncertainties has been implemented in [26] to minimise total operating costs while ensuring system safety. A flexible uncertainty set strategy has been introduced in [27] to deal with the uncertain production of renewable energy sources in UC, where DR has been applied to overcome the risk of load shedding and renewable energy curtailment. A set of reserve limits have been elaborated in [28], considering the activation cost of reserves in high renewable-penetrated power systems. A SCUC model considering the coordinated performance of DR and hydrogen storage systems in the presence of wind energy has been presented in [29]. In [30], a scenario-based SCUC model has been introduced considering uncertain wind power generation with the Weibull distribution function. The integration of the aggregated EV fleets and DR into power systems has been studied in [31] using the SCUC to minimise total operating costs and examine the reliability of power systems. The presented UC model in [32] has analysed the frequency dynamics of the power system where the impact of wind turbines, PEVs and DR

have been investigated. While the above-mentioned studies have looked at different aspects of integrated UC and DR models, the consumers' behaviour and comfort indices have not been taken into account in the proposed optimisation models.

According to the literature review, the consequences of outages are reduced by DR, and responsive loads, by adjusting their consumption, help the operators to improve the reliability level. Electricity consumers also desire to minimise their electricity bills by participating in DR programs and appropriate load scheduling. However, participation in DR programs has a great impact on consumers comfort [33]. If consumers perceive difficulty more than the achievable financial compensation, they might refuse a DR program. Moreover, without considering the impacts of human behaviour and comfort, unacceptable errors arise in evaluating the effectiveness of DR strategies. The authors have suggested a DR algorithm in [34] to study the customers' eagerness to participate in a DRP. However, the price design for optimal supply-side scheduling considering network flexibility has not been examined. A DR model in which residential loads are sorted into several categories according to various DR programs has been presented in [35]. However, consumers comfort index, optimum incentives, and reliability measures were not considered.

In [36], a multi-objective algorithm has been applied to solve the scheduling problem. The user preference has been evaluated from the historical usage patterns. A comfort model, which includes psychological aspects and predicts the rate of unsatisfied residents has presented in [37]. While consumers comfort and bill reduction at the residential level is the point of focus in [36, 37], calculation of prices and incentives and reliability constraints have not been included in the proposed model.

System operators or utilities persuade the clients by proposing cost drops as a result of reducing energy consumption or with greater incentives in peak hours, which is more acceptable by customers with less operational restrictions on their loads. While comprehensive models have been offered in the literature regarding the dynamic electricity pricing, a wide range of customers viewpoints regarding the fluctuations of prices and incentives has remained unanswered, where their satisfaction and behaviour have not been addressed thoroughly. Hence, customers behaviour and comfort as fundamental principles must be included in the optimal scheduling of demand units to improve the reliability and efficiency of DR programs [33].

The main aim of this article is to define an accurate model of DR considering customer behaviour and the effect of customers preferences on the optimal power system operation. Instead of focusing on the individual consumption pattern modelling in the residential sector and at the distribution level, the introduced approach focuses on total consumption at the transmission level. This paper further develops a pricing algorithm to find the optimal electricity prices and incentives to guarantee network reliability and customers' comfort, while minimising system opera-

tion costs in the presence of uncertainties. Modified and detailed information of a regression investigation is used for obtaining the reliance of elasticity variables. Two types of consumers are used for modelling the users' involvement in DR. In the employed EDRP, a factor that shows the real value of the incentive payment perceived by the customers is used. Several cases are considered to model the effect of the outage of generators or transmission lines and various behaviour of customers in the operation of power systems.

This article is structured as follows: Section 2 defines the proposed method and problem formulation. Section 3 describes the test system information. Then, the numerical studies and simulation results for different cases are presented in Section 4. Finally, Section 5 describes conclusions and possible future steps.

2. Methodology

This part explains the proposed strategy to combine UC and DRPs, considering network constraints and reliability measures. Contingencies are included in a two-stage SCUC problem by using a probabilistic mixed-integer linear program (MILP) model, and the performance of both supply- and demand-sides are optimised concurrently. The first stage decision variables, which are linked to market-clearing, are given before the scenarios occur. These variables include start-up and shut-down costs, power generation, up and down reserve of each unit, and DR decisions. The second stage variables associated with uncertainties and the real performance of the system consider the values of up and down spinning reserves and the quantity of unintentional load shedding in all scenarios.

2.1. DR formulation

Electricity consumption, like many products, is sensitive to the price. When the electricity price drops, the customers show elasticity and might have the intention to increase the demand. On the other hand, by an increase in the electricity price, consumers try to reduce their consumption. To model this sensitivity during DRPs, the concept of elasticity of demand is used in this paper.

The elasticity of demand, which is shown in (1), is defined as the electricity demand change at i^{th} interval Δd_i concerning the variation of electricity price at j^{th} period $\Delta \rho_j$. Elasticity matrix contains self and mutual elasticity elements (see (1)). ρ_j^0 and d_i^0 are the baseline price and demand at hours j and i , respectively.

$$E_{ij} = \frac{\rho_j^0 \Delta d_i}{d_i^0 \Delta \rho_j} \quad \text{is} \quad \begin{cases} \leq 0, & \text{if } i = j \\ \geq 0, & \text{if } i \neq j \end{cases} \quad (1)$$

2.1.1. Customers rationality

A crucial point in the description of consumers' behaviour relates to the time range of consumers rationality. The price elasticity matrix (PEM), which measures consumers' sensitivity to the price, will have non-zero records

Table 1: A section of PEM for LRCs.

h	7	8	9	10	11	12	13
2	0.01	0.01	0.01	0.012	0.012	0.013	0.013
...
7	-0.01	0.017	0.018	0.019	0.02	0.022	0.021
8	0	-0.01	0.015	0.016	0.018	0.019	0.019
9	0	0	-0.02	0.015	0.017	0.018	0.016
10	0	0	0	-0.05	0.015	0.016	0.017
11	0	0	0	0	-0.1	0.02	0.016
12	0	0	0	0	0	-0.16	0.02

Note: Elasticity coefficients corresponding to Row 2 and 7 through 12 for columns 7 through 13 for LRCs.

only within a time range that the perception of consumers goes over. Considering the time range, customers could be classified into five different types. The first type is the short-range consumers (SRCs) who do not optimise their consumption and think only about the price at the current time interval. They could, therefore, be represented by a diagonal PEM. The ideal consumers are defined to be the ones who take a long-range outlook in decision making. In that way, the long-range consumers (LRCs) choose how to shift and optimise their consumption over a wide range of hours following variations in prices. The PEM of the LRCs might have non-zero coefficients anywhere during the 24 hours. The third type covers deferring consumers who pay attention to the current and future prices only. These consumers, unlike LRCs who optimise their load throughout the day, change their consumption over a shorter range of hours into the future. On the other hand, the behaviour of advancing customers is affected by current and past prices. The PEMs of these consumers would be similar to deferring consumers except that there will be non-zero elements on and above the diagonal indicating their insight into current and past periods. Finally, mixed consumers (MCs) whose electricity demand is influenced by past, present and future electricity rates. The elasticity values for LRCs in [38] are used along with new elasticity coefficients for MCs depending on the rationalities explained above. A mixture of postponing, advancing, and short-range consumers is taken into account here. It is assumed that the awareness of MCs goes into six earlier and forthcoming hours. Non-zero elements will be on both sides of the diagonal in the PEM of MCs. Tables 1 and 2 show the PEM sections for LRCs and MCs, respectively.

Another notable point is that the behaviour of customers in PBDRPs, where real-time (RT) prices are applied, is different than their behaviour in EDRPs. Losses have a greater impact than the effect of benefits on the customers' preferences. In PBDRPs, where the highest prices are set for the peak hours, consumers perceive any load shift to the off-peak hours as a loss. On the other hand, in an EDRP, customers see the obtained remunerations by load reduction and/or load shifting as profits. Hence, while the implementation of both programs needs

Table 2: A Section of PEM for MCs.

h	16	17	18	19	20	21	22
16	-0.04	0.025	0.025	0.02	0.017	0.015	0.014
17	0	-0.16	0.1	0.08	0.025	0.02	0.017
18	0	0	-0.45	0	0	0	0
19	0	0	0.019	-0.25	0	0	0
20	0	0	0.02	0.019	-0.22	0	0
21	0	0	0.03	0.025	0.02	-0.2	0
22	0	0	0.033	0.027	0.021	0.022	-0.18

the same action, customers perceive the results as penalties and rewards which have opposite effects on their decision making. In this concept, the perceived effect of penalties or losses is steeper than perceived values of rewards and gains [39, 40]. Thus, the felt value by consumers, which they respond to, is not the same as the given value of the imposed prices or offered incentives. ψ is a weighting factor speaking for the value perception of the incentive remunerations.

Considering the above-mentioned points, the proposed method modifies the general economic model of DR presented in [41] by considering the loss-gain factor and adding constraints related to consumers payment and consumption way to contemplate the behavioural aspects and preferences of consumers. Accordingly, optimal electricity prices in PBDRPs and optimum incentives in EDRPs are calculated to manage the electricity consumption.

So, the term ψA_{bj} is included in the DR model to compare the results of PBDRPs and EDRPs. The relation between power price ρ_{bj} and the electricity consumption level at each bus d_{bi} is made clear in (2) as the increase of tariff and reward A_{bj} at each bus and hour can flatten the consumption profile in the peak hours, however, the degree of load decline is not identical. ρ_{bj}^0 and d_{bi}^0 are the baseline price and demand at bus b and hours j and i , respectively.

$$d_{bi} = d_{bi}^0 \left[1 + \frac{\sum_{j=1}^{24} E_{ij} (\rho_{bj} - \rho_{bj}^0 + \psi A_{bj})}{\rho_{bj}^0} \right] \quad (2)$$

Fig. 1 shows the process of calculating RT rates and incentives for PBDRPs and EDRPs considering the objective function and given constraints. The goal is to determine the incentives and the price deviations $\Delta\rho_{bi}$ from the base line price ρ_{bj}^0 to minimise the net operation costs and ensure system reliability. First, the conventional UC is performed to find the flat rate, and consequently, RT prices in PBDRPs and incentives during peak hours in EDRPs for all buses are obtained. After calculating RT rates and incentives at each load bus and time, the modified demand profile is entered as an input to the supply-side scheduling section. This link between supply and demand sides could ensure a flexible and efficient power system operation. Finally, the output variables of economic and flexibility operation targets of ISO are extracted as outputs.

2.1.2. DR constraints

Several constraints must be considered to find a suitable pricing programme. It is acceptable to allocate the lowest price to the period with minimum consumption level, fifth period here [42]. Consequently, the electricity price ρ_{bi} compared to the the baseline rate ρ_{bi}^0 should raise according to the electricity demand at each hour. Twenty-four limitations for change in prices are considered (see (3)). The larger the consumption of hour i is, the larger $\Delta\rho_{bi}$ should be set for that hour. This variable is negative for ($i=2-8$), which suggests lower rates than the flat rate. $\Delta\rho_{bi}$ assumed as a free variable for ($i=1, 9, 14-16, 23-24$) and as a positive variable for the remaining hours, which means consumers are charged with higher rates than the flat rate.

$$\Delta\rho_{bi} = \frac{\rho_{bi} - \rho_{bi}^0}{\rho_{bi}^0} \quad (3)$$

In addition to the PBDRP, as mentioned before, an EBDPR is also analysed along with the SCUC problem. By dividing the peak hours into three peak periods, it is acceptable to designate the higher incentive values to the periods with more consumption. To have a suitable incentive scheme, inequality (4) have been considered to define the logical range of incentives in peak hours. TLP represents the hours with lower peaks ($i=10-13, 17, 21-22$), TMP represents the hours with medium peaks ($i=19, 20$) and THP represents the peak period with the highest consumption, $i=18$.

$$0 \leq A_b^{TLP} \leq A_b^{TMP} \leq A_b^{THP} \quad (4)$$

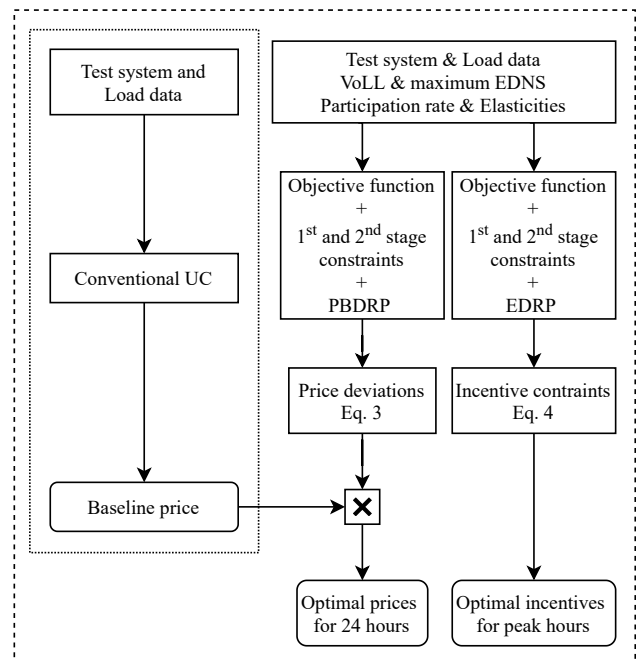

Figure 1: Method to find real-time prices and incentives.

$$\begin{aligned}
OF = & \sum_{i=1}^H \sum_{g=1}^G \left[FC_{gi} I_{gi} + SUC_{gi} + SRC_{gi}^D SR_{gi}^D + SRC_{gi}^U SR_{gi}^U \right] + \\
& \sum_{s=1}^S \alpha_s \left[\sum_{i=1}^H \sum_{g=1}^G \left(SRC_{gi}^D SR_{gis}^D + SRC_{gi}^U SR_{gis}^U \right) + \sum_{i=1}^H \sum_{b=1}^B V_{bi}^{Sh} L_{bis}^{Sh} \right]
\end{aligned} \tag{10}$$

The maximum available demand at each bus, which can be changed at different hours, is shown in (5). \overline{DR}_b is the maximum consumers' reply to DR signals at bus b . The maximum DR potential for demand modification is assumed to be 15% at all load buses, which guarantees a load increase at low-load or off-peak hours does not create a larger peak for the system.

$$-\overline{DR}_b d_{bi}^0 \leq \Delta d_{bi} \leq \overline{DR}_b d_{bi}^0 \tag{5}$$

As mentioned before, if the proposed method ignores customers' preferences, the optimum points can make an undesirable load shifting and affect the customers' comfort. Consumption way and payment indices are used in this paper to conceive the consumers' satisfaction. The constraints for consumption way index CWI and the payment index PI are formulated as (6) and (7), respectively. Customers ideally prefer not to change their consumption or minimise it. Thus, smaller Δd_i and larger CWI show that consumers face less discomfort. Undeniably, a larger PI will overall reduce customers payment CP_i and bring more satisfaction. ΔCP_i is the change in consumers' payment at hour i . Lower bounds for CWI and PI are extracted from [43]. Moreover, to guarantee the users convenience, it is ensured by (8) that the overall energy usage at every bus remains unchanged during the DR exertion. The average consumption delay index CDI (9) is also considered to show the average time that consumers shift the usage time of one MW electricity while participating in DR programs compared to the situation without demand response implementation. Δd_{ij} is the exchanged demand between hours i and j .

$$CWI = \frac{\sum_{i=1}^{24} d_i^0 - |\Delta d_i|}{\sum_{i=1}^{24} d_i^0} \geq 0.95 \tag{6}$$

$$PI = \frac{\sum_{i=1}^{24} CP_i - \Delta CP_i}{\sum_{i=1}^{24} CP_i} \geq 1.02 \tag{7}$$

$$\sum_{i=1}^H \Delta d_{bi} = 0 \tag{8}$$

$$CDI = \frac{\sum_{j=1}^{24} \sum_{i=1}^{24} |\Delta d_{ij}| |i - j|}{\sum_{i=1}^{24} |\Delta d_i|} \tag{9}$$

2.2. Objective function

The proposed model aims to schedule the units at minimum production costs without jeopardising the system security when the system encounters contingencies. The objective function (see (10)) covers seven terms, among which terms 1–4 are linked to first-stage choices, and terms 5–7 are associated with the second stage. The first-stage choices are made before the realisation of scenarios in contingencies. Hence, a conventional UC problem is performed in the first stage to define the commitment status of generators and their programmed energy and reserve capacity. The reliability limits of the system are examined after the realisation of scenarios in the second stage. A DC optimal power flow is performed in the second stage to optimise the volume of deployed down- and up-spinning reserves and load curtailment in each scenario. In this manner, the system security will be guaranteed based on the desired maximum expected demand not served (EDNS) value set by the system operator.

Precisely, the first and second terms handle the energy costs and the start-up costs of generators, third and fourth terms calculate the costs of scheduling down- and up-spinning reserves, fifth and sixth terms define the costs associated with the deployment of down- and up-spinning reserves in scenarios, and the last term is the costs of load shedding. So, the stage two in the proposed model includes the costs of providing supply-load balance in scenarios.

Looking at (10), H , G , S , and B are the number of scheduling hours, generating units, scenarios, and buses, respectively. FC_{gi} , I_{gi} , and SUC_{gi} are the fuel cost, the commitment state, and the startup cost of unit g at hour i , respectively. SRC_{gi}^D and SR_{gi}^D are the down-spinning reserve cost and the down-spinning reserve of production unit g at hour i . Similarly, SRC_{gi}^U and SR_{gi}^U are the up-spinning reserve cost and the up-spinning reserve of generator g at hour i . α_s is the probability of scenario s . SR_{gis}^D and SR_{gis}^U are the deployed down- and up-spinning reserve of unit g at hour i in scenario s , respectively. V_{bi}^{Sh} is the value of lost load in bus b at time i , and L_{bis}^{Sh} is the load shedding in bus b at time i in scenario s .

In case of the EBDPR, IC which calculates the amount of incentive payed to the customers will be added to the objective function. This term has been linearised using [44] in order to fit in the linear model of this paper.

$$IC = \sum_{i=1}^H \sum_{b=1}^B A_{bi} (d_{bi}^0 - d_{bi}) \tag{11}$$

It should be mentioned that the authors have considered the following assumptions:

- It is assumed that shut down costs are negligible compared to other expenses such as startup costs.
- Losses over transmission lines are ignored.
- The piece-wise linear approximation is adopted for the incremental cost function of thermal units to facilitate reaching a real-time solution without a notable impact on the accuracy.
- Outage of a generator or a transmission line is taken into account in contingency events as multiple outages have approximately low possibilities while adding more computational complexity.
- The optimisation problem might become unsolvable as the payment index constraint could create a non-linear constraint. Price and demand variables are decoupled to linearise this constraint.

2.2.1. First stage constraints

The first stage constraints are given in this section. The costs of generation units are defined as an incremental cost function in a linear piece-wise form. The generation cost of generator g at hour i is given by (12).

$$FC_{gi} = \underline{FC}_g I_{gi} + \sum_{f=1}^F \beta_{fg} P_{gi}^f \quad (12)$$

where $0 \leq P_{gi}^f \leq \overline{M}_{fg}$

\underline{FC}_g is the minimum fuel cost of generator g and F is the number of segments in piece-wise linearised fuel cost. β_{fg} , P_{gi}^f , and \overline{M}_{fg} are the slope, the generation, and the maximum production of segment f in cost curve of the generator g , respectively.

The linear relation of the total scheduled power of the generation unit P_{gi} is defined by (13). \underline{P}_g is the minimum production of generator g .

$$P_{gi} = \underline{P}_g I_{gi} + \sum_{f=1}^F P_{gi}^f \quad (13)$$

- Start-up cost constraints of generation units

$$0 \leq SUC_{gi} \leq K_g (I_{gi} - I_{g,i-1}) \quad (14)$$

where SUC_{gi} is the startup cost of unit g at hour i , K_g is the start-up cost of generator g , and I_{gi} is the commitment status of generator g at hour i .

- Constraints of spinning reserves

Constraints of down- and up-spinning reserves are shown in (15) and (16). \overline{P}_g is the maximum production of generator g . SR_{gi}^D and SR_{gi}^U are the down- and up-spinning

reserves of generator g at hour i . R_g^D and R_g^U are ramp-down and ramp-up of generator g . T is the spinning reserve market lead time.

$$P_{gi} + SR_{gi}^U \leq \overline{P}_g I_{gi}, \quad P_{gi} - SR_{gi}^D \geq \underline{P}_g I_{gi} \quad (15)$$

$$0 \leq SR_{gi}^U \leq R_g^U T, \quad 0 \leq SR_{gi}^D \leq R_g^D T \quad (16)$$

- Up and down constraints of generation units

$$P_{gi} - P_{g,i-1} \leq R_g^U I_{gi} + \underline{P}_g (1 - I_{g,i-1}) \quad (17)$$

$$P_{g,i-1} - P_{gi} \leq R_g^D I_{g,i-1} + \underline{P}_g (1 - I_{gi}) \quad (18)$$

- Time constraints of generation units

$$\sum_{j=i+2}^{i+T_g^+} (1 - I_{gj}) + T_g^+ (I_{gi} - I_{g,i-1}) \leq T_g^+ \quad (19)$$

$$\sum_{j=i+2}^{i+T_g^-} I_{gj} + T_g^- (I_{g,i-1} - I_{gi}) \leq T_g^- \quad (20)$$

- Ramp-down and ramp-up constraint

$$P_{gi} - P_{g,i+1} \leq R_g^D, \quad P_{g,i+1} - P_{gi} \leq R_g^U \quad (21)$$

- Active power equilibrium

The power balance between loads and generation units on each bus is ensured by (22). P_{gi} and $P_{bb'i}$ are the production of generator g and the active power of the transmission line from bus b to bus b' at hour i , respectively. $X_{bb'}$ and Θ_{bi} are the line reactance from bus b to bus b' and the voltage angle at bus b and hour i , respectively.

$$\sum_{g=1}^{G_b} P_{gi} - d_{bi}^0 - \Delta d_{bi} = \sum_{b'=1}^B P_{bb'i} \quad b' \neq b \quad (22)$$

$$\text{where } P_{bb'i} = \frac{1}{X_{bb'}} (\Theta_{bi} - \Theta_{b'i})$$

2.2.2. Second stage constraints (depending on scenario s)

The outage scenarios are taken into account by the equations of stage 2, which are given hereafter. Examining reliability measures in scenarios depends on the determination of contingencies which could be done by enumeration techniques. Once the set of contingencies are determined, one must focus on analysing their possibility. The forced outage rate (FOR) of components in each contingency is employed to calculate the failure possibility α_s (see (23)). c' is the failed component, c is the index of components, and C is the number of components.

$$\alpha_s = FOR_{c'} \prod_{\substack{c \in C \\ c \neq c'}} (1 - FOR_c) \quad (23)$$

FOR is calculated based on the statistical data of that component using (24), where MTTR and MTTF stand for mean time to repair and mean time to failure, respectively.

$$\text{FOR} = \frac{\text{MTTR}}{\text{MTTR} + \text{MTTF}} \quad (24)$$

- Active power equilibrium considering scenarios

The frequency stability issues as a result of contingency events are one of the main concerns of system operators. However, the balance between generations, losses and loads ensures frequency stability throughout the system. In contingency events, power balance at each bus is ensured by loads and generators. So, the applied DC power flow equation to the system is shown in (25). τ and v present the availability condition of transmission lines and generation units, respectively. During the component outages, they are set to 0 while they are 1 otherwise.

SR_{gis}^U and SR_{gis}^D are the up- and down-spinning reserves of generator g at hour i in scenario s . L_{bis}^{Sh} represents the amount of load curtailment at bus b . P_{lis} is the active power of transmission line l at hour i from bus b to b' in scenario s , while \bar{P}_l is the maximum allowable power on line l .

$$\sum_{g=1}^{G_b} v[P_{gi} + SR_{gis}^U - SR_{gis}^D] - d_{bi} - L_{bis}^{Sh} = \sum_{l \in L_b} \tau P_{lis}$$

where $-\bar{P}_l \leq P_{lis} = \frac{1}{X_{bb'}}(\theta_{bis} - \theta_{b'is}) \leq \bar{P}_l$ (25)

- Constraints of spinning reserves in contingencies

The reliability of the system is secured by down- and up-spinning reserves together with DR plans when the system operator monitors changes in demand-side behaviour or the component availability status. The relationship between the first- and the second-stage spinning reserve variables is specified in (26).

$$0 \leq SR_{gis}^U \leq \sigma_{gis} SR_{gi}^U, \quad 0 \leq SR_{gis}^D \leq \sigma_{gis} SR_{gi}^D \quad (26)$$

where σ_{gis} is the reserve state of generator g at hour i in scenario s , which is 0 if the unit outage has occurred and otherwise it is considered 1. It ensures that only available production units in scenarios would provide spinning reserves.

- Load shedding constraint

The generation shortage may cause involuntary load shedding to ensure the system security. It is guaranteed by (27) that the amount of load shedding in each scenario at each bus remains less than the electricity consumption of the respective bus.

$$0 \leq L_{bis}^{Sh} \leq d_{bi} \quad (27)$$

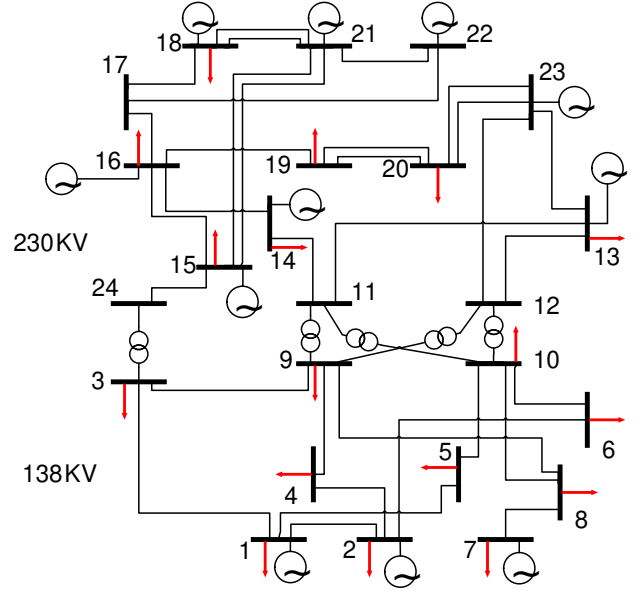

Figure 2: Schematic of the 24-bus reliability test system

2.3. Reliability assessment

Using [45], to measure the reliable scheduling this paper employs an expected demand not served (EDNS) index, which is achievable by multiplying the value of load shedding and the likelihood of the component failure in each scenario s at bus b and hour i (see (28)). As shown in (28), the continuous power generation and consumption are guaranteed by the highest permitted amount of EDNS, which is set by the system operator.

$$EDNS_i = \sum_{b=1}^B \sum_{s=1}^S \alpha_s L_{bis}^{Sh} \leq \overline{EDNS} \quad (28)$$

3. Test system

Fig. 2 shows the IEEE 24-bus test system with overall generation and load capacity of 3405 MW and 2850 MW, respectively. The generation and consumption data, ramp rates, reliability factors, cost coefficients etc., are taken from [42].

The load profile is divided into three sections, including low consumption (2-8), off-peak (1, 9, 14-16, 23-24) and peak (10-13, 17-22) hours. The value of the lost load (VoLL) is set to 150, 300 and 450 \$/MWh for low-load, off-peak and peak periods, respectively. The maximum amount of EDNS is assumed 7 MW to ensure the required reliability.

4. Results and discussion

The electricity generation planning without and with implementing DR are studied hereafter. First, the authors obtained \$701202 as the total system operating costs in the absence of contingency events and DR programs. By

analysing component contingencies using the $N - 1$ criterion and under a flat rate price scheme, the system operator has to provide the required flexibility by optimal supply-side scheduling. As a result, a unit commitment is obtained with the total operation cost of \$831991. This 18.7% increase in operating cost compared to the condition without contingencies is because of the extra costs due to the provision of reliability as in such times, the peak load production units should be started up and run at a non-economic point.

The proposed model is also applied to the system once without considering reliability constraints, where the maximum amount of EDNS are ignored, and the influence of a contingency event on the system functioning is taken into account. As a result of ignoring the upper limit of 7 MW for EDNS, the higher average amount of calculated compulsory load shedding (40.8 MW) compared to the cases which consider this limit brings more consumers dissatisfaction with the whole operation costs of \$757650.

Then, in the absence of DR, but by considering the maximum amount of EDNS as the reliability constraint \$831991 and 4.98 MW are calculated as the total calculated operation cost and the average amount of EDNS, respectively. The \$74341 increase in the operating cost compared to the case without limit for EDNS should be spent to supply the reliability necessities in case of contingency events.

To study the effect of DR programs on system reliability in case of component contingencies, the price- and incentive-based DR programs are investigated in 2 cases. In the first case, where the total daily energy consumption should remain constant (see (8)), the proposed model aims to ensure the reliable and the flexible operation of the system by finding optimal hourly electricity prices. To guarantee the reliability, the EDNS should be below 7 MW at all buses and each hour. In the second case, constraints of energy, consumption way, and payment are neglected, and the target of implementing EDRP and PBDRP is the reduction of peak loads where the calculated hourly rates from the first case and incentives are applied. In the following sections, two cases are examined, in which LRCs and MCs are modelled by allocating DR patterns come from their PEMs. Besides, a behavioural factor is considered to show the various response of customers to incentives and punishments. The optimal electricity price at each hour in PBDRPs and optimum incentives at peak hours in EDRPs are calculated to minimise the total system operational cost and ensure the system reliability.

4.1. Case 1: DR with constant total energy consumption

In addition to the generation side scheduling, both reliability constraints and demand-side response are integrated into the problem in this case. Consequently, the load profile is modified according to the consumers' response to the electricity rates. Fig. 3 gives the average RT tariffs for different types of customers. LRCs, compared to MCs, face prices with more deviation at low-load and

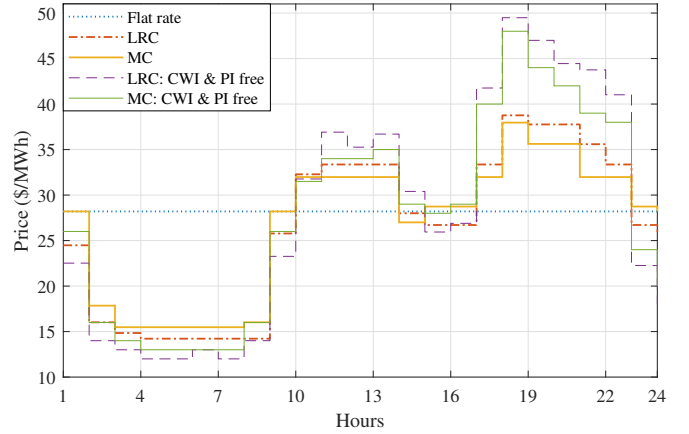

Figure 3: RT rates at each hour in Case 1

peak hours. While the average and the standard deviation of the electricity price for LRCs are 26.4 and 8.8, respectively, these parameters are calculated 26.8 and 7.5 for MC consumers. Calculated rates prove the ability of DR to decrease the average of electricity prices for consumers.

Fig. 4 shows the influence of applying optimised RT rates on the load profile. During the peak hours, because of the higher rates, electricity consumption is reduced and shifted to the low-load hours, where electricity prices are much lower. Notably, compared with MCs, LRCs have a flatter load profile because of more price deviation where they face lower rates at low-load hours and higher rates at peak hours.

The results of applying the PBDRP in Case 1 are summarised in Table 3. The operational costs when LRCs and MCs participate in DR are reduced by 3.2% and 2.9%, respectively. Despite the reduction of operation cost, energy consumption remains invariable for all customers. The role of DR in decreasing consumers payments is also confirmed by the given results. Given CWI , PI , and the

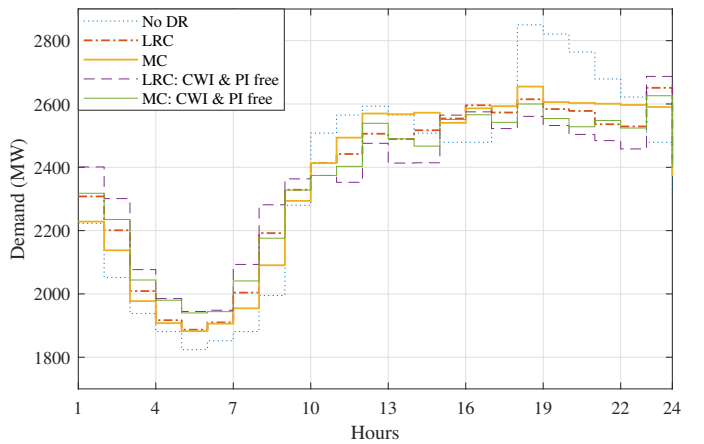

Figure 4: Demand profiles in Case 1

Table 3: Results of the PBDRP implementation.

	Operation cost (\$)	Consumers payment (\$)	Peak _{avg} (MW)	PI	CWI	CDI (Hour)	$EDNS_{avg}$ (MW)
Without DR	831991	1600100	2656	1	1	0	4.98
Long-range customers	805209	1559200	2527	1.03	0.95	6.1	2.05
	96.78%	97.44%	95.14%				
Mixed customers	807697	1575900	2570	1.02	0.97	3.9	2.16
	97.08%	98.49%	96.74%				
Long-range customers	790008	1620530	2468	0.99	0.93	6.6	2.05
(No limit for CWI , PI)	94.95%	101.28%	92.92%				
Mixed customers	797605	1625804	2510	0.98	0.94.5	4.3	2.16
(No limit for CWI , PI)	95.87%	101.61%	94.50%				

average EDNS indices in Table 3 show that the proposed method meets all the reliability and customers satisfactory constraints. Although LRCs change their load more than MCs and have lower CWI , higher PI shows the lower cost they should pay. Compared to MCs, the larger value for the average consumption delay index CDI between LRCs makes them more competent to shift their loads and reduce the average peak and EDNS values. The calculated values for EDNS confirm the efficiency of DR implementation to ensure the system reliability. As it is depicted in Fig. 5, the value of EDNS in all hours is always less than 7 MW, and generally decreases after using DR programmes compared with the base case without (W/O) DR implementation.

The authors have also obtained the rates for a situation that ignores the limits of CWI and PI . As a result of neglecting CWI limit, the model reduces the load as much as possible during a contingency event to reduce the costs of the generation side by minimising the start-up and generation costs of expensive units, which is not close to real situations. On the other hand, by neglecting the limit for PI , the model changes the loads in a way to increase the CWI and decrease the EDNS. As a result, the customers' payment will increase, which causes monetary dissatisfaction for consumers. For a situation that ignores the limits

of CWI and PI , the prices (see Fig. 3) and electricity demand (see Fig. 4) have changed more violently, new peaks have emerged, and CWI and PI got worse (see Table 3) compared to the cases where a limit for those indices was set. The results show that operation costs in such a situation have been decreased, while the customers experience an increase in their payments. The outcome of such a scenario would be reduced customers' satisfaction which was reflected in 2.5% and 4% decrease in CWI and PI , respectively.

Fig. 6 shows how DR programs could affect the generation mix. The legend show bus numbers. In contingency events and without DR implementation, the system operator must commit expensive units, located at Buses 1, 2, 7, and 13 to secure the system reliability. After DR implementation, where the load can shift between periods, expensive units could be committed for fewer hours at peak period compared to the situation without DR implementation.

As it can be seen in Fig. 6, the proposed method have decreased the generated power of units located at mentioned buses in peak and off-peak hours (Note: Buses 1, 2, 23: Coal/Steam, Buses 7 and 13: Oil/Steam, Buses 18 and

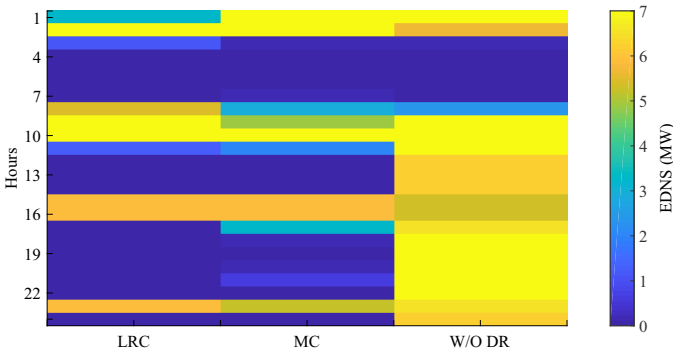

Figure 5: Calculated hourly EDNS values in different situations

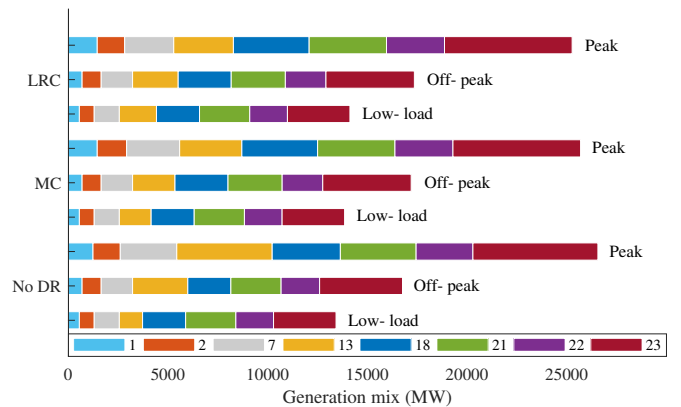

Figure 6: Effect of DR programs on the generation mix

Table 4: Results of implementing PBDRP, EDRP1, and EDRP2 for $\psi = \frac{1}{4}$

	Scenario	Peak _{avg} (MW)	Payment (\$)	CWI	PI	CDI (Hour)
Mixed consumers	PBDRP	2459 (-7.4%)	1544745	94.22%	1.03	2.5
	EDRP1	2486 (-6.4%)	1585900	94.02%	1.01	1.2
	EDRP2 ($\psi = \frac{1}{4}$)	2405 (-9.5%)	1542985	93.91%	1.04	1.3
Long-range consumers	PBDRP	2367 (-10.8%)	1527847	92.46%	1.05	3.3
	EDRP1	2430 (-8.5%)	1568439	91.87%	1.02	1.6
	EDRP2 ($\psi = \frac{1}{4}$)	2309 (-13.0%)	1516647	91.60%	1.06	1.7

 Table 5: Calculated A_i (\$/MWh)

Hour	10-13	17	18	19,20	21,22
MC	12.2	9.0	15.0	14.3	12.1
LRC	12.0	9.0	14.7	14.0	12.0

21: Nuclear and Bus 22: Hydro). In the case of LRCs, the mentioned units are committed for fewer peak hours compared to the MCs. Therefore, the reduced operation costs of the mentioned units have affected the total operation costs of the system, which are given in Table 3.

4.2. Case 2: DR without energy constraint

EDRPs are also run for two types of consumers with different response characteristics. In this case, the energy consumption, consumption way and payment constraints are neglected, and it is assumed that the system operator is interested in reduction in electrical energy consumption during the peak period. So, in addition to the PBDRP, two options for the EDRP are studied. EDRP1 is an option without considering the loss-gain factor ($\psi = 1$). EDRP2 is the other choice that the loss-gain parameter changes in a range ($\frac{1}{8} \leq \psi \leq 1$). As explained before in Section 2, the loss-gain factor interprets a behavioural tendency where people are afraid of losses, and hate losing more than they like winning. Thus, losses appear to be more than the earnings even though the value in monetary terms might be equal. For example, for ($\psi = \frac{1}{4}$), it is assumed that loss of every dollar has the forth value of every dollar gained and so on.

The calculated incentives would cause a reduction in the peak hours demand, which reduces the burden on the generation side and the operation costs. On the other hand, the calculated incentives add costs to the system operator side due to the reward payments to the customers, which will be added to the objective function for this case.

It is acceptable to consider the highest incentive value to the period with a maximum consumption level. Consequently, the incentive values should decrease according to the electricity demand decrease at each peak hour. Thus similar to the procedure of finding the optimal prices in Case 1, the incentives for peak hours would be calculated. The calculated average rewards per MWh demand reduction compared to the baseline demand in EDRPs are given

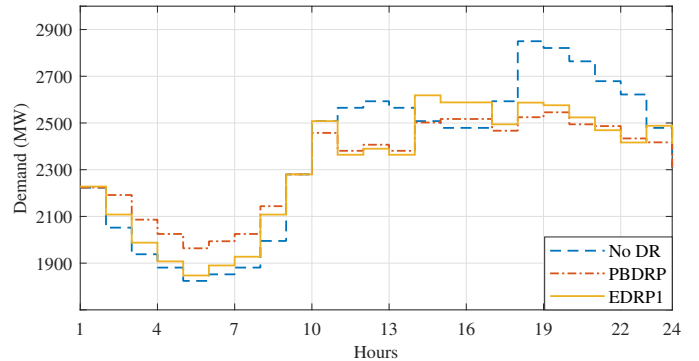

Figure 7: Demand profiles for mixed customers in Case 2

in Table 5. Accordingly, the load profiles are modified according to the consumers' response to the incentives. Obtained incentives show that LRCs expect less remuneration payments than MCs in peak hours. Fig. 7 and Fig. 8 illustrate the influence of applying planned RT tariffs and rewards on the load profile for MCs and LRCs. Same as Case 1, LRCs have a flatter load profile and get better results.

According to the results shown in Table 4 and Fig. 9, both the EDRP and the PBDRP reduce the peak demand and, as a result, the operation costs, which are favourable by the system operators. On the other hand, the customers' payment and consequently, the utility revenue will decrease. The obtained results for CWI and PI show how

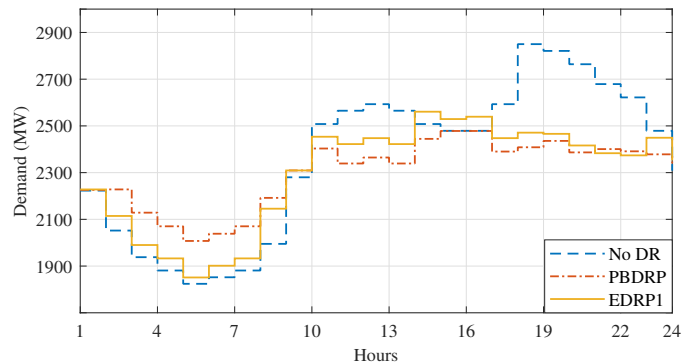

Figure 8: Demand profiles for long-range customers in Case 2

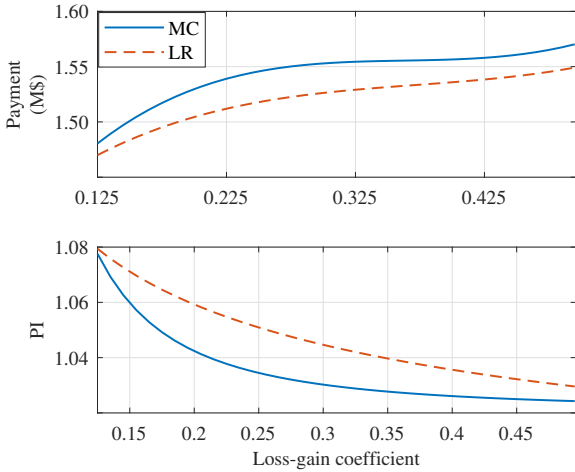

Figure 9: Results for $0.125 \leq \psi \leq 0.5$

ignoring their related constraints in Case 2 could affect the customers' bill and demand change. From the utility point of view, as long as $\psi \geq \frac{1}{3}$, the utility achieves its target better with EDRP, losing the less amount of revenue compared to PBDRP. On the other hand, taking the loss-gain factor $\psi \leq \frac{1}{4}$ into account, PBDRP acts better than EDRP. It is clear that when loss-gain parameter changes in a range of ($\frac{1}{8} \leq \psi \leq 1$), the amount of ψA_i should be constant to get comparable change in the peak load. So, optimal incentive values should be offered to each type of customers during peak hours. The values of ψA_i , which are given in Table 5 prove the reliance of the offered incentives on the reward weighting factor ψ .

4.3. Computational complexity and implementation issues

To solve the proposed mixed-integer programming model the CPLEX as a high-performance solver is used. CPLEX optimisers have been widely used by researchers to solve large and complex problems swiftly and with minimum user interference [44, 46, 47]. Each case has been run in less than 5 minutes on a 2.11 GHz Windows-based system with 16 GB of RAM. Thus, the proposed optimisation problem can be solved nearly in real-time, providing a fast response to changes in power system situations, electricity prices, or electricity demand. The optimisation problem might become unsolvable as the payment index limit could create a nonlinear constraint. To linearise this constraint, price and demand variables are decoupled.

With an increase in the problem size, the run time could increase exponentially, which brings significant burdens for solving scheduling problems. However, to analyse a system with a large number of buses, lines, and scenarios some possible solutions are available. One of the most practised approaches to overcome the computational complexity of large MILP models originates from the idea of decomposition, which divides a large problem into smaller non-complex subproblems. Reducing the number of scenarios and using supercomputers and methods to simplify

the network are other available options to cope with computational complexity while considering larger systems in case studies.

5. Conclusion

This article introduced a probabilistic day-ahead security-constrained scheduling problem with various integrated demand response programs considering consumers rationality for managing the contingency events. DR has been formed as a responsive shiftable/curtailable demand bidding mechanism that moves the consumption from peak hours to off-peak or low-load hours and ensures social welfare. This work emphasised the influence of consumers representation on the power system performance. The offered model studied the constraints of customers preferences in addition to the constraints of the traditional unit commitment algorithms.

The offered probabilistic model was formulated as a mixed-integer linear programming problem that deals with the security-constrained unit commitment. Both incentives and hourly electricity prices were calculated in emergency and price-based demand response programs. The electricity consumption was adjusted by demand response to control the outages in the power grid, and hence, the modified demand profile helped the system operator to reduce the start-up and reserve costs of generation units. The achieved results validated the ability of the suggested approach in decreasing the operational costs of the system, customers payment, and peak load by optimal scheduling of generation units and optimal use of the demand response potential without bringing notable discomfort to the customers.

The results also showed that consideration of different demand response programs, different types of consumers and comfort constraints have a significant impact on power system reliability and minimising daily operation cost. Overall, meaningful insight into system performance with real-time prices and incentives was obtained. Results proved that system behaviour depends not only on the degree of consumers' elasticity but also on the time range of customers rationality. The implementation of optimal system dispatch necessitates the modelling of time-dependent elasticity to find the optimal scheduling solutions at different hours.

The impact of the loss-gain factor on the results of the demand response programs for peak reduction proved that when people are in a position where both earnings and losses are likely, they normally favour less risky options. If possible losses could be destructive or threaten customers' lifestyle, they will generally reject the choice of participation in demand response programs that bring losses and discomfort. This is one reason for system operators to optimise the prices for reducing the customers' losses at peak-price periods, while they make sure that it can minimise the system operation costs. By limiting potential losses and maximising profits, current consumers will continue

providing demand response and new consumers might join the demand response programs too.

Hence, the explained method could be used to determine optimal scheduling plans, and grid operators together with consumers could benefit from the offered method to schedule the generations units and loads in a way that meets the customers demand while the network reliability and consumers comfort are guaranteed. In real applications, the stochastic nature of renewable energy production or consumers energy consumption would affect the results which should be considered in future works. Besides, competitions in the electricity and reserve markets in addition to minimising CO₂ emissions and consumers payments by forming a multi-objective optimisation problem could be taken into account in later studies.

References

- [1] O. Sadeghian, M. Nazari-Heris, M. Abapour, S. S. Taheri, K. Zare, Improving reliability of distribution networks using plug-in electric vehicles and demand response, *Journal of Modern Power Systems and Clean Energy* 7 (5) (2019) 1189–1199.
- [2] B. Vahidi, A. Dadkhah, New demand response platform with machine learning and data analytics, in: *Demand Response Application in Smart Grids*, Springer, Cham, 2020, pp. 113–137.
- [3] F. Wang, H. Xu, T. Xu, K. Li, M. Shafie-Khah, J. P. Catalão, The values of market-based demand response on improving power system reliability under extreme circumstances, *Applied Energy* 193 (2017) 220–231.
- [4] Y. Li, Z. Yang, G. Li, Y. Mu, D. Zhao, C. Chen, B. Shen, Optimal scheduling of isolated microgrid with an electric vehicle battery swapping station in multi-stakeholder scenarios: A bi-level programming approach via real-time pricing, *Applied Energy* 232 (2018) 54–68.
- [5] M. Kermani, E. Shirdare, A. Najafi, B. Adelmanesh, D. L. Carni, L. Martirano, Optimal self-scheduling of a real energy hub considering local dg units and demand response under uncertainties, *IEEE Transactions on Industry Applications*.
- [6] M. Kermani, E. Shirdare, A. Najafi, B. Adelmanesh, D. L. Carni, L. Martirano, Optimal operation of a real power hub based on pv/fc/genset/bess and demand response under uncertainty, in: *2020 IEEE Industry Applications Society Annual Meeting*, IEEE, 2020, pp. 1–7.
- [7] A. Dadkhah, D. Bozalakov, J. D. De Kooning, L. Vandeveld, On the optimal planning of a hydrogen refuelling station participating in the electricity and balancing markets, *International Journal of Hydrogen Energy* 46 (2) (2021) 1488–1500.
- [8] A. Dadkhah, D. Bozalakov, J. D. De Kooning, L. Vandeveld, Optimal sizing and economic analysis of a hydrogen refuelling station providing frequency containment reserve, in: *2020 IEEE International Conference on Environment and Electrical Engineering and 2020 IEEE Industrial and Commercial Power Systems Europe (EEEIC/I&CPS Europe)*, IEEE, 2020, pp. 1–6.
- [9] M. Vallés, A. Bello, J. Reneses, P. Frías, Probabilistic characterization of electricity consumer responsiveness to economic incentives, *Applied Energy* 216 (2018) 296–310.
- [10] Q. Shi, C.-F. Chen, A. Mammoli, F. Li, Estimating the profile of incentive-based demand response (ibdr) by integrating technical models and social-behavioral factors, *IEEE Transactions on Smart Grid* 11 (1) (2019) 171–183.
- [11] L. Zhao, Z. Yang, W.-J. Lee, The impact of time-of-use (tou) rate structure on consumption patterns of the residential customers, *IEEE Transactions on Industry Applications* 53 (6) (2017) 5130–5138.
- [12] L. Zhang, N. Good, P. Mancarella, Building-to-grid flexibility: Modelling and assessment metrics for residential demand response from heat pump aggregations, *Applied Energy* 233 (2019) 709–723.
- [13] M. H. Imani, P. Niknejad, M. Barzegaran, The impact of customers' participation level and various incentive values on implementing emergency demand response program in microgrid operation, *International Journal of Electrical Power & Energy Systems* 96 (2018) 114–125.
- [14] M. H. Amini, S. Talari, H. Arasteh, N. Mahmoudi, M. Kazemi, A. Abdollahi, V. Bhattacharjee, M. Shafie-Khah, P. Siano, J. P. Catalão, Demand response in future power networks: panorama and state-of-the-art, in: *Sustainable interdependent networks II*, Springer, 2019, pp. 167–191.
- [15] A. Dadkhah, B. Vahidi, On the network economic, technical and reliability characteristics improvement through demand-response implementation considering consumers' behaviour, *IET Generation, Transmission & Distribution* 12 (2) (2018) 431–440.
- [16] A. Fattahi, A. Nahavandi, M. Jokarzadeh, A comprehensive reserve allocation method in a micro-grid considering renewable generation intermittency and demand side participation, *Energy* 155 (2018) 678–689.
- [17] A. Nikoobakht, J. Aghaei, M. Mardaneh, T. Niknam, V. Vahidiniasab, Moving beyond the optimal transmission switching: stochastic linearised scuc for the integration of wind power generation and equipment failures uncertainties, *IET Generation, Transmission & Distribution* 12 (15) (2017) 3780–3792.
- [18] A. Nikoobakht, M. Mardaneh, J. Aghaei, V. Guerrero-Mestre, J. Contreras, Flexible power system operation accommodating uncertain wind power generation using transmission topology control: an improved linearised ac scuc model, *IET Generation, Transmission & Distribution* 11 (1) (2017) 142–153.
- [19] B. Zeng, G. Wu, J. Wang, J. Zhang, M. Zeng, Impact of behavior-driven demand response on supply adequacy in smart distribution systems, *Applied Energy* 202 (2017) 125–137.
- [20] K. Kopsidas, M. Abogaleela, Utilizing demand response to improve network reliability and ageing resilience, *IEEE Transactions on Power Systems* 34 (3) (2018) 2216–2227.
- [21] E. Heydarian-Forushani, M. E. H. Golshan, M. Shafie-khah, P. Siano, Optimal operation of emerging flexible resources considering sub-hourly flexible ramp product, *IEEE Transactions on Sustainable Energy* 9 (2) (2017) 916–929.
- [22] X. Dai, Y. Wang, S. Yang, K. Zhang, Igdtd-based economic dispatch considering the uncertainty of wind and demand response, *IET Renewable Power Generation* 13 (6) (2018) 856–866.
- [23] M. Ahrabi, M. Abedi, H. Nafisi, M. A. Mirzaei, B. Mohammadi-Ivatloo, M. Marzband, Evaluating the effect of electric vehicle parking lots in transmission-constrained ac unit commitment under a hybrid igdt-stochastic approach, *International Journal of Electrical Power & Energy Systems* 125 (2021) 106546.
- [24] M. Vahedipour-Dahraei, H. R. Najafi, A. Anvari-Moghaddam, J. M. Guerrero, Security-constrained unit commitment in ac microgrids considering stochastic price-based demand response and renewable generation, *International Transactions on Electrical Energy Systems* 28 (9) (2018) e2596.
- [25] M. Vahedipour-Dahraie, H. Rashidizadeh-Kermani, A. Anvari-Moghaddam, P. Siano, Risk-averse probabilistic framework for scheduling of virtual power plants considering demand response and uncertainties, *International Journal of Electrical Power & Energy Systems* 121 (2020) 106126.
- [26] C. Duan, L. Jiang, W. Fang, J. Liu, Data-driven affinely adjustable distributionally robust unit commitment, *IEEE Transactions on Power Systems* 33 (2) (2017) 1385–1398.
- [27] Y. Du, Y. Li, C. Duan, H. B. Gooi, L. Jiang, Adjustable uncertainty set constrained unit commitment with operation risk reduced through demand response, *IEEE Transactions on Industrial Informatics* 17 (2) (2020) 1154–1165.
- [28] K. Bruninx, E. Delarue, Endogenous probabilistic reserve sizing and allocation in unit commitment models: Cost-effective, reliable, and fast, *IEEE Transactions on Power Systems* 32 (4) (2016) 2593–2603.
- [29] M. A. Mirzaei, A. S. Yazdankhah, B. Mohammadi-Ivatloo,

- Stochastic security-constrained operation of wind and hydrogen energy storage systems integrated with price-based demand response, *International Journal of Hydrogen Energy* 44 (27) (2019) 14217–14227.
- [30] A. A. Salimi, A. Karimi, Y. Noorizadeh, Simultaneous operation of wind and pumped storage hydropower plants in a linearized security-constrained unit commitment model for high wind energy penetration, *Journal of Energy Storage* 22 (2019) 318–330.
- [31] M. Rahmani, S. H. Hosseinian, M. Abedi, Stochastic two-stage reliability-based security constrained unit commitment in smart grid environment, *Sustainable Energy, Grids and Networks* 22 (2020) 100348.
- [32] S. M. Mousavi-Taghiabadi, M. Sedighzadeh, M. Zangiabadi, A. S. Fini, Integration of wind generation uncertainties into frequency dynamic constrained unit commitment considering reserve and plug in electric vehicles, *Journal of Cleaner Production* 276 (2020) 124272.
- [33] G. Li, Z. Bie, H. Xie, Y. Lin, Customer satisfaction based reliability evaluation of active distribution networks, *Applied Energy* 162 (2016) 1571–1578.
- [34] I. Ismael, M. Saeed, S. Kaddah, S. Abdelkader, Demand response for indirect load control in smart grid using novel price modification algorithm, *IET Renewable Power Generation* 13 (6) (2018) 877–886.
- [35] S. Nan, M. Zhou, G. Li, Optimal residential community demand response scheduling in smart grid, *Applied Energy* 210 (2018) 1280–1289.
- [36] T. Pamulapati, R. Mallipeddi, M. Lee, Multi-objective home appliance scheduling with implicit and interactive user satisfaction modelling, *Applied Energy* 267 (2020) 114690.
- [37] M. Vellei, J. Le Dréau, A novel model for evaluating dynamic thermal comfort under demand response events, *Building and Environment* 160 (2019) 106215.
- [38] A. Dadkhah, B. Vahidi, M. Shafie-khah, J. P. Catalão, Power system flexibility improvement with a focus on demand response and wind power variability, *IET Renewable Power Generation* 14 (6) (2020) 1095–1103.
- [39] N. Good, Using behavioural economic theory in modelling of demand response, *Applied energy* 239 (2019) 107–116.
- [40] M. Nicolson, G. Huebner, D. Shipworth, Are consumers willing to switch to smart time of use electricity tariffs? the importance of loss-aversion and electric vehicle ownership, *Energy research & social science* 23 (2017) 82–96.
- [41] H. A. Aalami, H. Pashaei-Didani, S. Nojavan, Deriving nonlinear models for incentive-based demand response programs, *International Journal of Electrical Power & Energy Systems* 106 (2019) 223–231.
- [42] C. Grigg, P. Wong, P. Albrecht, R. Allan, M. Bhavaraju, R. Billinton, Q. Chen, C. Fong, S. Haddad, S. Kuruganty, et al., The IEEE reliability test system-1996. a report prepared by the reliability test system task force of the application of probability methods subcommittee, *IEEE Transactions on power systems* 14 (3) (1999) 1010–1020.
- [43] Z. Bie, H. Xie, G. Hu, G. Li, Optimal scheduling of power systems considering demand response, *Journal of Modern Power Systems and Clean Energy* 4 (2) (2016) 180–187.
- [44] J. Aghaei, M.-I. Alizadeh, P. Siano, A. Heidari, Contribution of emergency demand response programs in power system reliability, *Energy* 103 (2016) 688–696.
- [45] X. Liu, M. Shahidehpour, Z. Li, X. Liu, Y. Cao, Z. Bie, Microgrids for enhancing the power grid resilience in extreme conditions, *IEEE Transactions on Smart Grid* 8 (2) (2016) 589–597.
- [46] E. Heydarian-Forushani, M. E. H. Golshan, P. Siano, Evaluating the operational flexibility of generation mixture with an innovative techno-economic measure, *IEEE Transactions on Power Systems* 33 (2) (2017) 2205–2218.
- [47] H. Karimi, S. Jadid, H. Saboori, Multi-objective bi-level optimization to design real-time pricing for demand response programs in retail markets, *IET Generation, Transmission & Distribution* 13 (8) (2018) 1287–1296.