



Vaasan yliopisto
UNIVERSITY OF VAASA

OSUVA Open
Science

This is a self-archived – parallel published version of this article in the publication archive of the University of Vaasa. It might differ from the original.

Hybrid planning of distributed generation and distribution automation to improve reliability and operation indices

Author(s): Pirouzi, Sasan; Zaghian, Masoud; Aghaei, Jamshid; Chabok, Hossein; Abbasi, Mohsen; Norouzi, Mohammadali; Shafie-khah, Miadreza; Catalao, Joao P.S.

Title: Hybrid planning of distributed generation and distribution automation to improve reliability and operation indices

Year: 2022

Version: Accepted manuscript

Copyright ©2022 Elsevier. This manuscript version is made available under the Creative Commons Attribution–NonCommercial–NoDerivatives 4.0 International (CC BY–NC–ND 4.0) license, <https://creativecommons.org/licenses/by-nc-nd/4.0/>

Please cite the original version:

Pirouzi, S., Zaghian, M., Aghaei, J., Chabok, H., Abbasi, M., Norouzi, M., Shafie-khah, M. & Catalao, J.P.S. (2022). Hybrid planning of distributed generation and distribution automation to improve reliability and operation indices. *International Journal of Electrical Power & Energy Systems* 135, 107540. <https://doi.org/10.1016/j.ijepes.2021.107540>

Hybrid Planning of Distributed Generation and Distribution Automation to Improve Reliability and Operation Indices

Sasan Pirouzi¹, Masoud Zaghian¹, Jamshid Aghaei^{2,3}, Hossein Chabok², Mohsen Abbasi¹,
Mohammadali Norouzi², Miadreza Shafie-khah⁴, and João P.S. Catalão⁵

¹ Power System Group, Islamic Azad University, Semirom, Iran

² Department of Electrical and Electronics Engineering, Shiraz University of Technology, Shiraz, Iran

³ School of Energy Systems, Lappeenranta-Lahti University of Technology (LUT), Lappeenranta, Finland

⁴ School of Technology and Innovations, University of Vaasa, Vaasa, Finland

⁵ Faculty of Engineering of University of Porto and INESC TEC, 4200-465 Porto, Portugal

Abstract: This paper intends to give an effective hybrid planning of distributed generation and distribution automation in distribution networks aiming to improve the reliability and operation indices. The distribution automation platform consists of automatic voltage and VAR control and automatic fault management systems. The objective function minimizes the sum of the expected daily investment, operation, energy loss and reliability costs. The scheme is constrained by linearized AC optimal power flow equations and planning model of sources and distribution automation. A stochastic programming approach is also implemented in this paper based on a hybrid method of Monte Carlo simulation and simultaneous backward method to model uncertainty parameters of the understudy model including load, energy price and availability of network equipment. Finally, the proposed strategy is implemented on an IEEE 69-bus radial distribution network and different case studies are presented to demonstrate the economic and technical benefits of the investigated model. By allocating the optimal places for sources and distribution automation across the distribution network and extracting the optimal performance, the proposed scheme can simultaneously enhance economic, operation, and reliability indices in the distribution system compared to power flow studies.

Keywords: Distribution automation; Distributed generation; Operation indices; Mixed integer linear programming; Reliable planning.

Nomenclature

1) Indices and Sets

$(n,j), t, s, l, k$	Indices of bus, time, scenario, linearization segments of voltage term and circular plane, respectively
$\Omega_n, \Omega_t, \Omega_s, \Omega_l, \Omega_k$	Sets of bus, time, scenario, linearization segments of voltage term and circular plane, respectively
n_l, n_k	Total number of linearization segments for voltage term and circular plane, respectively
Ref	Slack bus

2) Parameters

A^L	Bus incidence matrix
C^{dg}, C^c, C^p	Daily investment cost for distributed generation (DG), capacitor bank and protection device
$\bar{C}^{dg}, \bar{C}^c, \bar{C}^p$	Investment budget of DG, capacitor bank and protection device
g, b	Line conductance and susceptance
M	Large constant, 10^6
\bar{N}	Maximum total number of switch operation
N_{bus}	Total number of network buses
P^D, Q^D	Active and reactive load
\bar{S}^C	Maximum capacity of capacitor bank in per-unit (p.u)
\bar{S}^{DG}	Maximum capacity of DG in p.u
\bar{S}^S, \bar{S}^L	Maximum loading of distribution station and line in p.u, respectively
\underline{V}, \bar{V}	Minimum and maximum voltage magnitude in p.u, respectively
$VOLL$	Value of lost load in \$/MWh
Y	Planning year
λ	Energy price in \$/MWh
ρ^{dg}	Fuel price in \$/MWh
π	Probability occurrence
$\Delta\alpha$	Angle deviation

3) Variables

P^{DG}, Q^{DG}	Active and reactive power of DG in p.u
P^L, Q^L	Active and reactive power flow in p.u
P^{LNS}	Active power not supplied in p.u
Q^C	Reactive power of capacitor bank in p.u
P^S, Q^S	Active and reactive power of distribution station in p.u
$V, \Delta V, \delta$	Magnitude and deviation of voltage (p.u), and voltage angle (in rad)
x^{dg}, x^c, x^p	Binary variables linked to investment state of DG, capacitor bank and protection device
y^p	Binary variables linked to state of protection device

1. Introduction

1.1. Motivation

For the last few years, the distributed generations (DGs) have been vastly investigated in many literatures and researches have put the spot light on suitability of such local energy sources as an effective option to improve the operation indices such as voltage profile, network power loss [1] and reliability indices, namely expected energy not supplied (EENS) [2] within the distribution network. Also the implementation of the distribution automation (DA) platform has improved both the reliability and operation of the distribution networks [3].

The DA includes automatic voltage and VAR control (AVVC) and automatic fault management (AFM) systems [3], which provides the chance of using the capacitor bank, static VAR compensator (SVC) and other volt/var control devices for the AVVC system to regulate/inject voltage/reactive power in the distribution network [4]. Also, the AFM contains protection switches, tie lines or switches, etc. to improve the network's protective ability and system reliability during faults as unpredictable, unavoidable and menacing situations [5]. However, the proposed superiorities are heavily linked to the optimal locations of DGs and DA systems in the distribution network and will be obtained once a proper planning approach is carried out over the DGs and DA systems within the distribution network.

1.2. Literature review

As mentioned, DG or DA planning approach was the core of attention of many research works. In this regard, authors of [1] investigate the impacts of optimal planning DG on the distribution network resiliency. Also, the capability of DG and storage in improving operation and resiliency situation of smart grid has been expressed in

[2]. Accordingly, obtaining optimal locations and size for DGs can improve technical indices of network such as energy loss, voltage profile and EENS. In [6], the optimal location and size of DGs in the microgrid (MG) has been assessed using a master–slave approach. In the studied model, the planning problem has been solved in the master problem and the operation model has been considered in the slave part.

The optimal allocation of wind energy system in MG has been formulated in [7] and zonotope-based set-theoretic technique has been employed to model wind variability. In [8], the DG planning model in the distribution network has been presented based on semi-invariant probabilistic power flow approach. A robust planning model of renewable energy sources, energy storage system, and demand response in the distribution network has been expressed in [9] where the authors have represented their model based on the information gap decision theory.

The authors in [10] have proposed a planning model for DG and fault current limiter in the distribution system to improve the operation and protection indices. Generally speaking, the DA system consists of AVCC and AFM, where AVCC system is used to improve the system operation variables such as voltage and power factor [4], while the AFM improves the protection indices during fault conditions [5]. In this regard, in [11], the AFM system has been utilized to obtain the optimal placement of sectionalizing or tie-switches with the goal of achieving high reliability in the radial distribution networks.

The optimal allocation model of DA has been presented in [12], and the DA planning model coupled with distribution system expansion planning method has been addressed in [13] to enhance the reliability of the network. In [14], the location of protective devices has been obtained in a distribution network to improve reliability indices. Moreover, the AVCC and AFM approaches have also been considered in [15], where the authors have provided a joint model of network reconfiguration and capacitor placement.

1.3. Contributions

According to the above explanations, simultaneous hybrid planning of DGs and DA systems to improve the economic, operation and reliability indices has not been addressed by researchers, whilst it is forecasted that the proposed credits can be improved by means of carrying out a proper hybrid planning approach over the DGs and DA systems in the distribution network which will lead to a lower cost procedure compared to the separated planning of the DGs and DA.

Also, most researches propose the evolutionary algorithms to solve the planning problem of network devices; however, these algorithms follow the rule of random phenomena and are basically iteration-based

numerical methods. Hence, these approaches cause high calculation time and the global optimality of the solutions cannot be guaranteed in these methods. To overcome these challenges, this paper presents a hybrid planning model of DGs and DAs in the distribution network constrained to the system reliability and operation (see Fig. 1).

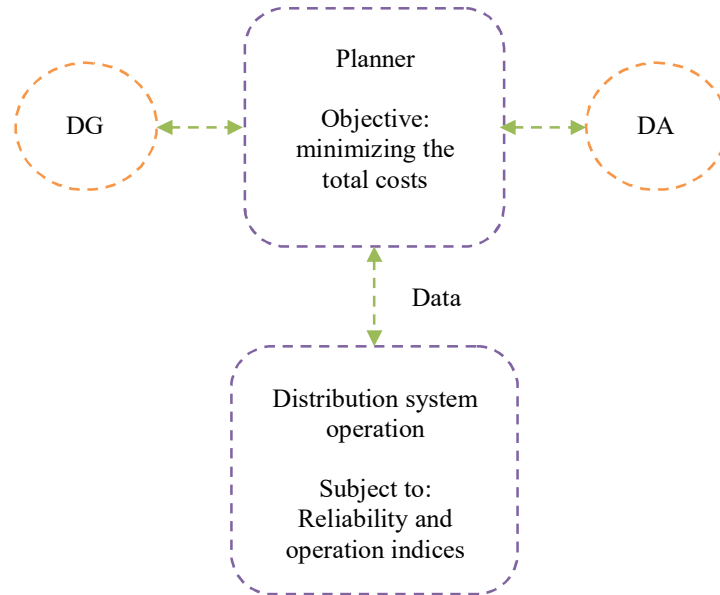

Fig. 1: The studied hybrid planning approach of DGs and DAs in the distribution network

This problem minimizes the expected daily investment, operation, energy loss and reliability costs subject to AC optimal power flow equations, DGs and DAs planning constraints and reconfiguration limits. It should be mentioned that the provided strategy contains the mixed-integer nonlinear programming (MINLP) model, which is converted to the mixed-integer linear programming (MILP) model to obtain guaranteed optimal solution at the low computational time. To make the model more realistic, an effective stochastic programming approach using scenario-based method is employed to model the uncertainties associated with load, energy price and the availability of network equipment, where the scenario generation model is based on the Monte Carlo simulation (MCS) method and scenario reduction approach follows the simultaneous backward method (SBM).

The novel contributions of this paper are as follows:

- Introducing an effective hybrid reliable planning model of DGs and DA in the distribution network, seeking to simultaneously improve the economic, reliability and operation indices.
- Representing a linearization approach for the proposed planning model aiming to improve the calculation speed and solution accuracy.
- Representing a hybrid stochastic programming model based on MCS and SBM methods to model the uncertainties associated with the load, energy price and availability of network equipment.

1.4. Paper organization

The rest of the paper is organized as follows: Section 2 describes the proposed stochastic planning model of DGs and DA systems as MINLP and MILP methods. Section 3 demonstrates numerical simulations and the main conclusion and contributions of the proposed work are highlighted in Section 4.

2. The proposed problem formulation

2.1. Original model

The proposed model of DG and DA planning in the distribution network is represented. The main objective function is formed in such a way that it minimizes the summation of investment, operation, energy loss and reliability costs.

Therefore, the proposed model is represented as follows:

$$\begin{aligned}
 \min \quad & \underbrace{\frac{1}{Y \times 365} \sum_{n \in \Omega_n} C_n^{dg} x_n^{dg}}_{\text{Daily DGs' investment cost}} + \underbrace{\frac{1}{Y \times 365} \sum_{n \in \Omega_n} C_n^c x_n^c + \sum_{n,j \in \Omega_n} C_{n,j}^p x_{n,j}^p}_{\text{Daily DAs' investment cost}} + \\
 & \underbrace{\sum_{s \in \Omega_s} \pi_s \sum_{t \in \Omega_t} \sum_{n \in \Omega_n} (\lambda_{t,s} P_{ref,t,s}^S + \rho_n^{dg} P_{n,t,s}^{DG})}_{\text{Daily operation cost}} + \\
 & \underbrace{\sum_{s \in \Omega_s} \pi_s \sum_{t \in \Omega_t} \sum_{n \in \Omega_n} \lambda_{t,s} (P_{ref,t,s}^S + P_{n,t,s}^{DG} - P_{n,t,s}^D)}_{\text{Daily energy loss cost}} + \\
 & \underbrace{VOLL \times \sum_{s \in \Omega_s} \pi_s \sum_{t \in \Omega_t} \sum_{n \in \Omega_n} P_{n,t,s}^{LNS}}_{\text{Daily reliability cost}}
 \end{aligned} \tag{1}$$

subject to:

$$\sum_{n \in \Omega_n} C_n^{dg} x_n^{dg} \leq \bar{C}^{dg} \tag{2}$$

$$\sum_{n \in \Omega_n} C_n^c x_n^c \leq \bar{C}^c \tag{3}$$

$$\sum_{n,j \in \Omega_n} C_{n,j}^p x_{n,j}^p \leq \bar{C}^p \tag{4}$$

$$P_{n,t,s}^{LNS} + P_{n,t,s}^S + P_{n,t,s}^{DG} - \sum_{j \in \Omega_n} A_{n,j}^L P_{n,j,t,s}^L = P_{n,t,s}^D \quad \forall n,t,s \tag{5}$$

$$Q_{n,t,s}^S + Q_{n,t,s}^{DG} + Q_{n,t,s}^C - \sum_{j \in \Omega_n} A_{n,j}^L Q_{n,j,t,s}^L = Q_{n,t,s}^D \quad \forall n,t,s \tag{6}$$

$$P_{n,j,t,s}^L = \left\{ g_{n,j} (V_{n,t,s})^2 - V_{n,t,s} V_{j,t,s} \left\{ g_{n,j} \cos(\theta_{n,t,s} - \theta_{j,t,s}) + b_{n,j} \sin(\theta_{n,t,s} - \theta_{j,t,s}) \right\} \right\} y_{n,j,t}^p \quad \forall n,j,t,s \tag{7}$$

$$Q_{n,j,t,s}^L = \left\{ -b_{n,j} (V_{n,t,s})^2 + V_{n,t,s} V_{j,t,s} \left\{ b_{n,j} \cos(\theta_{n,t,s} - \theta_{j,t,s}) - g_{n,j} \sin(\theta_{n,t,s} - \theta_{j,t,s}) \right\} \right\} y_{n,j,t}^p \quad \forall n, j, t, s \quad (8)$$

$$\theta_{n,t,s} = 0 \quad \forall n = ref, t, s \quad (9)$$

$$\sqrt{(P_{n,j,t,s}^L)^2 + (Q_{n,j,t,s}^L)^2} \leq \bar{S}_{n,j}^L \quad \forall n, j, t, s \quad (10)$$

$$\sqrt{(P_{n,t,s}^S)^2 + (Q_{n,t,s}^S)^2} \leq \bar{S}_n^S \quad \forall n = ref, t, s \quad (11)$$

$$\underline{V}_n \leq V_{n,t,s} \leq \bar{V}_n \quad \forall n, t, s \quad (12)$$

$$\sqrt{(P_{n,t,s}^{DG})^2 + (Q_{n,t,s}^{DG})^2} \leq \bar{S}_n^{DG} x_n^{dg} \quad \forall n, t, s \quad (13)$$

$$Q_{n,t,s}^C = \bar{S}_n^C x_n^c \quad \forall n, t, s \quad (14)$$

$$y_{n,j,t}^p \leq x_{n,j}^p \quad \forall n, j, t \quad (15)$$

$$\sum_{t \in \Omega_t} y_{n,j,t}^p \leq \bar{N}_{n,j} \quad \forall t \quad (16)$$

$$\sum_{n,j \in \Omega_n} y_{n,j,t}^p \leq N_{bus} - 1 \quad \forall t \quad (17)$$

$$0 \leq P_{n,t,s}^{LNS} \leq P_{n,t,s}^D \quad \forall n, t, s \quad (18)$$

The main objective function is formulated in (1). As can be seen it is made up of four parts which will be discussed in detail. First part refers to the daily DGs and DAs investment costs, where DA contains AVVC and AFM in this model. The daily operation and energy loss costs expressed in second and third parts of equation (1), respectively [16]. Noted that the energy loss is equal to the difference between generation and consumption energies in this equation. Finally, the daily reliability cost that is based on expected energy not supplied (EENS) and value of lost load (VOLL) is presented in the last part of equation (1) [17]. Constraints (2)-(4) refer to the investment budget for installation of DG, AVVC and AFM, each presenting the maximum investable budget on installing the mentioned equipment in the distribution network. In addition, the AC power flow equations are formulated in (5)-(9) [18]. Equations (5)-(6) are the active and reactive power balance equations which is mandatory for supplying the loads of the studied network [19]. Equations (7)-(8) define the injected active and reactive power through the lines, respectively [20] and voltage angle value of the slack bus is expressed by equation (9) [21]. System operation limits including distribution lines, station capacity limits and voltage limitation constraints are formulated in (10)-(12). Hence, values of these variables are zero in other buses [21]. DG capacity limit and its planning model is presented in constraint (13). In this regard, bus n is suitable location for DG installation if x_n^{dg} in this bus is equal to 1, otherwise, $x_n^{dg} = 0$ [6]. Also, DA planning model is presented in

(14) and (15), where equations (14) and (15) refers to the AVVC and AFM system planning method, respectively [3]. It is noteworthy that the AVVC system is assumed to include capacitor bank and AFM system containing protection switches such as over current relays. In this equations, AVVC or AFM location is acceptable based on the proposed objective function and if $x^c/x^p = 1$, otherwise, $x^c/x^p = 0$. The reconfiguration model is formulated in (16) and (17) which are the total number limit of protection switch operation and radial structure constraint of the distribution network, respectively [22]. It should be noted that the opened/closed status of the protection switch (y^p) depends on the distribution system operator (DSO)'s demand that is formulated in equation (1). Hence, the reconfiguration model is coordinated by DSO using constraints (7) and (8). Finally, the reliability constraint is modeled in (18) that is referred to the limitation of load not supplied (LNS) index in each bus [18].

Note that two types of planning approach can be considered for the proposed design including: static planning and dynamic planning. In the static programming, the location and size of the equipment to be installed are generally specified. But, in the dynamic planning, the location and size of the equipment that can be installed plus the time of its installation is obtained. In this paper, the static planning is considered. Accordingly, the binary variable x does not have a time subscript. In other words, since the installation cost of DGs and DAs in the first year is cheaper than in the next 10 years, they are expected to be installed in the first year. Therefore, it is crystal clear that the static programming model will have shorter computational time due to its less complexity with respect to the dynamic planning while it has fewer binary variables as well as fewer logical constraints than the dynamic model. It also has simpler modeling and good accuracy.

2.2. The proposed MILP model

The proposed original problem (equations (1)-(18)) is a non-convex MINLP model since it contains non-linear constraints (7), (8), (10), (11), (13) and non-convex equations (4)-(5) [23], and binary variables x^{dg} , x^c , x^p and y^p . This model can be solved by numerical methods such as Newton Raphson method or evolutionary algorithms which causes low calculation speed [24]. Also, this model can be achieved local optimal solution in the best situation arising from non-convex equations [25]. To cope with these issues, the proposed original method is transformed into the MILP model to obtain more optimal solution in comparison with non-linear model [26] in a low time consuming manner [27] with high accuracy [28]. The details of the proposed linearization approaches are expressed as follows:

- 1- *The linearization model of AC power flow equations:* it should be noted that in this paper, similar to the one represented in [24], the difference between voltage angles of two adjacent bus, connected through a line is less than 6 degree or 0.105 radian based. Accordingly, the terms $\cos(\theta_{n,t,s} - \theta_{j,t,s})$ and $\sin(\theta_{n,t,s} - \theta_{j,t,s})$ in equations (4) and (5) can be substituted with 1 and $(\theta_{n,t,s} - \theta_{j,t,s})$, respectively. Also, the voltage magnitude can be formulated as $\underline{V} + \sum_{l \in \Omega_l} \Delta V_l$ based on the conventional piecewise linearization method [25]. Hence, the terms V^2 and $V_n V_j$ can be expressed as $(\underline{V})^2 + \sum_{l \in \Omega_l} m_l \Delta V_l$ and $(\underline{V})^2 + \underline{V} \cdot \sum_{l \in \Omega_l} (\Delta V_{n,l} + \Delta V_{j,l})$, respectively. In these equations, m is line slop, ΔV is voltage deviation, set of linearization segment (Ω_l) is equal to $\{1, 2, \dots, n_l\}$ and n_l is the total number of linearization segments of voltage term. In this method, ΔV^2 , $\Delta V \times (\theta_n - \theta_j)$ and $\Delta V_n \Delta V_j$ have very small values; hence, these terms are neglected (removed) in linear equations related to constraints (7) and (8). In addition, the right-hand side of equations (4) and (5) is the multiplication of binary (z) and continuous (b) variables, which can be represented as $a = b \times z$. According to this equation, $a = b$ if $z = 1$, and $a = 0$ if $z = 0$. Therefore, the proposed definition and the aforementioned equations can be linearized using Big M approach [18]. In this approach, the linear equations of $-M \times (1 - z) \leq a - b \leq M \times (1 - z)$ and $-M \times z \leq a \leq M \times z$ can replace the nonlinear equation $a = b \times z$, where M is a large constant, e.g. 10^6 .
- 2- *The linearization model of circular inequality:* Constraints (10), (11) and (13) can be considered as circular plane which is able to be approximated as polygon plane as shown in Fig. 2. Based on this figure, each edge of the polygon is a straight line and its equation can be achieved from the tangent of an angle in the circular area at a specific point as depicted in Fig. 2 [25]. More details regarding the proposed technique can be found in [25].

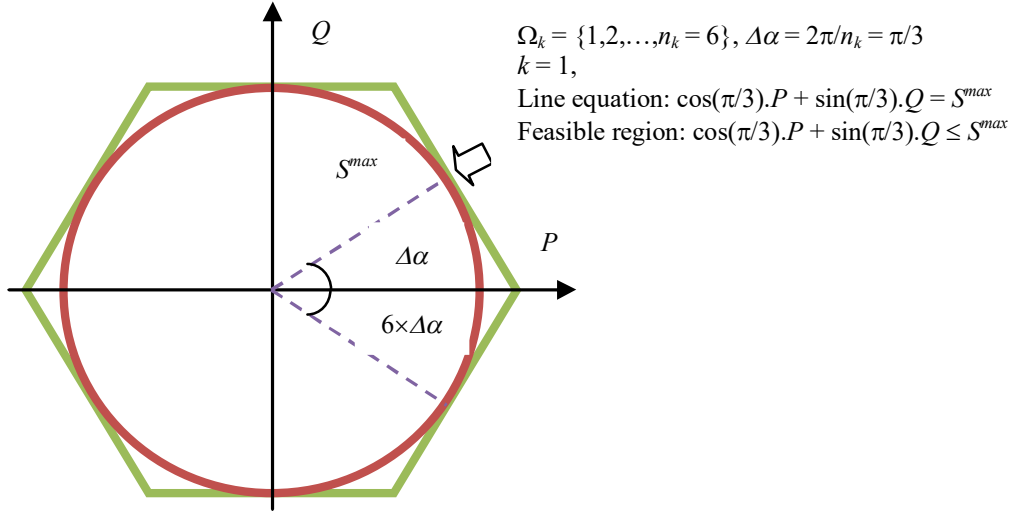

Fig. 2 The linearization approach for circular plane [25]

Therefore, the proposed MILP model of the DG and DA planning in the distribution network can be written as follows:

$$\begin{aligned}
 \min \quad & \underbrace{\frac{1}{Y \times 365} \sum_{n \in \Omega_n} C_n^{dg} x_n^{dg}}_{\text{Daily DGs investment cost}} + \underbrace{\frac{1}{Y \times 365} \sum_{n \in \Omega_n} C_n^c x_n^c + \sum_{n, j \in \Omega_n} C_{n, j}^p x_{n, j}^p}_{\text{Daily DAs investment cost}} + \\
 & \underbrace{\sum_{s \in \Omega_s} \pi_s \sum_{t \in \Omega_t} \sum_{n \in \Omega_n} (\lambda_{t, s} P_{ref, t, s}^S + \rho_n^{dg} P_{n, t, s}^{DG})}_{\text{Daily operation cost}} + \\
 & \underbrace{\sum_{s \in \Omega_s} \pi_s \sum_{t \in \Omega_t} \sum_{n \in \Omega_n} \lambda_{t, s} (P_{ref, t, s}^S + P_{n, t, s}^{DG} - P_{n, t, s}^D)}_{\text{Daily energy loss cost}} + \\
 & \underbrace{VOLL \times \sum_{s \in \Omega_s} \pi_s \sum_{t \in \Omega_t} \sum_{n \in \Omega_n} P_{n, t, s}^{LNS}}_{\text{Daily reliability cost}}
 \end{aligned} \tag{19}$$

subject to:

$$-M \cdot (1 - y_{n, j, t}^p) \leq P_{n, j, t, s}^L - \left\{ g_{n, j} \left(\sum_{l \in \varphi_l} (m_l - \underline{V}) \Delta V_{n, t, s, l} - \underline{V} \cdot \Delta V_{j, t, s, l} \right) - (\underline{V})^2 b_{n, j} (\theta_{n, t, s} - \theta_{j, t, s}) \right\} \leq M \cdot (1 - y_{n, j, t}^p) \quad \forall n, j, t, s \tag{20}$$

$$-M \cdot (1 - y_{n, j, t}^p) \leq Q_{n, j, t, s}^L - \left\{ -b_{n, j} \left(\sum_{l \in \varphi_l} (m_l - \underline{V}) \Delta V_{n, t, s, l} - \underline{V} \cdot \Delta V_{j, t, s, l} \right) - (\underline{V})^2 g_{n, j} (\theta_{n, t, s} - \theta_{j, t, s}) \right\} \leq M \cdot (1 - y_{n, j, t}^p) \quad \forall n, j, t, s \tag{21}$$

$$0 \leq \Delta V_{n, t, s, l} \leq \frac{\bar{V}_n - \underline{V}_n}{n_k} \quad \forall n, t, s, l \tag{22}$$

$$P_{n, j, t, s}^L \cos(k \cdot \Delta \alpha) + Q_{n, j, t, s}^L \sin(k \cdot \Delta \alpha) \leq \bar{S}_{n, j}^L y_{n, j, t}^p \quad \forall n, j, t, s, k \tag{23}$$

$$P_{n,t,s}^S \cos(k.\Delta\alpha) + Q_{n,t,s}^S \sin(k.\Delta\alpha) \leq \bar{S}_n^S \quad \forall n = ref, t, s, k \quad (24)$$

$$P_{n,t,s}^{DG} \cos(k.\Delta\alpha) + Q_{n,t,s}^{DG} \sin(k.\Delta\alpha) \leq \bar{S}_n^{DG} x_n^{dg} \quad \forall n, t, s, k \quad (25)$$

$$\text{Constraints (2)-(6), (9), and (14)-(18)} \quad (26)$$

In the new model, objective function (19) is remained unchanged due to its liner format, and is equal to the one represented before using equation (1). Also, based on the proposed first linearization method, the approximately linearized format of constraints (7), (8) and (12) is written as (20)-(22), respectively. Moreover, the linear formats of the capacity limit of distribution lines, station and DG are obtained using the second linearization technique and expressed in (23)-(25). Noted that according to Big M method [18], y^p is created in distribution line capacity limit based on (23). Finally, constraint (26) refers to the linear equations of the proposed MILP model, and remained unchanged the same as the ones represented in original DG and DA planning formulation.

2.3. Stochastic programming to DG and DA planning model

In the proposed planning model, active P^D and reactive Q^D load, energy price λ , and availability of network equipment are uncertain parameters of the model, which are ignorable if it is intended to provide an effective model. Hence, an appropriate stochastic programming method based on hybrid method of Mont Carlo simulation (MCS) and simultaneous backward method (SBM) is used to model these uncertain parameters. Firstly, the MCS generates a large number of scenario samples. In each scenario, initially, values of P^D , Q^D , and λ are determined based on their average and standard deviation values. Also, in each scenario, the amount of the last uncertainty parameter mentioned is determined based on the forced outage rates (FORs) of this equipment. Then, in each scenario, the probability of the selected value for the first three uncertainty parameters is calculated from the normal probability distribution function (PDF) [22]. The probability value of the last uncertainty parameter is determined based on Bernoulli PDF [18]. In the next step, the probability of each scenario (π^l) is calculated by multiplying the probability of the uncertainty parameters mentioned in this scenario. Since, the MCS has generated a large number of scenarios, and their application leads to a problem with high computational time, the next step is to use the SBM scenario reduction technique to determine a smaller number of scenarios. In this method, scenarios with maximal distance from each other and with a high probability of occurrence are selected [22]. The formulation of this method is presented in [22]. Finally, the

probability of a scenario occurring after applying the SBM (π) can be found from $\pi_s = \frac{\pi_s^0}{\sum_{s \in \Omega_s} \pi_s^0}$, where Ω_s

represents the set of scenarios resulting from SBM.”

3. Numerical results and discussion

3.1. Case study

The proposed method of DG and DA planning is implemented on the IEEE 69-bus radial distribution network which is shown in Fig. 3 [29]. The basic power and voltage of the network is 1 MVA and 12.66 kV, respectively. Also, minimum and maximum allowed voltage value of the buses are 0.9 and 1.05 p.u., respectively. The lines characteristics and the value of peak load is drawn from [19].

Moreover, it is considered that planning of tie switches or tie lines is related to the AFM, where location of tie lines is shown in Fig. 3 with dashed lines, where resistance, reactance and investment cost of which are 0.0125 p.u, 0.0125 p.u, and 15,000 \$, respectively. Also, AVVC system in this paper is capacitor bank with capacity of 200 kVAr and investment cost of 100,000 \$, which is able to be connected to each bus. In this network, the available DG unit for installation has the capacity of 350 kVA, and investment and operation cost of 525,000 \$ and 20 \$/MWh, respectively, which can be placed on each bus in the network. The investment budget for installing DG, AVVC, and AFM in the mentioned distribution network is \$4,000,000, \$400,000, and \$100,000. The hourly energy price curve is similar to the one represented in [16], which is equal to 16 \$/MWh for period 1:00-7:00, 24 \$/MWh for period 8:00-17:00 and 30 \$/MWh for periods 23:00-24:00 and 18:00-22:00. Finally, VOLL is assumed to be 100 \$/MWh, FOR of network equipment is 1%, and total number of operational switches is 16.

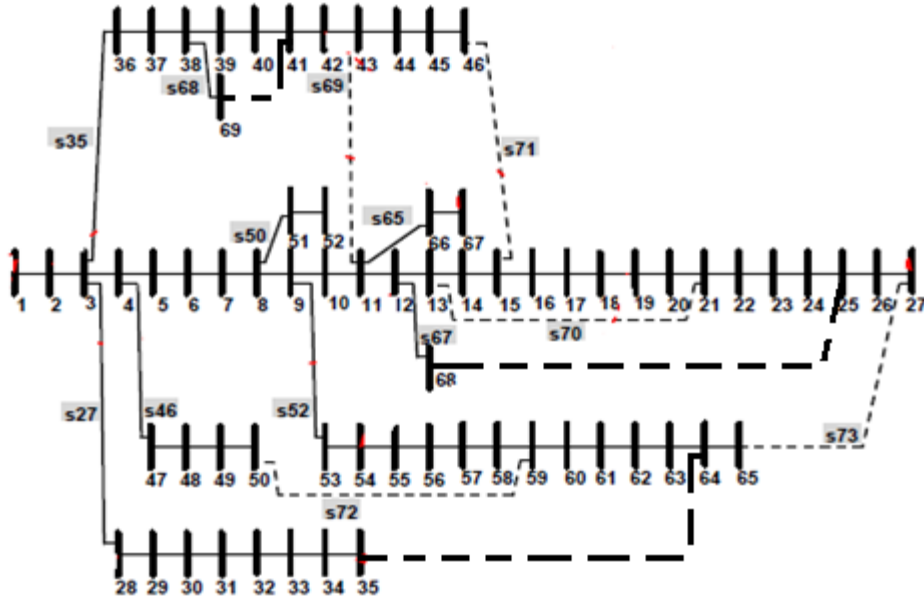

Fig. 3: Illustrative representation of 69-bus radial distribution network [29].

3.2. Results

The proposed strategy is coded in GAMS software and the resulted MINLP and MILP format of the studied model is solved by BONMIN and CPLEX solvers [30]. The MCS produces 1000 scenarios for each uncertain parameter, the mean values of which are based on the data represented in section 3.1 with a standard deviation of 10%. In the next step, the SBM decreases the scenarios to 20 with high probability occurrence.

A) *Investigating the capability of the proposed MILP model:* Table 1 expresses the calculation time, values of the network variables, and objective function value in the proposed MINLP and MILP models with respect to the total number of linearization segments of voltage term and circular plane which are considered 5 and 45, respectively. As it is evident, the MILP model has obtained the optimal solution at low calculation time (97 s) which is a lower value compared to the MINLP method which has been solved with a calculation time of 3018 s. It can be seen that the total computational time has been reduced about 96.8% using the MILP model. Also, the resulted calculation error of the proposed MILP model for different variables is lower in comparison with the original MINLP model as shown in Table 1. Also, the deviation of generated active and reactive power of the MILP model with respect to MINLP model is about 3% and it is almost 0.4% for voltage magnitude and angle. As another point, according to Table 1, the value of the objective function in the MILP model is about 3% less than the MINLP model. Among nonlinear problem solvers, a solver with a more optimal objective function is generally chosen because it is expected to have an optimal point closer to the absolute optimal point. That is, in the proposed problem, a solver with a less objective function is selected, which can extract the linear

approximation model used for the nonlinear model. Therefore, the MINLP model can be replaced with a MILP model leading to a lower calculation time and error. It should be noted, however, that achieving a linear approximation for different equations in accordance with subsection 2.2 for large and complex networks may have different constraints, which require different solutions to be used to overcome these constraints. But in general, the extraction of a linear approximation model for the proposed problem has a very low computational time compared to the nonlinear model of the proposed scheme.

Table 1: Comparison between MINLP and MILP models results

Model	MINLP	MILP	Calculation error (%)
Calculation time (s)	3018	97	96.8
Total daily energy generation (p.u)	54.53	52.96	2.88
Total daily reactive power generation (p.u)	34.21	33.12	3.18
Mean value of voltage magnitude at peak load time (p.u)	0.954	0.951	0.314
Mean value of voltage angle at peak load time (p.u)	- 0.087	-0.08704	0.046
Objective function value (\$) based on Eq. (1)	2960.9	2871.3	3.02

B) *Planning results*: Fig. 4 shows the DG and DA planning results in the 69-bus distribution network using the proposed strategy and based on the MILP format (16)-(23). According to this figure, five tie lines or switches are installed in this network based on the proposed planning method to consolidate/improve the AFM/reliability indices, located between buses (11, 43), (13, 21), (15, 46), (27, 65) and (50, 59). Regarding the AVVC system, three capacitor banks are placed on the end buses of feeders 1-27, 36-46 and 53-65 to improve the voltage profile according to the proposed MILP model. Moreover, seven DGs are installed in buses 12, 19, 50, 60-62 and 64 to improve the reliability and operation indices. Also, it should be noted that the voltage of feeder between buses 53-65 has lower value compared to the other feeders in the network as stated in [16], which is improved in this work and provided in subsection 3.2.C. For this reason, 4 DGs are located in this feeder to improve operation indices. In addition, economical results of the DG and DA planning are expressed in Table 2, which represents the daily expected costs of investment, operation, energy loss and reliability considering the planning horizon (Y) of 10 years. As it is evident, the total investment cost for the DA system within the proposed planning horizon is about 37,500 \$ $((82.2 + 20.5) \times 10 \times 365)$ in the 69-bus distribution network, if it is intended to obtain an optimal situation in terms of reliability and operation indices. However, the total investment cost of the DGs is nearly 3,675,000 \$ throughout the proposed planning horizon in this network. On the flip side and according to Table 2, this strategy will make the daily operation, energy loss and reliability costs to be reduced about 16.3%, 68.8% and 83.6%, respectively compared to the case without DG and DA in the network. Therefore, the total daily cost of the proposed planning model considering DG and DA

is about 2871.3 \$, while it is nearly 4661.5 \$ in case of without DG and DA. This proves that the proposed planning strategy makes the total daily cost to be effectively diminished about 38.4 % and obviously indicates the authenticity of the studied procedure.

Note that according to Eq. (1), the proposed scheme has four terms. The first cost term is paid for the installation of DG and DA in the distribution network (first line of Eq. (1)). The second term is paid for the energy consumed by the upstream grid (second line of Eq. (1), second term) and DGs (second line of Eq. (1), second term). The cost of energy losses on the planning horizon should be paid as in the third line of Eq. (1). The cost of outage or reliability in proportion to the fourth line of Eq. (1) is also one of the costs of the proposed plan. In the case of studies that do not consider the installation of DG and DA, there are three costs of energy purchase, energy loss and reliability in the proposed plan. Of these, studies based on Table 2 have a total daily cost of \$4661.5. However, the installation of DG and DA reduces the daily costs of reliability, energy losses and energy purchases compared to the previous study (excluding the installation of DG and DA), so that the sum of these costs in addition to the installation cost, according to Table 2, is \$2871.3, which is about 38.4% less than the previous case.

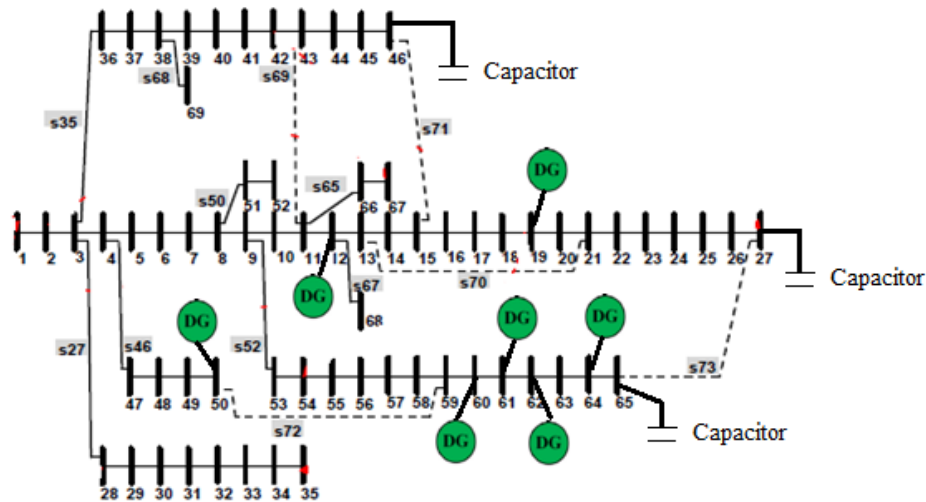

Fig. 4: DG and DA planning results in the IEEE 69-bus distribution network [16].

Table 2: Economic results of DG and DA planning strategy in the distribution networks

	Daily expected cost of	Value (\$)	Deviation
Investment	DG	1006.8	-
	AVVC	82.2	-
	AFM	20.5	-
Operation	Without DG and DA	1464.2	$(1464.2 - 1225.8)/1464.2 = 16.3 \%$
	With DG and DA	1225.8	
Energy loss	Without DG and DA	79.6	$(79.6 - 24.8)/79.6 = 68.8 \%$
	With DG and DA	24.8	
Reliability	Without DG and DA	3117.7	$(3117.7 - 511.2)/3117.7 = 83.6 \%$
	With DG and DA	511.2	
Total	Without DG and DA	4661.5	$(4661.5 - 2871.3)/4661.5 = 38.4 \%$
	With DG and DA	2871.3	

C) *Investigating the values of technical indices*: Technical results including operation and reliability indices are provided in Table 3 for two cases I and II. Case I refers to power flow analysis without DG and DA systems, and Case II is defined based on the proposed MILP method (19)-(26). According to Table 3, the maximum voltage deviation, daily energy loss and EENS in Case I are 0.097 p.u (allowed value is 0.1 p.u based on section 3.1), 3.141 MWh and 31.177 MWh, respectively. These values, however, are 0.018 p.u, 1.047 MWh and 5.112 MWh in Case II. This indicates that in Case II, the essential technical indices including voltage, energy loss and EENS will be improved about 81.4% $((0.097 - 0.018)/0.097)$, 66.7% and 83.6%, respectively, in comparison with Case I. Fig. 5 shows the daily apparent power curve of distribution station and voltage profile at peak load hour (20:00). Based on this figure, the daily apparent power curve is shifted downward in Case II compared to the Case I due to the injection power of capacitor banks and DGs into the distribution network. Therefore, the overloaded power during 18:00-22:00 in Case I is removed in Case II. Also, the proposed strategy considering optimal planning of DG and DA systems in Case II resulted in a flat voltage profile in comparison with Case I. In addition, Fig. 6 depicts the daily EENS, daily expected reliability cost and planning cost (summation of investment, operation and energy loss costs) curves in Case II, where the vertical axis shows the cost values and horizontal axis defines the VOLL values. It is seen in Fig. 6 (a), as the value of VOLL increases, the EENS shows a downward trend. Firstly, it stemmed at 30 MWh for VOLL=0 \$/MWh. Since then, the curve dwindled until it reaches to its lowest value for VOLL=200 \$/MWh. In contrary to EENS, in Fig. 6 (b), the planning cost has been increased gradually from VOLL=0 to 180. Then, the planning cost has experienced a period of stabilization until it reaches to almost \$2500 for VOLL=200 \$/MWh. Focusing on Fig. 6 (b), the reliability cost shows an upward/downward trend. As can be seen, the reliability cost has been started from zero and increased steadily until it has reached to its peak which is nearly \$800 for VOLL=60 \$/MWh. Then, it has followed a downward trend and reached zero expected cost for the VOLL=200 \$/MWh. It is crystal clear that such behavior is due to concurrent minimization of investment, operation, energy loss and reliability costs. Hence, the proposed DG and DA planning strategy is able to improve both reliability and operation indices.

Table 3: Technical results of DG and DA planning in the distribution networks

Variable	Case I	Case II
Maximum voltage deviation (p.u)	0.097	0.018
Daily energy loss (MWh)	3.141	1.047
Daily EENS (MWh)	31.177	5.112

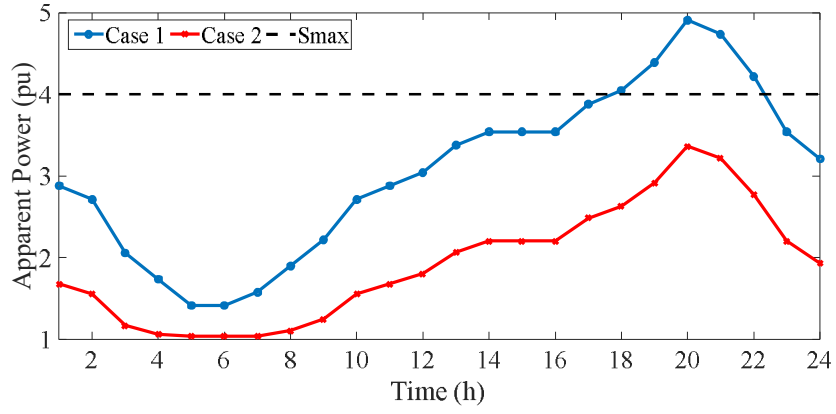

(a)

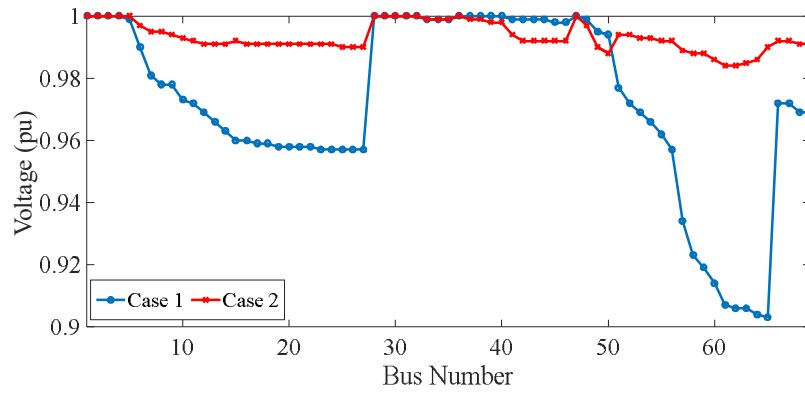

(b)

Fig. 5 a) Daily apparent power curve of distribution station, b) voltage profile at peak load hour

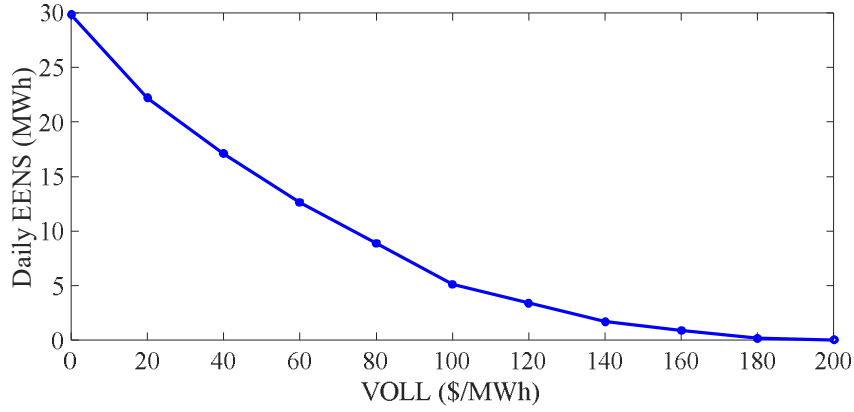

(a)

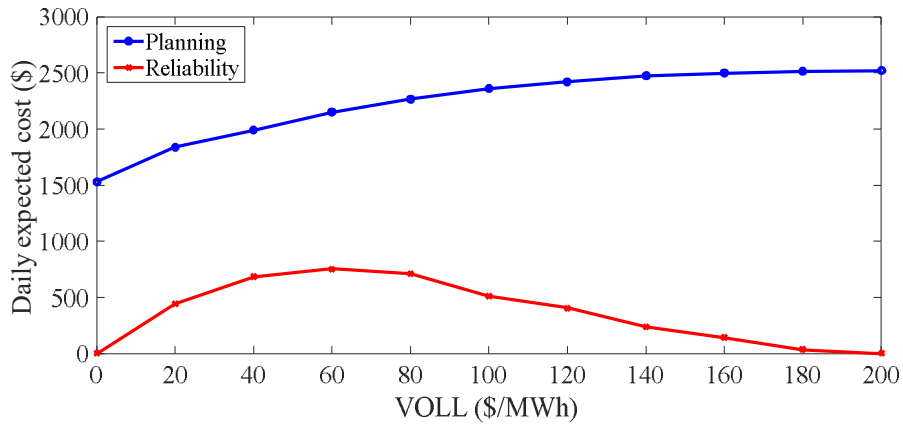

(b)

Fig. 6: a) EENS curve, b) reliability and planning cost curves versus VOLL in Case II

4. Conclusions

In this paper, the optimal planning of distributed generation and distribution automation systems in the distribution network has been presented to improve reliability and operation indices. Firstly, the studied planning model has been obtained as a mixed-integer nonlinear model. To avoid non-convex and non-linear problems, the proposed original model has been converted to a mixed-integer linear format using effective linearization techniques. Also, a stochastic programming approach has been employed to model the uncertainty associated with load, energy price, and availability of network equipment. It is found that the proposed mixed-integer linear model is able to achieve the more optimal solution in comparison with nonlinear models at low computational time and error according to the numerical results. Moreover, the proposed strategy of distributed generation and distribution automation planning in the distribution network can improve the reliability and operation indices, and reduce operation, energy loss and reliability costs, while obtaining the optimal location of

sources and distribution automation systems in the distribution network. The proposed scheme succeeded to reduce voltage deviation, energy loss, and the sum of planning and reliability cost within the range of 81.4%, 66.7%, and 38.4% compared to those of power flow studies. Additionally, with increased value of loss of load, VOLL, it can achieve high reliability in the distribution system.

In the proposed plan, the installation time of DGs and DAs could not be calculated, therefore, the proposed problem can be modelled in accordance with dynamic planning to calculate the installation of the mentioned equipment in the planning horizon in the future works following the mentioned issue. In addition, variable capacitors such as switched capacitors have desirable features such as voltage regulation with respect to the fixed capacitor used in the proposed design. However, they cost more to install than fixed capacitors. Also, the programming of variable capacitors in the proposed design to achieve its capability in the distribution network is intended as another future work. It is also generally advisable to report the investment risks to encourage investors to install DG and DA in the distribution network. Therefore, this issue will be presented in the future works in accordance with the proposed problem.

References

- [1] A. Shahbazi, J. Aghaei, S. Pirouzi, M.R. Shafie-khah, J.P.S. Catalão, “Hybrid stochastic/robust optimization model for resilient architecture of distribution networks against extreme weather conditions,” *International Journal of Electrical Power & Energy Systems*, vol. 126, pp. 106576, 2021.
- [2] A. Shahbazi, and et al., “Holistic approach to resilient electrical energy distribution network planning,” *International Journal of Electrical Power & Energy Systems*, vol. 132, pp. 107212, 2021.
- [3] S. Heidari, M. Fotuhi-Firuzabad and S. Kazemi, “Power distribution network expansion planning considering distribution automation,” *IEEE Transactions on Power Systems*, vol. 30, no. 3, pp. 1261-1269, May 2015.
- [4] A. Ghosh, and G. Ledwich, Power quality enhancement using custom power devices, *Kluwer Academic Publishers, USA*, 2002.
- [5] D. Borowski and R. Seamon, “EPRI project RP2592, large scale distribution automation and load control, enters test year,” *IEEE Trans. Power Del.*, vol. 5, no. 1, pp. 486–492, Jan. 1990.
- [6] A. M. Pasha, H. H. Zeineldin, E. F. El-Saadany and S. S. Alkaabi, “Optimal allocation of distributed generation for planning master–slave controlled microgrids,” *IET Generation, Transmission & Distribution*, vol. 13, no. 16, pp. 3704-3712, 2019.

- [7] J. Gao *et al.*, “Zonotope-based method for optimal allocation of wind capacity in microgrids considering generation uncertainty,” *IET Renewable Power Generation*, vol. 13, no. 16, pp. 2994-3001, 2019.
- [8] D. Huang, H. Li, G. Cai, N. Huang, N. Yu and Z. Huang, “An efficient probabilistic approach based on area grey incidence decision making for optimal distributed generation planning,” *IEEE Access*, vol. 7, pp. 93175-93186, 2019.
- [9] E. Hooshmand and A. Rabiee, “Robust model for optimal allocation of renewable energy sources, energy storage systems and demand response in distribution systems via information gap decision theory,” *IET Generation, Transmission & Distribution*, vol. 13, no. 4, pp. 511-520, 2019.
- [10] M. E. Hamidi and R. M. Chabanloo, “Optimal allocation of distributed generation with optimal sizing of fault current limiter to reduce the impact on distribution networks using NSGA-II,” *IEEE Systems Journal*, vol. 13, no. 2, pp. 1714-1724, 2019.
- [11] M. Pau, F. Ponci and A. Monti, “Optimal placement of sectionalizing switches for radial distribution grids,” *2019 1st International Conference on Energy Transition in the Mediterranean Area (SyNERGY MED)*, Cagliari, Italy, pp. 1-6, 2019.
- [12] S. Heidari, M. Fotuhi-Firuzabad and M. Lehtonen, “Planning to equip the power distribution networks with automation system,” *IEEE Transactions on Power Systems*, vol. 32, no. 5, pp. 3451-3460, 2017.
- [13] S. Heidari and M. Fotuhi-Firuzabad, “Integrated planning for distribution automation and network capacity expansion,” *IEEE Transactions on Smart Grid*, vol. 10, no. 4, pp. 4279-4288, 2019.
- [14] M. Lwin, J. Guo, N. Dimitrov and S. Santoso, “Protective device and switch allocation for reliability optimization with distributed generators,” *IEEE Transactions on Sustainable Energy*, vol. 10, no. 1, pp. 449-458, 2019.
- [15] V. Farahani, B. Vahidi, and H. Askarian Abyaneh, “Reconfiguration and capacitor placement simultaneously for energy loss reduction based on an improved reconfiguration method,” *IEEE Trans. Power Syst.*, vol. 27, no. 2, pp. 587–595, 2012.
- [16] S. Pirouzi, J. Aghaei, M.A. Latify, G.R. Yousefi, and G. Mokryani, “A robust optimization approach for active and reactive power management in smart distribution networks using electric vehicles,” *IEEE System Journal*, pp. 1-12, 2017.
- [17] H. Hamidpour, J. Aghaei, S. Dehghan, S. Pirouzi, T. Niknam, “Integrated resource expansion planning of wind integrated power systems considering demand response programmes,” *IET Renewable Power Generation*, vol. 13, no.4, pp. 519-529, 2018.

- [18] H. Hamidpour, J. Aghaei, S. Pirouzi, S. Dehghan, T. Niknam, "Flexible, Reliable and Renewable Power System Resource Expansion Planning considering Energy Storage Systems and Demand Response Programs," *IET Renewable Power Generation*, (accepted), 2019.
- [19] R. Homayoun, and et al. "Multi-objective operation of distributed generations and thermal blocks in microgrids based on energy management system," *IET Generation, Transmission and Distribution*, (accepted), 2021.
- [20] M.A. Norouzi, J. Aghaei, S. Pirouzi, T. Niknam, M. Lehtonen, "Flexible operation of grid-connected microgrid using ES," *IET Generation, Transmission & Distribution*, vol. 14, no. 2, pp. 254-264, 2019.
- [21] A. Dini, S. Pirouzi, M.A. Norouzi, M. Lehtonen, "Hybrid stochastic/robust scheduling of the grid-connected microgrid based on the linear coordinated power management strategy," *Sustainable Energy, Grids and Networks*, vol. 24, pp. 100400, 2020.
- [22] A. Kavousi-Fard, A. Khodaei, "Efficient integration of plug-in electric vehicles via reconfigurable microgrids," *Energy*, vol. 111, pp. 653-663, 2016.
- [23] A. Shahbazi, J. Aghaei, S. Pirouzi, T. Niknam, M.R. Shafie-khah, J.P.S Catalão, "Effects of resilience-oriented design on distribution networks operation planning," *Electric Power Systems Research*, vol. 191, pp. 106902, 2021.
- [24] H. Kiani, K. Hesami, A.R. Azarhooshang, S. Pirouzi, S. Safaee, "Adaptive robust operation of the active distribution network including renewable and flexible sources," *Sustainable Energy, Grids and Networks*, vol. 26, pp. 100476, 2021.
- [25] S. Pirouzi, J. Aghaei, T. Niknam, M. Shafie-Khah, V. Vahidinasab, J.P.S Catalão, "Two alternative robust optimization models for flexible power management of electric vehicles in distribution networks," *Energy*, vol. 141, pp. 635-651, 2017.
- [26] J. Aghaei, S.A. Bozorgavari, S. Pirouzi, H. Farahmand, M. Korpås, "Flexibility planning of distributed battery energy storage systems in smart distribution networks," *Iranian Journal of Science and Technology, Transactions of Electrical Engineering*, vol. PP, pp. 1-17, 2019.
- [27] A. Rohani, M. Abasi, A. Beigzadeh, M. Joorabian, G.B. Gharehpetian, "Bi-level power management strategy in harmonic-polluted active distribution network including virtual power plants," *IET Renewable Power Generation*, vol. 15, no. 2, pp. 462-476, 2021.

- [28] S.A. Bozorgavari, J. Aghaei, S. Pirouzi, V. Vahidinasab, H. Farahmand, M. Korpås, “Two-stage hybrid stochastic/robust optimal coordination of distributed battery storage planning and flexible energy management in smart distribution network,” *J. Energy Storage*, vol. 26, pp. 1-2, 2019.
- [29] A. Kavousi-Fard, T. Niknam, and M. Fotuhi-Firuzabad, “Stochastic reconfiguration and optimal coordination of V2G plug-in electric vehicles considering correlated wind power generation”, *IEEE Trans Sustainable Energy*, vol.6, no.3, pp.822-830, 2015.
- [30] Generalized Algebraic Modeling Systems (GAMS). [Online]. Available: <http://www.gams.com>.