



Vaasan yliopisto  
UNIVERSITY OF VAASA

**OSUVA** Open  
Science

This is a self-archived – parallel published version of this article in the publication archive of the University of Vaasa. It might differ from the original.

## Evaluating the Impact of Bilateral Contracts on the Offering Strategy of a Price Maker Wind Power Producer

**Author(s):** Rashidizadeh-Kermani, Homa; Vahedipour-Dahraie, Mostafa; Shafie-khah, Miadreza; Siano, Pierluigi

**Title:** Evaluating the Impact of Bilateral Contracts on the Offering Strategy of a Price Maker Wind Power Producer

**Year:** 2022

**Version:** Accepted version

**Copyright** ©2022 IEEE. Personal use of this material is permitted. Permission from IEEE must be obtained for all other uses, in any current or future media, including reprinting/republishing this material for advertising or promotional purposes, creating new collective works, for resale or redistribution to servers or lists, or reuse of any copyrighted component of this work in other works.

**Please cite the original version:**

Rashidizadeh-Kermani, H., Vahedipour-Dahraie, M., Shafie-khah, M. & Siano, P. (2022). Evaluating the Impact of Bilateral Contracts on the Offering Strategy of a Price Maker Wind Power Producer. *IEEE Transactions on Industrial Informatics* 18(7), 4331-4341.  
<https://doi.org/10.1109/TII.2021.3124900>

# Evaluating the Impact of Bilateral Contracts on the Offering Strategy of a Price Maker Wind Power Producer

Homa Rashidizadeh-Kermani, Mostafa Vahedipour-Dahraie, Miadreza Shafie-khah, *Senior Member, IEEE*, and <sup>1</sup>Pierluigi Siano, *Senior Member, IEEE*

**Abstract**— Due to the high penetration of wind power generation in power systems and electricity markets, Wind Power Plants (WPPs) can, <sup>1</sup>in some scenarios, influence the market prices and exercise market power in the day-ahead (DA) market. In order to evaluate the capability of WPPs to directly act as price-maker, this paper proposes the strategic offering of a WPP in the DA market by using a bi-level stochastic optimization approach. The primary objective of the proposed model is to maximize the WPP's expected profit by strategically offering in DA market while minimizing the energy deviations in the regulating market. Moreover, the WPP can also sign bilateral contracts with customers to supply their required energy. In the sub-problem, the system operator (SO) tends to minimize the sum of the total generation costs minus the sum of the total demand benefits. The effect of bilateral contracts on the strategic offering of WPP in the DA market and its impact on the transmission margin are also investigated. Results on real cases show that when the WPP enters into a bilateral contract, it should consider the effect of such contracts on the offering strategy to the DA market. The effects of bilateral contracts on the regulating market are also examined.

**Index Terms**—Bilateral contract, line congestion, strategic offering, market power, wind power plant (WPP).

## NOMENCLATURE

### Sets and indices

$(\bullet)_{t,\omega}$	At time $t$ and in scenario $\omega$ .
$k$	Line number
$n$	Bus number
$t \in T$	Set of time.
$G \in NG$	Set of generation units.
$W \in NW$	Set of wind generation unit $W$ .
$D \in ND$	Set of demand load $D$ .
$D_B$	Set of demand load $D_B$ in bilateral contract $B$ .
$\in ND_B$	
$s(k) = n$	Sending-end bus of line $k$ .
$r(k) = n$	Receiving-end bus of line $k$ .

### Parameters

$B_k$	Susceptance of line $k$ (p.u).
$\bar{P}_D$	Upper limit of demand $D$ (MW).

$\bar{P}_G$	Upper limit of generation DG unit (MW).
$\bar{P}_W$	Wind power capacity of wind power unit $W$ (MW).
$\bar{P}_{D_B}$	Upper limit of demand $D_B$ in bilateral contracts (MW).
$P_{t,\omega}^P$	Wind power generated by the wind power unit (MW)
$f_k^{\max}$	Transmission capacity of line $k$ (MW).
$k_{t,\omega}$	Wind power capacity factor (MW)
$\lambda_{D_B,t}$	Bilateral contract price (€/MWh).
$\lambda_{D,t}$	Marginal utility of demand $D$ (€/MWh).
$\lambda_{W,t}^P$	Marginal cost of the wind power unit $W$ (€/MWh).
$\lambda_{G,t}$	Marginal cost of generation DG unit (€/MWh).
<i>Variables</i>	
$\lambda_{n,t,\omega}$	LMP at bus $n$ (€/MWh).
$P_{W,t,\omega}^{cl}$	Wind power cleared in the DA market for wind power unit $W$ (MW).
$P_{t,\omega}^{of}$	Wind power offered to DA market by wind power unit (MW).
$P_{G,t,\omega}$	Power scheduled to be produced by the generation DG unit (MW).
$P_{t,\omega}^{dn/up}$	Down/up regulation power (MW).
$\alpha_{W,t}$	Offer price of wind power unit $W$ (€/MWh).
$P_{D,t,\omega}$	Scheduled power to be consumed by demand $D$ (MW).
$\delta_n$	Voltage angle at bus $n$ .
$f_k$	Power flow through line $k$ (MW).
$M_k$	Transmission margin of line $k$ (MW).
$P_{D_B,t,\omega}$	Energy supplied in bilateral contract $B$ (MW).

## I. INTRODUCTION

**D**UE to energy consumption increment and environmental conservation concerns from one side and fossil fuel resources decrement from the other side, penetration of renewable resources has substantially augmented throughout the world [1]-[2]. Among the renewable generations, wind power contributes a remarkable portion of the production status [3]. With increasing wind power capacity and entering of wind power generation companies into electricity markets, wind power plants (WPPs) may have an important contribution in the market such as in Denmark where WPPs may behave

<sup>1</sup> P. Siano is with Management and Innovation Systems Department, Salerno University, 84084 Fisciano, SA, Italy; Also, he is with the Department of Electrical and Electronic Engineering Science, University of Johannesburg, Johannesburg 2024, South Africa, (email: [psiano@unisa.it](mailto:psiano@unisa.it)).

Table I. The novel contributions in view of the existing state of the art.

Reference	Bi-level Modelling	LMP Method	Bilateral Contracts	Transmission Margin	Network Constraints	Simulation Purpose
[1]	✓	-	-	-	-	Investigating coordination of WPP and DR aggregators via stochastic model for participate in the DA market
[4]	✓	✓	-	-	✓	Offering strategy for a price maker WPP in DA market
[5]	✓	✓	-	-	✓	Investigating the offering strategy of aggregated hybrid power plant as a price maker in DA market via stochastic model
[7]	✓	✓	-	-	✓	Determining offering strategy of a price-maker WPP in both DA and balancing markets
[9]	-	✓	-	-	✓	Estimation of LMP in the distribution networks containing DGs
[10]	✓	✓	-	-	✓	DA market-clearing model for smart distribution systems
[11]	-	✓	-	-	✓	Integrating loads in a distribution market based on D-LMPs
[12]	-	✓	-	-	✓	Electricity market-clearing mechanism based on LMPs for pricing uncertain generation and load.
[13]	-	✓	-	✓	✓	line flow transmission margin value considering wind power integration and LMP
[14]	✓	✓	-	-	✓	Modelling the interaction between ISO and DR aggregators as well as the interaction between DR aggregators and customers
[16]	-	-	✓	-	-	Modelling the competition among a single renewable power producer against other generators.
[17]	-	-	✓	-	-	Developing incentive-based coordination mechanism between a WPP and a conventional energy supplier
This paper	✓ Using KKT conditions and duality theory	✓	✓	✓	✓	Investigating the effect of bilateral contract on the offering strategy of the WPP and on the local marginal prices in the distribution networks.

strategically to affect the electricity market prices based on their concerns [4]. In this regard, several approaches have been reported in the literature to simulate such strategic behavior in the electricity markets. A bi-level stochastic optimization model of offering strategy for an aggregated WPP and electric vehicle hybrid power plant as a price maker in DA market, while considering the uncertainties of the energy production and spot price in the real-time market, is provided in [5]. A dynamic model of the wholesale energy market, that takes into consideration the influence of uncertainties of renewable energy sources and real-time pricing with demand response, is provided in [6]. In that study, a structure that comprises real-time pricing as an underlying state is presented to obtain the dynamic interactions between generation, demand, locational marginal price (LMP), and congestion price near the equilibrium of the optimal dispatch. In [7], an offering strategy for a WPP that takes part in both day-ahead (DA) and balancing markets as a price-maker is proposed. In that study, a bi-level optimization framework is represented based on a multi-agent system and incomplete information game theory.

While there are privately owned distributed generation units within the network, making effective decisions by a distribution company is related to the control of that agent over these units through different methods considering financial incentives. One of the most effective methods to control such generation units is LMP method [8]. A stochastic method to forecast the LMP in distribution networks including distributed generation is proposed in [9], where LMP at each bus is obtained based on the share of the distributed generation in reducing power losses and emissions. In this regard, a DA market-clearing model for smart distribution systems is represented in [10], in which network reconfiguration and interactions with the wholesale market are considered via an optimization model through which

distribution LMPs are determined. In [11], distribution LMPs in a real-time distribution market managed by a distribution system operator (SO) is discussed in the presence of empowered residential end-users that can bid for energy by a demand aggregator while following demand response initiatives. An electricity market-clearing scheme based on LMPs for pricing uncertain generation and load is developed in [12]. The uncertainty related to LMPs is achieved from a distributional robust chance-constrained optimal power flow model in which only the first-order and second-order moments of the uncertain sources' probability distribution are applied. Line flow transmission margin value, considering wind power integration based on LMPs, is addressed in [13]. A new strategy for an ISO to trade demand response with different aggregators while considering various operational constraints is investigated in [14], while the effect of bilateral contracts is neglected. Based on the different LMPs at load nodes before and after wind power integration and on power flow tracing, the specific values of different grid-connected wind farms at each node are evaluated, namely, the energy value and the value of wind power. The load nodes that have a serious influence on wind power accommodation for each wind farm are also indicated.

Market designs authorizing prosumers to be directly engaged in bilateral energy exchanges brings benefits for prosumers [15]. A wind farm is linked with a hydro-pump power unit in [16] to sell the generation in the DA electricity market and also through a bilateral contract, where the imbalances are penalized in the balancing market. Although the problem of selling energy from a renewable unit through the bilateral contract and DA market is addressed in that study as a contribution, the problem of the strategic offering of wind unit with market power has been neglected. An incentive-based coordination mechanism between a wind energy supplier and a conventional energy supplier is investigated in [17]. In that study, to comply with DA schedules and to control the intermittency of wind energy generation, the wind supplier is

permitted to outsource a backup power capacity from the conventional supplier by entering a bilateral contract. Agent-based bilateral contracts of energy in the forward market environment are given in [19], where all generators and loads are assumed to submit their offers and bids, respectively. Since each generator/load participates to negotiate with the best offer/bid, the conflict of interest may occur that are modeled as a game with incomplete information. Table I is added to show the contributions of the recent works because of the existing state of the literature and the merit of the proposed method concerning other methods from the literature is cleared.

To the best of the authors' knowledge, the effect of bilateral contracts on transmission margin from a WPP viewpoint has not been addressed in the literature. In this paper, the problem of the strategic offering of a WPP taking part in a competitive electricity market is studied. In addition to the offering in the DA market, it is supposed that the WPP can sign bilateral contracts to sell its generation. Then, energy deviations are compensated in the regulating market. On the other hand, since transmission constraints may bring opportunities for the market players to enforce congestion to create an uncompetitive market, here, the effect of bilateral contracts on the transmission margin of lines in the strategic offering problem of a WPP is also investigated. To this end, the main novel contributions of this paper are listed below:

- Developing a bi-level stochastic problem to model the interaction between the WPP and SO considering network constraints and security,
- Investigating the effect of bilateral contracts on the strategic offering of a price maker WPP,
- Assessing the effect of the strategic offering of a WPP in the DA market and of signing a bilateral contract on transmission margin.

The overview of the problem description is provided in Section II. The formulation of the proposed strategic offering of WPPs in the DA market and its participation in bilateral contracts is presented in Section III. Section IV is designated to the numerical studies, and Section V concludes the paper.

## II. DESCRIPTION OF THE PROPOSED DECISION-MAKING MODEL

In a pool-based DA market, all participants including energy sellers, such as traditional/renewable generations, and energy buyers, such as various consumers, submit their sale or purchase offers to the market. In a fully competitive market environment, all participants can take part in price setting. However, in a real market, energy providers with large-scale capacities can even change electricity prices based on their interests, while other small-scale participants behave as price takers. In this paper, an offering strategy is proposed for a WPP with market power that can self-schedule the operation of its resources to maximize its expected profit. The WPP decides for both wind energy and the related offering price in the DA market. Unlike conventional generation units, the WPP has no control over its produced energy and it is completely uncertain. Because of this uncertainty, the scheduled energy generation of the WPP in the DA market is lower/higher than its real generation. To cover these uncertainties, the WPP enters the regulation market to compensate for its surplus/deficit production. In this step, the WPP should also consider the offering prices of other generation units and the bidding of demand providers.

Here, it is supposed that the aggregated loads can absorb their required energy from the wholesale market or even they can sign bilateral contracts. A bilateral contract is a free agreement signed outside an organized marketplace, between a producer and a consumer [19]. These contracts are negotiable agreements about the transaction of power between two agents. These contracts specify the terms and conditions of settlements independent of the SO. However, in this model, the SO would check and confirm enough transmission capacity for these transactions and guarantee transmission security. The bilateral contract model is very flexible as trading agents investigating their desirable requirements. However, its troubles are due to the high cost of negotiating and writing contracts, and the risk of the reputation of the partners. When the WPP enters a bilateral contract, it may satisfy its counterparties either by its local production or by purchases from the market. Once the bilateral quantity and price are fixed, the WPP should execute this contract.

Individual prosumers are permitted to submit their bids, including quantities and the corresponding prices to the operator to either buy or sell energy for a specific operating duration. The generators, except the strategic WPP, are considered fully competitive, and they offer their productions at their marginal costs. Then, the generators are paid according to the LMP of the bus at which they are located. Based on the solution that the SO takes, the won prices and quantities of generation units and consumers are determined. Fig. 1 illustrates the structure of the offering strategy of the WPP. In this problem, the WPP encounters different uncertainties including demand, wind power generation and regulation market prices that are considered as input. Then, the WPP tends to maximize its expected profit by considering different constraints. At this level, the WPP decides the price offering in the DA market and its energy trading in the regulation market. In the second level, the SO tries to minimize the sum of the total generation costs minus the sum of the total demand benefits subject to the constraints of the network. The two levels are combined with mathematical methods.

It is also supposed that:

- Load providers do not possess generation units and they purchase electricity to supply their loads from the wholesale market or through bilateral contracts.
- Energy arbitrage between bilateral contracts and wholesale market is prohibited, meaning that when the WPP enters a bilateral contract, it should satisfy its counterparties either by its local production or by purchases from the DA market. However, the loads cannot purchase power in bilateral contracts from WPP to sell in the DA market [17].

Due to the subsidies and developments in technologies, WPPs have grown in some area and have dominant positions in electricity market. Attaining such dominant positions, result in that some of the WPPs may offer strategically in electricity market with the aim of changing the clearing prices to its individual interests [4]. Under this context, in this paper an offering strategy is presented for a WPP with market power that participates in the DA market as a price-maker, and in the balancing market as a deviator.

## III. MATHEMATICAL MODEL OF THE PROPOSED BI-LEVEL PROBLEM

### A. Upper-level problem

The problem of the strategic offering of a WPP is formulated as below:

$$\text{Max} \sum_{\omega \in \Omega} \pi_{\omega} \sum_{t \in T} \left[ P_{W,t,\omega}^{cl} \lambda_{n,t,\omega} - P_{t,\omega}^P \lambda_{W,t,\omega}^P + P_{D_B,t,\omega} \lambda_{D_B,t,\omega} \right] \quad (1)$$

Subject to:

$$P_{t,\omega}^P - P_{D_B,t,\omega} - P_{t,\omega}^{dn} + P_{t,\omega}^{up} = P_{W,t,\omega}^{cl} \quad (2)$$

$$P_{t,\omega}^P \leq k_{t,\omega} \bar{P}_W \quad (3)$$

In the upper level, the WPP aims to maximize its expected profit as given in (1) including different terms. The first term includes the revenue obtained from selling wind energy production into the DA market considering the LMP of the bus at which the WPP is located. The next term consists of the costs of WPP to produce wind energy. The third term indicates the revenue from supplying bilateral contracts. The last term refers to the trading energy in the regulation market to compensate for the wind power uncertainties. Equation (2) ensures the power balance and (3) restricts the wind production.

### B. Lower level problem

The lower level problem from the SO's viewpoint is given below. The dual variables correspond with each constraint of the lower level problem and are given after a colon.

$$\text{Min} \sum_{\omega \in \Omega} \pi_{\omega} \sum_{t \in T} \left[ P_{G,t,\omega} \lambda_{G,t} + \alpha_{W,t} P_{W,t,\omega}^{cl} - P_{D,t,\omega} \lambda_{D,t} \right] \quad (4)$$

Subject to:

$$\sum_{G \in NG} P_{G,t,\omega} + \sum_{W \in NW} P_{W,t,\omega}^{cl} - \sum_{D \in ND} P_{D,t,\omega} - \sum_{D_B \in ND_B} P_{D_B,t,\omega} \quad (5)$$

$$- \sum_{k|s(k)=n} f_k + \sum_{k|r(k)=n} f_k = 0 : \lambda_{n,t,\omega}$$

$$f_k = B_k (\delta_{s(k)} - \delta_{r(k)}) : \phi_k \quad (6)$$

$$-f_k^{\max} \leq f_k \leq f_k^{\max} : \phi_k^{\min}, \phi_k^{\max} \quad (7)$$

$$0 \leq P_{D,t,\omega} \leq \bar{P}_D : \eta_D^{\min}, \eta_D^{\max} \quad (8)$$

$$0 \leq P_{D_B,t,\omega} \leq \bar{P}_{D_B} : \eta_{D_B}^{\min}, \eta_{D_B}^{\max} \quad (9)$$

$$0 \leq P_{G,t,\omega} \leq \bar{P}_G : \eta_G^{\min}, \eta_G^{\max} \quad (10)$$

$$0 \leq P_{W,t,\omega}^{cl} \leq E_{t,\omega}^{of} : \eta_W^{\min}, \eta_W^{\max} \quad (11)$$

$$-\pi \leq \delta_n \leq \pi : \xi_n^{\min}, \xi_n^{\max}, \quad \forall n \setminus n : ref \quad (12)$$

$$\delta_n = 0 : \gamma_n \quad n : ref \quad (13)$$

In the above constraints,  $\lambda_{n,t,\omega}$ ,  $\phi_k$ ,  $\phi_k^{\min}, \phi_k^{\max}$ ,  $\eta_{D_B}^{\min}, \eta_{D_B}^{\max}$ ,  $\eta_G^{\min}, \eta_G^{\max}$ ,  $\eta_W^{\min}, \eta_W^{\max}$ ,  $\xi_n^{\min}, \xi_n^{\max}$  and  $\gamma_n$  denote the dual variables. The objective function of the SO in the lower level problem is given in (4) which represents the minimization of the difference between the total generation costs and the sum of the total demand benefits. Constraint (5) indicates the power balance at each bus of the system. Constraints (6) and (7) define that the power flow through the lines is restricted by the transmission capacity limitations. Constraints (8)–(11) refer to the limits on consumed or generated power by consumers, generation units, and WPP, respectively. Equation (12) bounds the voltage angles. At last, based on the constraint (13) the voltage angle of the reference node is fixed to zero. Here, DC

model without considering losses is used for power flow. Be noted that this assumption is usually made in the technical literature and considers that voltage magnitudes are approximately constant in the system and that voltage angle differences are small enough between two connected nodes [18]. This allows us to formulate the power-flow equations using linear expressions. Also, DC power flow is widely used for diverse reasons such as the computation time and for modelling the operation problem that is a sub-problem of a long-term or a planning problem. In fact, the lower level of the bi-level model (from SO's viewpoint) is not the main focus of this paper. So, due to the mentioned complexity, in a large number of operation models in the literature, the network constraints have not been even addressed such as [20].

### C. Combining Lower level and Upper level of the problem

The lower level problem given in (4)–(13) is linear and can be replaced by its equal problem using Karush-Kuhn-Tucker optimality constraints [21].

$$\lambda_{G,t} - \lambda_{n,t,\omega} - \eta_G^{\min} + \eta_G^{\max} = 0 \quad (14)$$

$$\alpha_{W,t} - \lambda_{n,t,\omega} - \eta_W^{\min} + \eta_W^{\max} = 0 \quad (15)$$

$$\lambda_{D,t} - \lambda_{n,t,\omega} - \eta_D^{\min} + \eta_D^{\max} = 0 \quad (16.a)$$

$$\lambda_{D_B,t} - \lambda_{n,t,\omega} - \eta_{D_B}^{\min} + \eta_{D_B}^{\max} = 0 \quad (17.b)$$

$$\lambda_{n(s),t,\omega} - \lambda_{n(r),t,\omega} - \phi_k - \phi_k^{\min} + \phi_k^{\max} = 0 \quad (17)$$

$$\sum_{k|s(k)=n} B_k \phi_k - \sum_{k|r(k)=n} B_k \phi_k - \xi_n^{\min} + \xi_n^{\max} = 0, \quad \forall n \setminus n : ref \quad (18)$$

$$\sum_{k|s(k)=n} B_k \phi_k - \sum_{k|r(k)=n} B_k \phi_k - \gamma_n = 0, \quad n : ref \quad (19)$$

$$0 \leq \phi_k^{\max} \perp f_k^{\max} - f_k \geq 0 \quad (20)$$

$$0 \leq \phi_k^{\min} \perp f_k + f_k^{\max} \geq 0 \quad (21)$$

$$0 \leq \eta_D^{\max} \perp \bar{P}_D - P_{D,t,\omega} \geq 0 \quad (22)$$

$$0 \leq \eta_D^{\min} \perp P_{D,t,\omega} \geq 0 \quad (23)$$

$$0 \leq \eta_{D_B}^{\max} \perp \bar{P}_{D_B} - P_{D_B,t,\omega} \geq 0 \quad (24)$$

$$0 \leq \eta_{D_B}^{\min} \perp P_{D_B,t,\omega} \geq 0 \quad (25)$$

$$0 \leq \eta_G^{\min} \perp P_{G,t,\omega} \geq 0 \quad (26)$$

$$0 \leq \eta_G^{\max} \perp \bar{P}_G - P_{G,t,\omega} \geq 0 \quad (27)$$

$$0 \leq \eta_W^{\max} \perp P_{t,\omega}^{of} - P_{W,t,\omega}^{cl} \geq 0 \quad (28)$$

$$0 \leq \eta_W^{\min} \perp P_{W,t,\omega}^{cl} \geq 0 \quad (29)$$

$$0 \leq \xi_n^{\max} \perp (\pi - \delta_n) \geq 0, \quad \forall n \setminus n : ref \quad (30)$$

$$0 \leq \xi_n^{\min} \perp (\pi + \delta_n) \geq 0, \quad \forall n \setminus n : ref \quad (31)$$

In the above constraints,  $P_{W,t,\omega}^{cl}$  and  $\lambda_{n,t,\omega}$  denote the control variable. The problem given above is nonlinear because of the term  $P_{W,t,\omega}^{cl} \lambda_{n,t,\omega}$  in the objective function in (1) as well as the complementarity constraints in (20)–(31). Using the strong duality theorem [22] and some mathematical relaxation, the term  $P_{W,t,\omega}^{cl} \lambda_{n,t,\omega}$  can be transformed into a linear form.

Moreover, using the Fortuny-Amat transformation as used in [23], the nonlinear constraints in complementarity conditions can be transformed into their equivalent linear constraints. Finally, by using the mentioned linearization expressions, the

problem of the strategic offering of a WPP is formulated as below:

$$\text{Max} \sum_{\omega \in \Omega} \pi_{\omega} \sum_{t \in T} \left[ \begin{array}{l} \sum_{D \in ND} P_{D,t,\omega} \lambda_{D,t} + P_{D_B,t,\omega} - \sum_{G \in NG} P_{G,t,\omega} \lambda_{G,t} \\ - \sum_k f_k^{\max} (\phi_k^{\min} + \phi_k^{\max}) \\ \sum_{G \in NG} (-\eta_G^{\max} \bar{P}_G - \eta_D^{\max} \bar{P}_D) - \sum_n \pi (\xi_n^{\min} + \xi_n^{\max}) \\ - \sum_{W \in NW} P_{t,\omega}^P \lambda_{W,t}^P + P_{t,\omega}^{dn} \lambda_{t,\omega}^{dn} - P_{t,\omega}^{up} \lambda_{t,\omega}^{up} \end{array} \right] \quad (32)$$

Subject to the constraints in (2), (3), (5)-(13), (14)-(19) and the constraints based on Fortuny-Amat McCarl linearization, the complementarity constraints in (20)-(31) are provided as explained in [24].

The algorithm for solving the bi-level, two-stage optimization problem to solve the strategic offering of the WPP is shown in Fig. 2. It is seen that firstly, the scenarios are generated and reduced to a limited set and then, using KKT optimality constraints and other mathematical solutions, the outputs are obtained.

#### D. Bilateral contract modeling

Most companies commonly engage in bilateral contracts, called power purchase agreements (PPA), with renewable energy producers to buy their energy production. PPAs are used for various types of bilateral energy trading, depending on the types of sellers and buyers [25]. In particular, a *renewable-based corporate PPA* is a bilateral contract between an energy-consuming company, which commits to buying future energy generation of a renewable resource for predetermined agreed-upon prices. In this regard, in this work, based on bilateral contract-based peer to peer energy trading mechanism, the system operator (SO) operates as an agent where the trading offers are posted and handshakes are made. Then, the buyers such as aggregated bilateral load and sellers such as WPP register for a certain period. Then, the buyers and sellers give their prices and quantities.

After that, purchasing offers are sent to the sellers and selling offers are broadcasted to the buyers. By the way, all offers are displayed on a platform where all buyers and sellers can look for accessible offers. When a buyer has the willingness to make a deal with a seller, it sends a contract to the seller and request confirmation. The same as that, the sellers can seek purchasing offers and ask for approval to deal with. When a contract is confirmed, it will be sent to the SO for final confirmation from the viewpoint of security. To prevent multiple buying, the corresponding offers of the contracts will be removed from the platform.

In this context, in the bilateral contract, the WPP can supply the loads based on predetermined and fixed bilateral price  $\lambda_{D_B,t}$ . However, the total demand supplied through bilateral contracts  $P_{D_B,t,\omega}$  cannot exceed the maximum capacity that is contracted  $\bar{P}_{D_B}$ . The following constraints give the modeling of this bilateral contract:

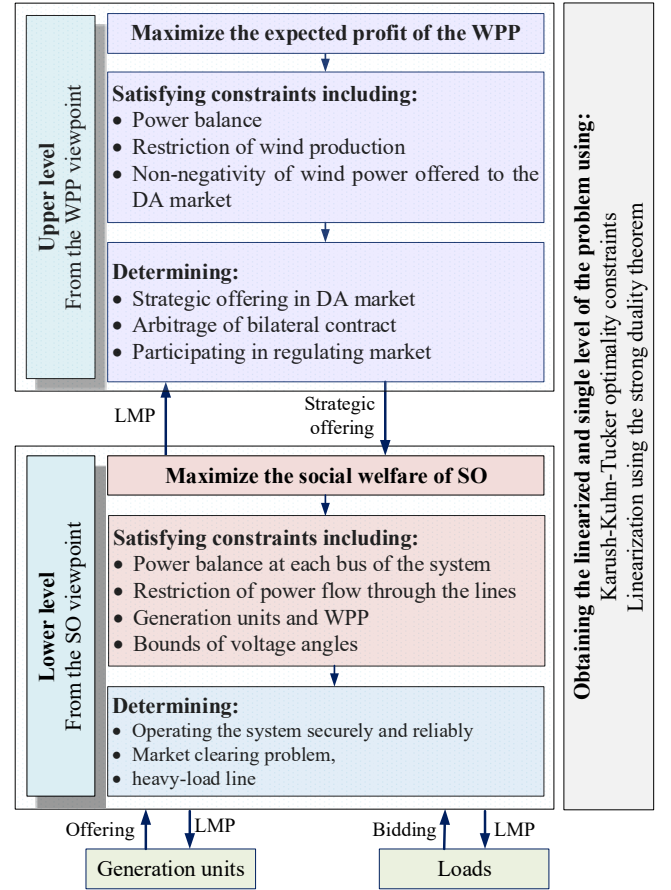

Fig. 1. The structure of offering strategy of the WPP in DA market.

$$B_{D_B,t,\omega} = \sum_{D_B \in ND_B} P_{D_B,t,\omega} \lambda_{D_B,t} \quad (33)$$

$$0 \leq P_{D_B,t,\omega} \leq \bar{P}_{D_B} \quad (34)$$

#### A. Modelling Transmission Margin of Lines

The transmission margin of each line is obtained with the following expression:

$$M_k = 1 - \frac{|f|}{f_k^{\max}} \quad (35)$$

where,  $M_k$  stands for the transmission margin of line  $k$ ,  $f$  and  $f_k^{\max}$  is the power flow and the maximum transmission capacity of line  $K$ . According to the actual operation of a power grid, if  $M_k$  reaches to 80% of its transmission capacity, then it is considered as a heavy-load line.

## IV. CASE STUDY AND NUMERICAL RESULTS

### A. Case Study and Input Data

In this section, the proposed strategic scheduling model is implemented to a three-bus system that is selected for its ability to show the conception, also the IEEE 24-bus RTS to illustrate the framework in a larger system [26]. For the sake of simplicity, a three-node network including a WPP at bus 1 with the capacity of 25MW that the related scenarios are extracted from [27]. Two-generation units are located at the other two buses with the capacity of 10 and 20MW. Also, a load is located at each bus as shown in Fig. 3. The regulation prices are extracted from Nordpool market [28] as illustrated in Fig. 4.

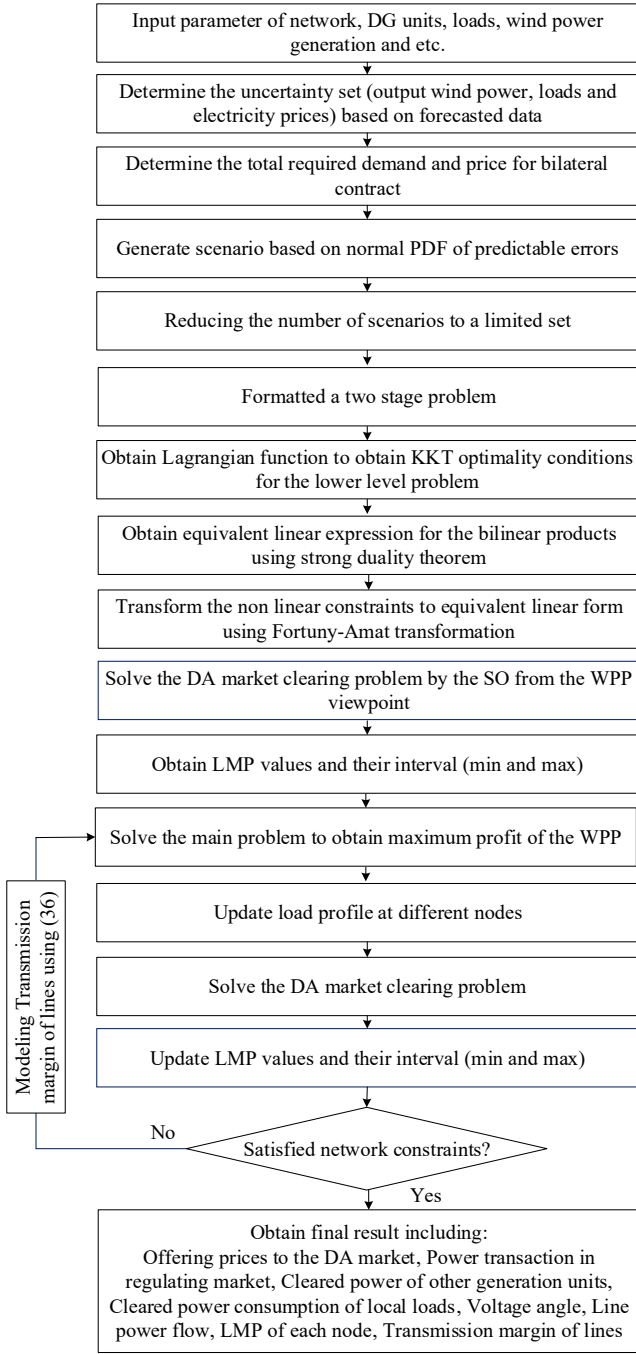

Fig. 2. Flow chart of solution methodology.

The bidding price of loads is shown in Fig. 5 and the demand of each bus as well as the bilateral demand are illustrated in

Fig. 6. The subscript 1, 2 and 3 refer to the loads located at buses 1, 2 and 3. Also, subscript 4 shows the bilateral contract.

Here, the WPP as a decision maker should decide optimal decisions to avoid implementing strategies that may entail the possibility of high costs or low profits. Therefore, before offering to DA market, the WPP should evaluate the portfolio of results in advance to make a better decision. In this context, the condition without investigating bilateral contract corresponds to the *base case* and other conditions with considering bilateral contract are compared with the base case to provide a profile for decision maker. In this regard, two different cases are taken into consideration defined as bellow:

- Case 1: The demand at bus 1 is supplied through the wholesale market, completely.
- Case 2: Only 60% of the total load of bus 1 is supplied from participation in the wholesale market and 40% of that load is supplied through a bilateral contract.

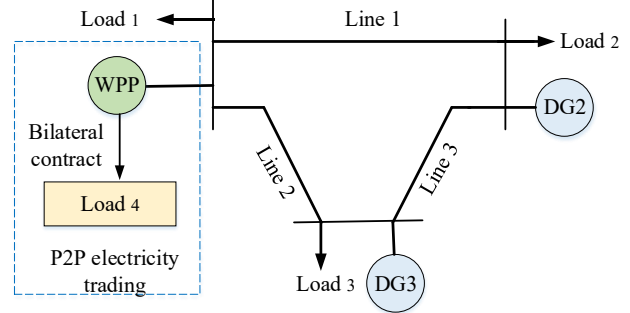

Fig. 3. Three bus network system

Data of generation units and demands as well as the susceptance of all lines are extracted from [18] and the maximum capacity of all lines is 5MW. The scheduling horizon is assumed one day with 24 equal time slots. Simulations were run using CPLEX 12.6.0.0 under GAMS 24.2.2 [29] on a Dell Precision laptop with an Intel Core™ i7@2.6GHz processor and 16 GB of RAM. It should be noted that considering a *mip gap* of 0%, the computation time for the studied cases was between 3 and 6 minutes, with an average of 4 min and 42 seconds.

#### A. Numerical Results for Three-Bus System

Fig. 7 shows the forecasted wind power generation of the WPP and its offering power to the DA market and the cleared power by the SO in both cases without and with bilateral contracts. The generated wind power is forecasted with three scenarios that its expected value is shown with bars that is the same in both cases. The WPP submits its production offers including the quantities and prices (only quantities are shown in this figure) to the DA market. Then, the SO clears the DA market. When the WPP does not enter a bilateral contract, it offers the expected value of wind generation to the DA market. But, when the WPP enters a bilateral contract, first, it tends to supply the predetermined aggregated bilateral load with its local generation and the additional forecasted wind generation is offered to the SO.

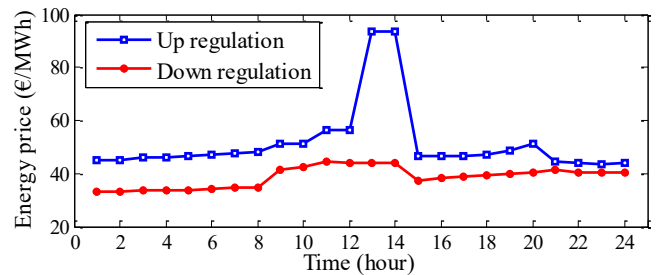

Fig. 4. Up and down regulation prices

In both cases, the wind power cleared in the DA market is equal to the wind power production plus the power that should be sold/bought in the regulating market.

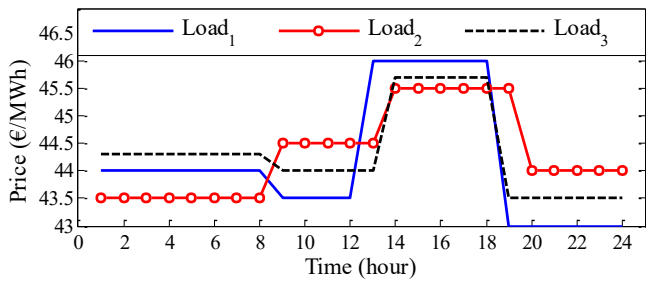
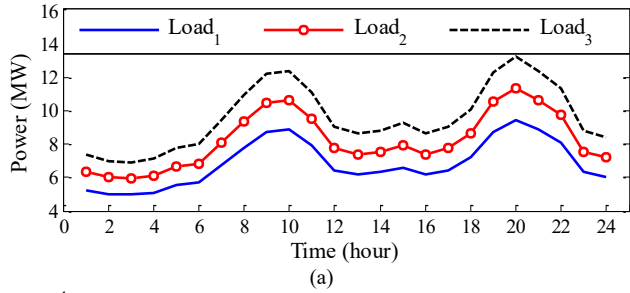
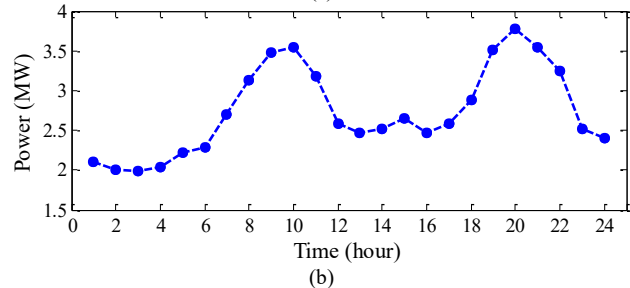

Fig. 5. Bidding price of loads



(a)



(b)

Fig. 6. The demand of loads (a) located at all buses (b) aggregated bilateral load.

It is seen that in the same forecasted produced wind power in both cases when there is no bilateral contract, the WPP usually offers much more power to the DA market, while it offers lower amounts of power when there exists a bilateral contract outside the marketplace. Moreover, the WPP offers lower wind power production into the DA electricity market through a bilateral contract, because it might face a high risk of a low generation that should be bought in the costly regulation market. The gap between the red line (offered power) and the blue line (cleared power) indicates that the WPP sells/purchases the surplus/deficit production in the balancing market. Here, to better show the details, Fig. 8 gives the offered wind power to the SO in both cases with and without bilateral contract. As it can be seen, the difference between the offered power in the two cases is not the same.

To better shown, the offered power at 4:00, 10:00 and 20:00 in both cases are also given in the boxes. As it can be seen from Fig. 7, the shape of the offered/cleared power of the WPP in case of with and without a bilateral contract is approximately the same. The gap between the offered power in the two cases is because of the required demand in a bilateral contract. In fact, when the WPP enters a bilateral contract, first, it tends to supply the predetermined aggregated bilateral load shown in Fig. 6 (b) with its local generation and the additional forecasted wind generation is offered to the SO. The cleared power by the SO at each hour follows the offering trend and is surely lower than the offered power. However, the value of cleared power differs in both cases.

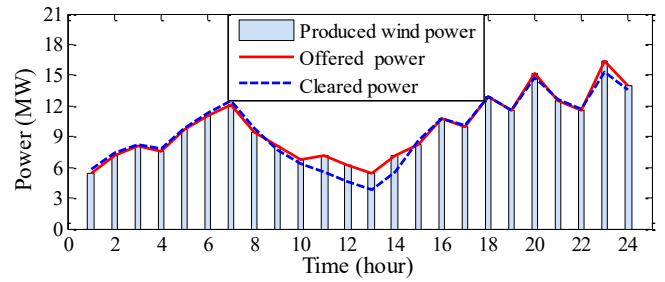

(a)

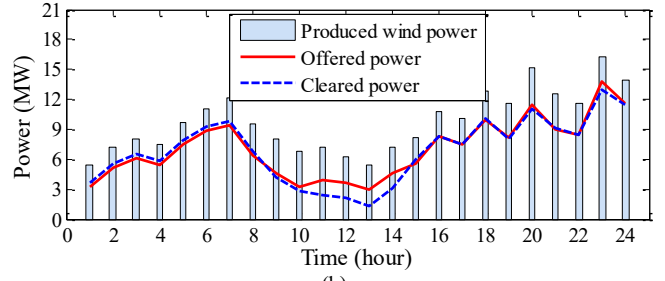

(b)

Fig. 7. The wind power generated and offered in the cases of (a) without and (b) with bilateral contracts.

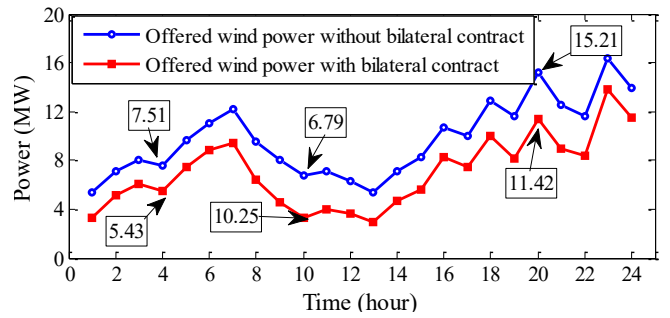

Fig. 8. Offered wind power in cases of with and without bilateral contracts.

Fig. 9 illustrates both wind generation and bilateral load in (a) and the compensation of energy imbalances in the regulating market in (b). It is seen that bilateral contract turns out aggressive changes in energy arbitrating in the regulating market. To better show the changes, energy deficit and energy surplus in (b) are drawn. Be noted that the scales are in MW that a small change in the trend of the figure makes MW amounts. The WPP sells the surplus energy in the down-regulation market with lower prices and purchases the energy deficit with higher prices as shown in Fig. 4. When a bilateral contract exists, the excess of energy that should be sold in the down-regulation market decreases as in Fig. 9-(b). In this case, the WPP might purchase the energy deficit from the up-regulation market with higher prices. Meaning that when there exists a bilateral contract, the WPP may encounter lower energy that should be supplied in the up-regulation. It is surely because of the responsibility of the WPP to supply the aggregated bilateral load. It should be mentioned that from 10:00 to 14:00, there is low wind generation (please see the energy forecasted in Fig. 9 (a)). So, the energy deficit in both cases is very high that should be purchased from the balancing market. As expected, during this duration, the energy surplus is zero. It can be therefore deduced that by exchanging energy in a bilateral contract, trading excess of energy in the down-regulation market decreases.



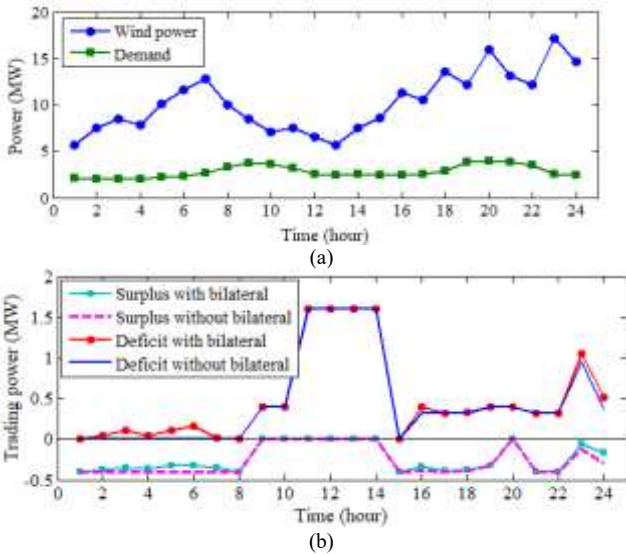

Fig. 9. (a) Wind generation and bilateral load, (b) Trading power in regulating market with and without bilateral contract.

Although, the energy deficit to supply the contracted load augments in some hours that should be compensated in the up-regulation market. In fact, a bilateral contract causes to offset a part of the surplus energy rather than being fully penalized in the down-regulation market. In other words, a bilateral contract allows the WPP to offer appropriately such that the surplus energy that must be curtailed or sold with a lower price in the down-regulation market be mitigated. Nevertheless, it might require purchasing the energy deficit from the up-regulation market when executing bilateral contracts. Moreover, in this figure, in the period 1:00-8:00, when the WPP signs a bilateral contract, it may face some deficit power. In fact, the WPP might encounter a higher lack of generation when it signs bilateral contracts. So, its participation in the up-regulation market to purchase the energy deficit augments to supply the contracted load specifically during 1:00 to 8:00 as in Fig. 9, (b).

The cleared power of WPP and other generation units in the DA market in both cases without and with bilateral contracts are depicted in Fig. 10. Accordingly,  $DG_2$  as a cheap unit commits during the whole day to cause a drop in total operating costs in both cases. Based on the proposed bi-level problem, there is required to commit the expensive unit  $DG_3$  sometimes specifically during the night, midnight and early in the morning that the wind generation is low. However, from 8:00 to 13:00 that the wind power generation is low, the regular load should be supplied from the other generation units such as  $DG_3$ . However, when the WPP enters a bilateral contract, there is an obligation to execute the contract and supply the required demand even through the local generation. In such conditions, there is less wind generation to be sold in the DA market. So, the required demand for regular loads should be supplied through the other generation units. Since  $DG_2$  has been committed completely,  $DG_3$  should commit to supply the loads requirements.

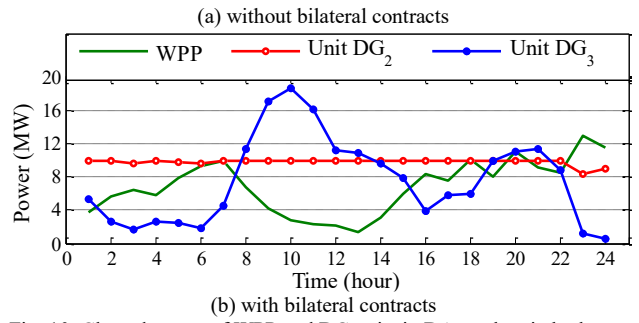
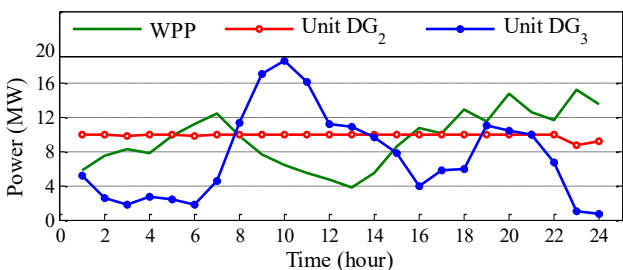

Fig. 10. Cleared power of WPP and DG units in DA market, in both cases.

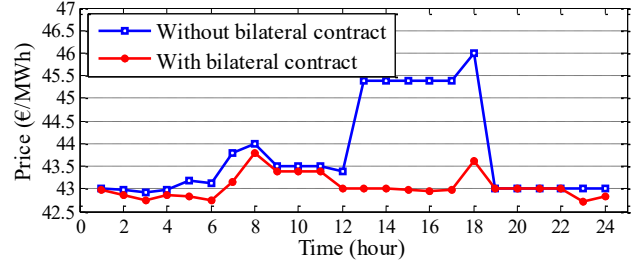

Fig. 11. Offering price in the cases of without and with bilateral contracts.

The offering price of WPP into the DA market in both cases with and without bilateral contracts are depicted in Fig. 11. It is seen that when the WPP participates in bilateral contracts, it offers at lower prices into the DA market compared with the case without it. In the cases without a bilateral contract, the strategic WPP with market power offers high prices to augment its profit. In contrast, when the WPP enters into a contract, it might be willing to offer lower prices in the hope of obtaining higher profit from trading energy directly.

The congestion probability of all three lines in two cases without and with bilateral contracts is given in Table II. It is seen that in the case without a bilateral contract, line  $L_2$  is more probable (about 22.5%) to be congested heavily with the load rate more than 80% than the other two lines. In this case, line1 and Line3 are never congested heavily. But, through bilateral contracts, the load rate of Line2 decreases about 4.6% (from 22.5% to 21.5%). But, when the WPP signs a bilateral contract, since a part of the load is supplied locally, the congestion of lines decreases.

Fig. 12 depicts the LMP at each node of the system through the whole day in both cases without and with a bilateral contract. As seen, the system LMP differs in both cases. Lower system LMPs occur when the WPP enters bilateral contracts. That is because when the bilateral contract is fulfilled by local wind generation, the strategic WPP offers lower prices to the DA market in the hope of obtaining higher profit from the energy arbitrage in a bilateral contract. Also, out of the marketplace, the WPP can benefit from bilateral contracts as long term agreements and sell its wind generation through such contracts instead of in the wholesale market. This prevents the WPP from confronting the upstream volatility and even, it can sell its generation to the network, when the required demand in a bilateral contract is low.

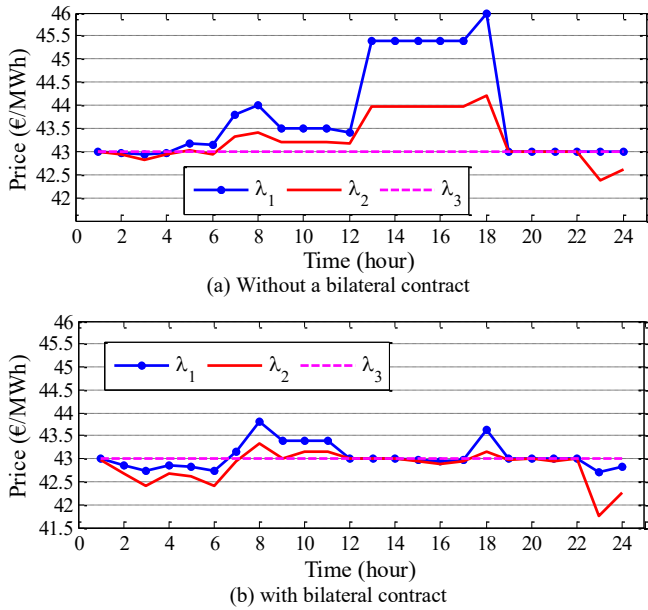

Fig. 12. Locational marginal pricing at each node

TABLE II. THE PROBABILITY OF LINE CONGESTIONS IN CASES WITH AND WITHOUT BILATERAL CONTRACTS

Line #	Line1		Line2		Line 3	
	without	with	without	with	without	with
Load rate	<b>Less than 80%</b>					
Probability	99.5%	99.43%	77.5%	78.5%	100%	100%
Load rate	<b>More than 80%</b>					
Probability	0.5%	0.57%	22.5%	21.5%	0%	0%

### B. Numerical Results for IEEE 24-Bus RTS

Additional results from a case study based on the IEEE 24-bus RTS are provided in this subsection. Data for this system is extracted from [26]. It is considered that the strategic WPP has a wind power farm that is installed at bus 7 with a capacity of 800 MW. Results of solving the problem for the offering of a strategic WPP for this case study are provided in Fig. 13 and Fig. 14. Fig. 13 illustrates the wind power offered to the DA market in both cases without and with a bilateral contract. As seen, when the WPP enters a bilateral contract, it offers a lower amount of power to the DA market. The reason is that the WPP might have a concern about supplying the loads when signing a bilateral contract. Else, the WPP may confront with being fully penalized in the regulating market to confront contracted loads. The wind power offered to the DA market varies during the day. During the early hours of the day, the WPP offers a high level of wind power to the DA market. Usually, in some of the scenarios, the offering of wind power is higher than the produced generation. However, regulating market prices in these hours are relatively low. Therefore, the WPP favor offering a high level of production to the DA market and compensate for the deviations in the regulating market in case of deficit or surplus generation. On the other hand, the wind power offered to the DA market in some of the middle hours of the day is substantially low. That is because the regulating market prices are substantially high during these hours while the wind power generation may be too low. Therefore, offering high values of wind power generation to the DA market in these hours would yield to purchasing the deficit of production occurring in some of the scenarios from a costly trading floor and paying at high regulating market prices. Thus, the WPP decides to offer low values of generation to the DA market.

Fig. 14 depicts the offering price by the WPP. The offering prices also change throughout the day. When no transmission

congestion happens, the offering prices are the same as the LMPs throughout the system. However, when the congestion occurs, the LMPs differ from the offering prices.

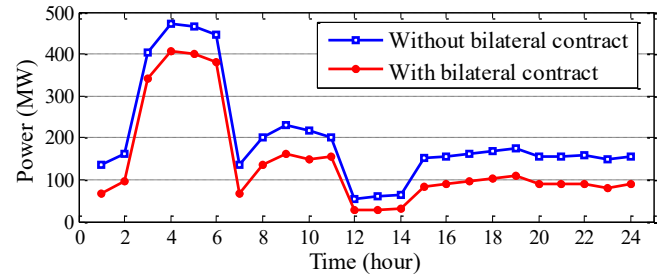

Fig. 13. Wind power offered to DA market in the cases of without and with bilateral contracts

The results show that the probability of occurring heavy load congestion (more than 80% load ability) in all lines of the system in two cases with and without bilateral contracts are about 5.4% and 5.7%, respectively. Although by signing a bilateral contract, generally the average congestion of lines decreases slightly, it is also probable that some lines become heavily congested. In other words, in general, a bilateral contract can have both a negative or a positive effect on the line congestion.

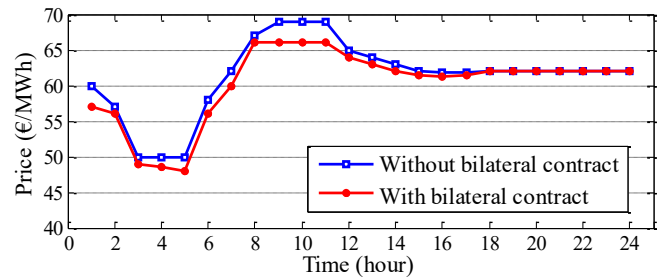

Fig. 14. Offering price in both cases of (a) without a bilateral contract and (b) with a bilateral contract

## V. CONCLUSIONS

A bi-level stochastic model for the strategic offering of a WPP in the DA market was investigated in this paper, in which at the upper level, the WPP tends to maximize its expected profit while in the lower level, the SO tried to minimize the sum of the total generation costs minus the sum of the total demand benefits. Also, the WPP signed bilateral contracts with the customers to supply their loads, directly. In this regard, here, the effect of such contracts on the strategic offering of the WPP in the DA market and also on the transmission congestion was investigated. By applying different cases, it was shown that bilateral contracts can have both a negative or a positive effect on the congestion and the results are case-sensitive. Moreover, the bilateral contract caused to offset a part of the surplus energy rather than being fully penalized in the regulation market.

Future work may include offering strategy from the viewpoint of an aggregated WPP and electric vehicle aggregator as a hybrid power plant that behaves as a price maker in the DA pool-based market. In addition, modeling both DA and regulating market-clearing price dynamics is necessary because it will impress the decision making of the hybrid power plant.

## REFERENCES

- [1] M. Asensio and J. Contreras, "Risk-Constrained Optimal Bidding Strategy for Pairing of Wind and Demand Response Resources," *IEEE Trans. Smart Grid*, vol. 8, no. 1, pp. 200-

- 208, 2017.
- [2] J. Zhao, F. Wen, Z. Y. Dong, Y. Xue, and K.-P. Wong, "Optimal dispatch of electric vehicles and wind power using enhanced particle swarm optimization," *IEEE Trans. Industrial Informatics*, vol. 8, no. 4, pp. 889-899, 2012.
  - [3] C.S. Ioakimidis, L.J. Oliveira, and K.N. Genikomsakis, "Wind power forecasting in a residential location as part of the energy box management decision tool," *IEEE Trans. Industrial Informatics*, vol. 10, no. 4, 2014, pp. 2103 – 2111.
  - [4] L. Baringo, and A. J. Conejo, "Strategic Offering for a Wind Power Producer," *IEEE Trans. Power Syst.*, vol. 28, no. 4, pp. 4645-4654, 2013.
  - [5] X. Gao, K. W. Chan, S. Xia, B. Zhou, X. Lu, D. Xu, "Risk-constrained offering strategy for a hybrid power plant consisting of wind power producer and electric vehicle aggregator," *Energy*, vol. 177, pp.183-191, 2019.
  - [6] A. Kiani Bejestani and A. Annaswamy, "A Dynamic Mechanism for Wholesale Energy Market: Stability and Robustness," *IEEE Trans. Smart Grid*, vol. 5, no. 6, pp. 2877 – 2888, 2014.
  - [7] M. Shafie-khah, E. Heydarian-Forushani, M. E. H. Golshan, M. P. Moghaddam, M. K. Sheikh-El-Eslami, and J. P. S. Catalão, "Strategic Offering for a Price-Maker Wind Power Producer in Oligopoly Markets considering Demand Response Exchange," *IEEE Trans. Industrial Informatics*, vol. 11 , no. 6, pp. 1542 – 1553, 2015.
  - [8] P. Lamaina, D. Sarno, P. Siano, A. Zakariazadeh, R. Romano, "A Model for Wind Turbines Placement Within a Distribution Network Acquisition Market," *IEEE Trans. Industrial Informatics*, vol. 11, no. 1, p p. 210-219.
  - [9] E. Azad-Farsani, H. Askarian-Abyaneh, M. Abedi, S. H. Hosseini, "Stochastic locational marginal price calculation in distribution systems using game theory and point estimate method," *IET Gen., Trans. & Dist.*, vol. 9, no. 14, pp. 1811–1818, 2015.
  - [10] L. Bai, J. Wang, C. Wang, C. Chen, F. Li, "Distribution Locational Marginal Pricing (DLMP) for Congestion Management and Voltage Support," *IEEE Trans. Power Syst.*, vol. 33, no. 4, pp. 4061 – 4073, 2018.
  - [11] P. Siano, D. Sarno, "Assessing the benefits of residential demand response in a real time distribution energy market," *Applied Energy*, vol. 161, pp. 533–551, 2016.
  - [12] X. Fang, B.-M. Hodge, E. Du, C. Kang, F. Li, "Introducing Uncertainty Components in Locational Marginal Prices for Pricing Wind Power and Load Uncertainties," *IEEE Trans. Power Syst.*, vol. 34 , no. 3, pp. 2013 – 2024, 2019.
  - [13] Y. Jiang., L. Guo, S. You, "Research on nodal wind power values and optimal accommodation based on locational marginal price," *Electrical Power and Energy Systems*, vol. 109, pp. 343–350, 2019.
  - [14] Saber Talari, Miadreza Shafie-khah, Fei Wang, Jamshid Aghaei, and João P. S. Catalão, "Optimal Scheduling of Demand Response in Pre-emptive Markets based on Stochastic Bilevel Programming Method," *IEEE Trans. Industrial Electronics*, vol. 66, no. 2, pp. 1453-1464, 2019.
  - [15] H. Kebriaei, A. Rahimi-Kian, V. Johari Majd, "An agent-based system for bilateral contracts of energy," *Expert Systems with Applications*, vol.38, pp. 11369–11376, 2011.
  - [16] A. S. Nieta, J. Contreras, and J. P. S. Catalão, "Optimal Single Wind Hydro-Pump Storage Bidding in Day-Ahead Markets Including Bilateral Contracts," *IEEE Trans. Sustain. Energy*, vol. 7, no. 3, pp. 1284- 1294, 2016.
  - [17] S. Babaei, C. Zhao, L. Fan, T. Liu, "Incentive-Based Coordination Mechanism for Renewable and Conventional Energy Suppliers," *IEEE Trans. Power Syst.*, vol.34, no. 3, pp. 1761 – 1770, 2019.
  - [18] Conejo, A.J., Castillo, E., Minguéz, R., Garcia-Bertrand, R.: *Decomposition Techniques in Mathematical Programming. Engineering and Science Applications*. Springer, Heidelberg, 2006.
  - [19] M. H. Hajimiri, M. N. Ahmadabadi, A. Rahimi-Kian, "An intelligent negotiator agent design for bilateral contracts of electrical Energy," *Expert Systems with Applications*, vol. 41, pp. 4073–4082, 2014.
  - [20] C. Zhao, J. Wang, J. Watson, "Multi-stage robust unit commitment considering wind and demand response uncertainties", *IEEE Trans. Power Syst.*, vol. 28, no. 3, pp. 2708-2717, Aug. 2013.
  - [21] H. Rashidzadeh-Kermani, M. Vahedipour-Dahraie, M. Shafie-khah, J. P.S. Catalao, "Stochastic programming model for scheduling demand response aggregators considering uncertain market prices and demands," *Int. J. of Electrical Power and Energy Systems*, vol. 113, pp. 528–538, 2019.
  - [22] H. Rashidzadeh-Kermani, M. Vahedipour-Dahraie, H.R. Najafi, Amjad Anvari-Moghaddam, Josep M. Guerrero, "A Stochastic Bi-Level Scheduling Approach for the Participation of EV Aggregators in Competitive Electricity Markets," *Appl. Sci.* vol. 7, no. 1100, pp. 1-16, 2017.
  - [23] H. Rashidzadeh-Kermani, M. Vahedipour-Dahraie, M. Shafiekhah, P. Siano, "A Regret-based Stochastic Bi-level Framework for Scheduling of DR Aggregator under Uncertainties," *IEEE Trans. Smart Grid*, vol. 11, no. 4, pp. 3171 – 3184, 2020.
  - [24] H. Rashidzadeh-Kermani, M. Vahedipour-Dahraie, M. Shafie-khah, J. P.S. Catalão, "A bi-level risk-constrained offering strategy of a wind power producer considering demand side resources," *Int. J. of Electrical Power & Energy Systems*, vol. 104, pp. 562-574, 2019.
  - [25] Y. Ghiassi-Farrokhfal, W. Ketter, J. Collins, "Making green power purchase agreements more predictable and reliable for companies," *Decision Support Systems*, vol. 144, May 2021, 113514.
  - [26] Reliability Test System Task Force, "The IEEE reliability test system- 1996," *IEEE Trans. Power Syst.*, vol. 14, no. 3, pp. 1010–1020, Aug. 1999.
  - [27] A. Gholami, T. Shekari, F. Aminifar, and M. Shahidehpour, "Microgrid Scheduling with Uncertainty: The Quest for Resilience," *IEEE Trans. Smart Grid*, vol. 7, no. 6, pp. 2849– 2858, 2016.
  - [28] Nordic Electricity Market, available online: [www.nordpool.com](http://www.nordpool.com), [accessed on 15, Oct. 2018].
  - [29] 'The General Algebraic Modeling System (GAMS) Software', online available at: <http://www.gams.com>, [accessed on 15 September 2016]