



Vaasan yliopisto
UNIVERSITY OF VAASA

OSUVA Open
Science

This is a self-archived – parallel published version of this article in the publication archive of the University of Vaasa. It might differ from the original.

Strategic bidding of virtual power plant in energy markets: A bi-level multiobjective approach

Author(s): Shafiekhani, Morteza; Badri, Ali; Shafie-khah, Miadreza; Catalão, João P.S.

Title: Strategic bidding of virtual power plant in energy markets: A bi-level multiobjective approach

Year: 2019

Version: Accepted manuscript

Copyright © 2019 Elsevier. This manuscript version is made available under the Creative Commons Attribution–NonCommercial–NoDerivatives 4.0 International (CC BY–NC–ND 4.0) license, <https://creativecommons.org/licenses/by-nc-nd/4.0/>

Please cite the original version:

Shafiekhani, M., Badri, A., Shafie-khah, M. & Catalão, J. P. S. (2019). Strategic bidding of virtual power plant in energy markets: A bi-level multiobjective approach. *International Journal of Electrical Power & Energy Systems* 113, 208-219.
<https://doi.org/10.1016/j.ijepes.2019.05.023>

Strategic Bidding of Virtual Power Plant in Energy Markets: A Bi-Level Multi-Objective Approach

Morteza Shafiekhani^a, Ali Badri^{a,*}, Miadreza Shafie-khah^b, João P. S. Catalão^{c,*}

^a Faculty of Electrical Engineering, Shahid Rajaei Teacher Training University, Tehran, Iran

^b School of Technology and Innovations, University of Vaasa, 65200 Vaasa, Finland

^c Faculty of Engineering of the University of Porto and INESC TEC, Porto 4200-465, Portugal

*First corresponding author: Ali Badri, ali.badri@sru.ac.ir

*Second corresponding author: João P. S. Catalão, catalao@fe.up.pt

Abstract:

This paper represents a model for finding the strategic bidding equilibrium of a virtual power plant in a joint energy and regulation market in the presence of rivals. A bi-level mathematical program with equilibrium constraints (MPEC) is represented for modeling the behavior of each producer. The upper level deals with profit maximization of each strategic unit and the lower level encompasses social welfare maximization. This is the first objective of the presented model. Power transfer distribution factors (PTDFs) are employed to model transmission constraints. The proposed bi-level problem is converted to a traceable mixed integer linear programming problem using duality theory and Karush-Kahn-Tucker (KKT) optimization conditions. Simultaneous solution of all MPECs forms an equilibrium problem with equilibrium constraints (EPEC). Solving the resulting EPEC using diagonalization algorithm and game theory, a market Nash equilibrium is obtained. Another goal is to solve the bi-level problem in a bi-objective way using the augmented epsilon constraint method, which maximizes the profit and minimizes the emissions of virtual power plant units. The proposed model is tested on a standard IEEE-24 bus system and the results indicate that, at the equilibrium point, the profit of a virtual power plant and GenCo will be less than in the initial state.

Keywords: Virtual power plant, optimal bidding, market equilibrium, energy market, regulation

Nomenclature

Indices

t	Index for time period
b	index for demand/generation block
g	Index for generation units of VPP
w	Index for wind scenario
τ	Index for rivals' scenarios
m and n	Index for buses
il	Index for interruptible load

r	Index for rival
k	Index for line
d	Index for demand
o	Index for slack bus
q, q'	Index for players

Constants

$\lambda_{g,b,t}^{VPP}$	Marginal cost of b th block of unit g in VPP in period t
$\tau_{t,n}^{Bal}$	Balancing market price in bus n in period t
$R_g^{VPP,up}$	Ramp up rate for unit g in VPP
$R_g^{VPP,down}$	Ramp down rate for unit g in VPP
$\lambda_{r,b,t}^C$	Marginal cost of b th block of strategic conventional unit r in period t
$\lambda_{d,b,t}^D$	Marginal cost of b th block of d th demand in period t
$\lambda_{r,b,t}^R$	Marginal cost of b th block of r th rival in period t
$\lambda_{il,t}^{IL}$	Price of il th interruptible load in period t
$P_{t,w}^{wind}$	Wind power generation in scenario w of period t
$\pi_{t,w}$	Probability of scenario w in period t
$\theta_{\tau,t}$	Probability of scenario τ in period t
v_{aw}	Average wind speed in scenario w
P_{Rated}	Rated power of wind unit
v_{ci}	Cut-in wind speed
v_r	Rated wind speed
v_{co}	Cut-out wind speed
N_y	Maximum iteration number
$upreg$	Up regulation market price
$dnreg$	Down regulation market price
MUP_g^{VPP}	Minimum up time of unit g in VPP
MDN_g^{VPP}	Minimum down time of unit g in VPP
SUC_g^{VPP}	Start-up cost of unit g in VPP

Variables

P_t^{VPPDA}	Power cleared for VPP in day-ahead market in period t
$P_{g,b,t}^{VPP}$	Power produced by b th block of unit g in VPP in period t
$\lambda_{n,t}$	Market clearing price of bus n in period t
P_t^{up}	Power purchased in up regulation market in period t
P_t^{dn}	Power sold in down regulation market in period t
$P_{il,t}^{IL}$	Interruptible load amount in period t
σ_t^{VPP}	Offered price of VPP in period t
$P_{r,b,t}^C$	Power produced by b th block of strategic conventional unit r in period t
$P_{d,b,t}^D$	Power consumed by b th block of d th demand in period t

$P_{r,b,t,\tau}^R$	Power produced by b th block of r th rival in scenario τ of period t
P_q^{ny}	The aggregated value of the q th strategic unit in iteration ny
$\alpha_{g,t}^{VPP}$	Binary variable, 1 if unit is on, 0 otherwise
$\beta_{g,t}^{VPP}$	Binary variable, 1 if unit starts up
$\gamma_{g,t}^{VPP}$	Binary variable, 1 if unit shuts down
μ_t^{VPPmin}	Dual variable related to minimum production of VPP in period t
μ_t^{VPPmax}	Dual variable related to maximum production of VPP in period t
$\mu_{r,b,t}^{Rmin}$	Dual variable related to minimum production of b th block of r th rival in period t
$\mu_{r,b,t}^{Rmax}$	Dual variable related to maximum production of b th block of r th rival in period t
$\mu_{d,b,t}^{Dmin}$	Dual variable related to minimum production of b th block of d th demand in period t
$\mu_{d,b,t}^{Dmax}$	Dual variable related to maximum production of b th block of d th demand in period t

1 Introduction

Nowadays, increased use of fossil fuels and related environmental issues are among major concern in the world [1]. In recent years, renewable energy resources have been used to address this issue. However, these resources have in turn some problems due to their intermittent energy output that would be a great challenge for power system operation and corresponding owners. In order to address the above concerns virtual power plants (VPPs) are introduced. The concept of virtual power plant as multidimensional heterogeneous entity is based on integration of a number of dispersed units and making use of their aggregated capacities. According to FENIX project, a VPP aggregates the capacities of several distribution energy resources (DERs), which can provide distinct performance characteristics associated with each DER. The virtual power plant can also make contracts in the wholesale market and provide services to the system operator. An important feature of the virtual power plant is its ability to participate in the energy market. Thus VPP owners can move toward maximizing their profits by determining optimal bidding strategies. The VPP in this paper includes traditional units, renewable units, interruptible loads and consumers, which acts as a single entity in the wholesale electricity market, and its aim is making all components visible and achieving the most profit. In this point of view, the concept of VPP is similar to the local electricity market (LEM) because the LEM can serve as an ancillary services provider, reducing the burden on balancing market required for meeting power demand. It opens doors for the interactive grid and customer participation. In the LEM concept, the benefits of local power generation, storage and demand response all cooperate together and the peer-to-peer model enables the participation of all participants of the market [2, 3].

1.1 Literature review

Technical literature can be categorized into four categories. The first category, refers to the papers that have implemented the optimal bidding strategy of either conventional or renewable units as price maker and price taker in the form of single-level models. The second category includes the papers that have presented optimal bidding strategy in the bi-level models, some of them incorporate virtual power plants in the model. The third

category is dedicated to those papers that use the game theory to execute their bidding and obtain the equilibrium point. Finally, multi-objective papers are provided as the forth category in this literature review.

In the first category, the optimal bidding strategy is presented in the form of a single level model, In this regard there are many studies for bidding strategy of generation units in terms of conventional power plants [4-6] and renewable resources . In [7] definite and random offering strategies of a price taker wind producer in a pool market are evaluated. A bidding framework is provided in [8] for a wind generation that strategically participates in a day ahead energy market and offers its intermittent output via the regulation market. The uncertainties related to wind generation and regulation market prices are modeled as a set of scenarios. A bidding strategy for a price maker wind producer is presented in [9] in which just bids in the regulation market to achieve the maximum profit. None of the above papers has carried out the optimal bidding problem in the form of a virtual power plant in the presence of rivals. Furthermore, multi-objective optimization is not used.

In the second category bi-level modeling is employed for decision making. A bi-level modeling for optimal bidding strategy of a strategic wind turbine is represented in [10] in which upper level is to maximize unit profit while the lower level deals with social welfare maximization that can be replaced by Karush-Kahn-Tucker (KKT) optimization conditions. A number of studies have been implemented to investigate VPP optimal bidding strategy problem. A two-stage mixed integer linear programming model for a bidding strategy of a VPP in both day ahead and real-time markets is presented in [11]. The VPP consists of dispatchable units and storage devices as well. Reference [12] presents a bi-level stochastic decision making framework for VPP in a joint day ahead and regulation market considering a novel demand response scheme. A three-stage bi-level optimization model is provided in [13] to determine the bidding strategy of a commercial VPP in a day ahead market in the presence of stochastic behaviors of rivals. The VPP consists of wind farms, storage devices and residential/commercial consumers. The above-mentioned papers have not studied the equilibrium point in the presence of rivals and multi-objective models.

In the third category game theory is used for optimal bidding strategy of producers. The equilibrium problem with equilibrium constraints (EPEC) [14] is used to model the interaction of the generation units in electricity markets. Market Nash equilibrium among large-scale generation companies in oligopolistic power markets is investigated in [15, 16]. In [17], the impact of wind power integration on market equilibrium is proposed. An oligopoly market including day ahead and real-time markets is considered for this purpose. A three-stage Stackelberg game for coordinated management of renewable and conventional energy resources is provided in [18]. A combination of game theory and big data is employed to address this coordination. Reference [19] presents a Cournot game model to investigate the impact of wind power volatility on energy market prices and bidding of big generation companies. A Stochastic programming model to obtain generation optimal bidding strategy in both energy and reserve markets is represented in [20] in which game theory is applied to obtain reserve price between wind and conventional producers. Strategic behaviors of wind power plants with supply function game in both short-term and midterm electricity markets are studied in [21] and results are compared with price taker wind producers. An optimization framework for the strategic offering of wind power producers in presence of demand response resources are presented in [22, 23] in which incomplete information game theory is used to obtain market equilibria among wind producers. Ref [24] proposes a bi-level framework to study the impact of wind units in energy and reserve markets. Game theory is used to obtain market Nash

equilibrium among wind units. The proposed model is based on deterministic wind forecasts and does not consider the regulation market. In none of the above papers the equilibrium point of the virtual power plant has been studied in the presence of strategic rivals, and none of them has used multi-level or multi-objective optimization.

Some references have used heuristic and metaheuristic methods to solve the problem of equilibrium and game theory. Reference [25] proposes a new method that uses the combination of particle swarm optimization (PSO) and simulated annealing (SA) to predict the bidding strategy of Generating Companies (GenCos) in an electricity market where they have incomplete information about their rivals. In this paper a computational intelligence technique is introduced that can be used to solve the Nash optimization problem. This procedure, is based on the PSO algorithm, which uses SA method to avoid being trapped in local minima or maxima and improve the velocity function of particles. Reference [26] presents a new strategic bidding optimization technique which applies bi-level programming and swarm intelligence. In this paper, a general multileader-one-follower nonlinear bi-level (MLNB) optimization concept and related definitions are proposed based on the generalized Nash equilibrium, then a particle-swarm-optimization-based algorithm is developed to solve the MLNB model. A game problem may have only one Nash equilibrium, multiple Nash equilibria, or none at all. Lack of the Nash equilibrium is contributed to system constraints that cause the discontinuity in a strategic producer's optimal behavior to other strategic producer's bids [27, 28]. Meanwhile, binding constraints in a power system could also be responsible for the existence of multiple Nash equilibria. One of the most common strategies in the literature for attempting to find an equilibrium is diagonalization. This is a variant of the Gauss-Seidel method for numerical solution of simultaneous equations.

Reference [29] presents an equilibrium problem with equilibrium constraints (EPEC) that models interactions between the merchant DR aggregator and the merchant ES investor in a competitive electricity market. The proposed EPEC is solved using the diagonalization method on an ISO New England testbed with a prospective renewable generation portfolio and different techno-economic parameters of prospective DR and ES technologies. Reference [30] proposes a model to find the equilibria in the short-term electricity market with large scale wind power penetration. The Nash equilibria of the electricity market are obtained by solving the EPEC using the diagonalization algorithm.

Reference [31] has shown that this algorithm can have a pure solution in some cases, but it's not guaranteed to respond to all cases. The reference [32] has also shown that prices in a competitive solution reach the single equilibrium point via the diagonalization algorithm. In reference [33], first, the combined energy and reserve markets are considered, and the Nash equilibrium points are determined. Then, the bidding strategies for each GenCo at these points will be presented. The bids for the energy and 10 min spinning reserve (TMSR) markets are separated in the second stage, and again, the bidding strategies for each GenCo for the two separated markets will be demonstrated.

In recent years, reducing greenhouse gaseous emission and increasing investors' profits have become more highlighted. Therefore, a solution that solely minimizes the total scheduling costs or maximizes the overall profit may not be appropriate for real power systems. Therefore, the multi-objective framework is used in many papers such as [34] and [35] to minimize emissions and costs simultaneously, that is the forth category of our

literature review. None of the papers devoted to solving multi-objective problems has incorporated multi-level models and has not studied game theory to reach the market equilibrium point.

1.2 Motivations and contributions

Considering existing research, it can be seen that no comprehensive study has been carried out for obtaining market equilibrium in the presence of virtual power plants. This paper represents a model for finding strategic bidding equilibria for a VPP containing conventional units, wind power and interruptible loads in a joint energy and regulation market in the presence of conventional generation companies as rival producers. A day-ahead energy market is assumed that positive and negative unbalances due to wind generation are settled in the regulation market. Subsequently, a bi-level mathematical framework is represented for modeling behavior of each strategic producer in which the upper level deals with profit maximization of each strategic producer and the lower level encompasses social welfare maximization considering transmission constraints. Power transfer distribution factors (PTDFs) are employed to model transmission constraints. The proposed bi-level problem is converted to a traceable mixed integer linear programming problem using duality theory and Karush-Kahn-Tucker (KKT) optimization conditions. Simultaneous solution of all MPECs forms an equilibrium problem with equilibrium constraints (EPEC). Solving resulting EPEC using diagonalization algorithm and game theory, market Nash equilibrium is obtained. Finally, the augmented epsilon constraint method has been used to solve the two-objective problem in the above model. This method has been used to maximize the profit of linearized model and minimize the emission of the virtual power plant units.

In the EPEC model, it is expected that the profit of each strategic producer (VPP and GenCo) will be reduced at the point of market equilibrium due to the imposition of game conditions. In the market structure, it is expected that by increasing the production of wind units in virtual power plant, the amount of its cleared power is lower than the generated power that causes down regulation power.

The main contributions of this study are briefly as below:

- 1) Application of EPEC and diagonalization algorithm to obtain strategic bidding equilibrium of a virtual power plant in the presence of other strategic rivals.
- 2) A Bi-level multi-objective model is presented to maximize profit and minimize the emission in virtual power plants based on the augmented epsilon constraint method.
- 3) Power transfer distribution factor formulation is also used for modeling transmission network which is more efficient than DC power flow, especially in large power systems.

The organization of the paper is as follows. The problem formulation is presented in section 2. The case studies and simulation results are discussed in section 3 and section 4 provides the conclusion.

2. Problem Formulation

A bi-level mathematical framework is proposed for optimal bidding strategy of a VPP in which upper level (UL) deals with VPP profit maximization in the day ahead and regulation markets, as shown in Equation (1). In this Equation the first term is VPP revenue from selling energy to the day-ahead energy market, multiplying VPP

aggregated output and day-ahead market clearing price as shown in Equation (2). The second term is the cost/revenue of VPP due to energy purchased/sold in up/down regulation markets, due to the intermittency of wind power output. The costs associated with interruptible loads are represented in the third term and finally the fourth term indicates VPP operation and start-up costs as provided in Equation (3). Energy balance equation is represented in Equation (4) that states aggregated energy produced by VPP conventional units, wind power and traded in up/down regulation market should be equal to VPP clearing energy in day-ahead market. Equations (5) and (6) enforce unit ramping limits and Equations (7), (8) show minimum up and minimum down unit constraints, respectively.

Maximize UL

$$\sum_t VPPR(t) - \sum_{t,n} \tau_{t,n}^{Bal} (upreg \times P_t^{up} - dnreg \times P_t^{dn}) - \sum_{il,t} P_{il,t}^{IL} \lambda_{il,t}^{IL} - \sum_t VPPC(t) \quad (1)$$

$$VPPR(t) = \lambda_{n,t} \times P_t^{VPPDA} \quad (2)$$

$$VPPC(t) = \sum_{g,b} \lambda_{g,b,t}^{VPP} P_{g,b,t}^{VPP} + \sum_g SUC_g^{VPP} \beta_{g,t}^{VPP} \quad (3)$$

$$P_t^{VPPDA} = \sum_{g,b} P_{g,b,t}^{VPP} + \sum_w \pi_{t,w} P_{t,w}^{wind} + \sum_{il,t} P_{il,t}^{IL} + P_t^{up} - P_t^{dn} \quad (4)$$

$$\sum_b P_{g,b,t+1}^{VPP} - \sum_b P_{g,b,t}^{VPP} \leq R_g^{VPP,up}, \forall t < T, \forall g \quad (5)$$

$$\sum_b P_{g,b,t}^{VPP} - \sum_b P_{g,b,t+1}^{VPP} \leq R_g^{VPP,down}, \forall t < T, \forall g \quad (6)$$

$$\sum_{t=1}^{MUP} \alpha_{g,t+1}^{VPP} - 1 \geq MUP_g^{VPP}, \forall \beta_{g,t}^{VPP} = 1 \quad (7)$$

$$\sum_{t=1}^{MDN} 1 - \alpha_{g,t+1}^{VPP} \geq MDN_g^{VPP}, \forall \gamma_{g,t}^{VPP} = 1 \quad (8)$$

The optimization variables of the UL problem are the variables in the set $UL = \{VPPR(t), P_t^{up}, P_t^{dn}, P_{il,t}^{IL}, VPPC(t), \lambda_{n,t}, P_t^{VPPDA}, \beta_{g,t}^{VPP}, \alpha_{g,t}^{VPP}, \gamma_{g,t}^{VPP}\}$. The Weibull probability distribution function [22] is used to model wind speed as shown in Equation (9). In this Equation, k is the shape parameter, C is scale of the shape and v is wind speed. The information about related parameters and wind speed are provided in [36].

$$f_{wind}(v) = \frac{k}{c} \left(\frac{v}{c}\right)^{k-1} \exp\left(-\left(\frac{v}{c}\right)^k\right), \quad 0 < v < \infty \quad (9)$$

Based on Weibull function 10 scenarios are produced for hourly wind speeds and accordingly, hourly wind outputs are determined based on Equation (10).

$$P_{v_{aw}}^{wind} = \begin{cases} 0 & 0 \leq v_{aw} \leq v_{ci} \\ P_{Rated} \times \frac{(v_{aw} - v_{ci})}{(v_r - v_{ci})} & v_{ci} \leq v_{aw} \leq v_r \\ P_{Rated} & v_r \leq v_{aw} \leq v_{co} \\ 0 & v_{co} \leq v_{aw} \end{cases} \quad (10)$$

2.1 MPEC model for a single producer bidding strategy

As shown in Equation (11), lower level (LL) problem represents a market clearing mechanism by maximizing revenue from supplying demand minus total cost of energy offered by VPP and all other power producers, entitled social welfare. It is assumed that there is an incomplete information game in which rivals' behaviors are modeled via the normal probability distribution function as shown in Fig. 1. Subsequently, Equation (12) provides system load balance at each bus. The boundaries of the blocks offered by power producers and demands as well as corresponding dual variables are described in Equations (13) -(15). Equation (16) imposes capacity constraints on power transmission lines by means of PTDF model.

Maximize LL

$$\sum_{d,b,t} \lambda_{d,b,t}^D P_{d,b,t}^D - \sigma_t^{VPP} P_t^{VPPDA} - \sum_{r,b,t} \lambda_{r,b,t}^R \sum_{\tau} \theta_{\tau,t} P_{r,b,t,\tau}^R \quad (11)$$

$$P_t^{VPPDA} + \sum_{r,b,\tau} \theta_{\tau,t} P_{r,b,t,\tau}^R - \sum_{d,b} P_{d,b,t}^D = 0: \lambda_n, \forall n, \forall t \quad (12)$$

$$0 \leq P_t^{VPPDA} \leq P_t^{VPPDA \max}: \mu_t^{VPP \min}, \mu_t^{VPP \max}, \forall t \quad (13)$$

$$0 \leq P_{r,b,t,\tau}^R \leq P_{r,b,t,\tau}^{R \max}: \mu_{r,b,t,\tau}^{R \min}, \mu_{r,b,t,\tau}^{R \max}, \forall r, \forall b, \forall t \quad (14)$$

$$0 \leq P_{d,b,t}^D \leq P_{d,b,t}^{D \max}: \mu_{d,b,t}^{D \min}, \mu_{d,b,t}^{D \max}, \forall d, \forall b, \forall t \quad (15)$$

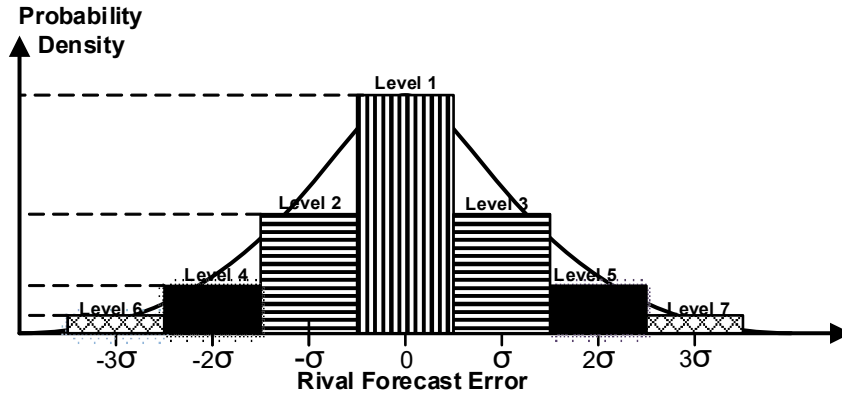

Figure 1: Normal probability distribution function of rivals' behaviors

The dual variables related to upper and lower limits are also indicated. Accordingly, locational marginal prices are obtained by duality variables of the second order problem, i.e., $\lambda_{o,t}$, $\mu_{k,t}^{\max}$ and $\mu_{k,t}^{\min}$ as shown in Equation (17). The statement S_{mo}^k shows PTDF matrix of the network.

$$-f_k^{\max} \leq \sum_{m \in M} S_{mo}^k \left\{ P_t^{VPPDA} + \sum_{r,b,\tau} \theta_{\tau,t} P_{r,b,t,\tau}^R - \sum_{d,b} P_{d,b,t}^D \right\} \leq f_k^{\max}, \forall t, \mu_{k,t}^{\min}, \mu_{k,t}^{\max} \quad (16)$$

$$\lambda_{m,t} = \lambda_{o,t} - \sum_{k \in K} S_{mo}^k \{ \mu_{k,t}^{\max} - \mu_{k,t}^{\min} \}, \forall t, \forall m \quad (17)$$

The optimization variables of the LL problem are the variables in the set $LL = \{P_{d,b,t}^D, P_{r,b,t,\tau}^R, \mu_t^{VPP \min}, \mu_t^{VPP \max}, \mu_{r,b,t,\tau}^{R \min}, \mu_{r,b,t,\tau}^{R \max}, \mu_{d,b,t}^{D \min}, \mu_{d,b,t}^{D \max}, \mu_{k,t}^{\min}, \mu_{k,t}^{\max}, u_t^{\min}, u_{r,b,t}^{\min}, u_{d,b,t}^{\min}\}$

$\{u_{d,b,t}^{max}, u_t^{max}, u_{r,b,t}^{max}, u_{d,b,t}^{min}, u_{k,t}^{max}, u_{k,t}^{min}\}$. Alongside the VPP, other strategic conventional units, entitled GenCos are assumed to be able to bid to the market as strategic producers. In this case the upper level of the problem will be converted to Equation (18), while the lower level is unchanged.

Maximize UL

$$\sum_{r,b,t} \lambda_{n,t} P_{r,b,t}^C - \sum_{r,b,t} \lambda_{r,b,t}^C P_{r,b,t}^C \quad (18)$$

In which the first and second terms represent the revenue and incurred cost of the GenCo, respectively. Note that these units are considered as VPP rivals as indicated in this Equation.

The represented bi-level model is nonlinear for the product of two variables $\lambda_{n,t}$ and P_t^{VPPDA} in the upper level that is linearized by strong duality theory and KKT optimality condition [8]. On the other hand, the nonlinear constraints in complementary conditions must be rewritten with an equivalent linear form using Fortuny-Amat transformation method [37]. Employing strong duality theory and KKT conditions the nonlinear optimization model is converted to a mathematical programming with equilibrium constraints as indicated in Equations (19) – (53).

Maximize UL ∪ LL

$$f_1 = \left[\sum_{d,b,t} \lambda_{d,b,t}^D P_{d,b,t}^D - \sum_{t,n} \tau_{t,n}^{Bal} (upreg \times P_t^{up} - dnreg \times P_t^{dn}) - \sum_t VPPC(t) - \sum_{i,t} P_{i,t}^{IL} \lambda_{i,t}^{IL} \right. \\ \left. - \sum_{r,b,t} \lambda_{r,b,t}^R \sum_{\tau} \theta_{\tau,t} P_{r,b,t,\tau}^R - \sum_{r,b,t} \mu_{g,b,t}^{Rmax} P_{r,b,t}^{Rmax} - \sum_{d,b,t} \mu_{g,b,t}^{Dmax} P_{d,b,t}^{Dmax} - \sum_{k,t} f_k^{max} \mu_{k,t}^{max} \right. \\ \left. - \sum_{k,t} f_k^{max} \mu_{k,t}^{min} \right] \quad (19)$$

$$\sum_{m \in M} S_{mo}^k \left\{ P_t^{VPPDA} + \sum_{r,b,\tau} \theta_{\tau,t} P_{r,b,t,\tau}^R - \sum_{d,b} P_{d,b,t}^D \right\} + f_k^{max} \leq (1 - u_{k,t}^{min}) M_k^{max}, \forall m, \forall t \quad (20)$$

$$- \sum_{m \in M} S_{mo}^k \left\{ P_t^{VPPDA} + \sum_{r,b,\tau} \theta_{\tau,t} P_{r,b,t,\tau}^R - \sum_{d,b} P_{d,b,t}^D \right\} + f_k^{max} \leq (1 - u_{k,t}^{max}) M_k^{max}, \forall m, \forall t \quad (21)$$

$$P_t^{VPPDA} \geq 0, \forall t \quad (22)$$

$$P_{d,b,t}^D \geq 0, \forall d, \forall b, \forall t \quad (23)$$

$$P_{r,b,t,\tau}^R \geq 0, \forall r, \forall b, \forall t, \forall \tau \quad (24)$$

$$\mu_t^{VPPmin} \geq 0, \forall t \quad (25)$$

$$\mu_{r,b,t}^{Rmin} \geq 0, \forall r, \forall b, \forall t \quad (26)$$

$$\mu_{d,b,t}^{Dmin} \geq 0, \forall d, \forall b, \forall t \quad (27)$$

$$\mu_t^{VPPmin} \leq M_{\varphi}^{max} u_t^{min}, \forall t \quad (28)$$

$$\mu_{r,b,t}^{Rmin} \leq M_{\zeta}^{max} u_{r,b,t}^{min}, \forall r, \forall b, \forall t \quad (29)$$

$$\mu_{d,b,t}^{Dmin} \leq M_{\eta}^{max} u_{d,b,t}^{min}, \forall d, \forall b, \forall t \quad (30)$$

$$P_t^{VPPDA} \leq P_t^{VPPmax}, \forall t \quad (31)$$

$$P_{r,b,t,\tau}^R \leq P_{r,b,t}^{Rmax}, \forall r, \forall b, \forall t, \forall \tau \quad (32)$$

$$P_{d,b,t}^D \leq P_{d,b,t}^{Dmax}, \forall d, \forall b, \forall t \quad (33)$$

$$\mu_t^{VPPmax} \geq 0, \forall t \quad (34)$$

$$\mu_{r,b,t}^{Rmax} \geq 0, \forall r, \forall b, \forall t \quad (35)$$

$$\mu_{d,b,t}^{Dmax} \geq 0, \forall d, \forall b, \forall t \quad (36)$$

$$\mu_{d,b,t}^{Dmax} \leq M_{\eta}^{max} u_{d,b,t}^{max}, \forall d, \forall b, \forall t \quad (37)$$

$$\mu_t^{VPPmax} \leq M_{\varphi}^{max} u_t^{max}, \forall t \quad (38)$$

$$\mu_{r,b,t}^{Rmax} \leq M_{\zeta}^{max} u_{r,b,t}^{max}, \forall r, \forall b, \forall t \quad (39)$$

$$P_{d,b,t}^D \leq M_{\eta}^{max} (1 - u_{d,b,t}^{min}), \forall d, \forall b, \forall t \quad (40)$$

$$P_t^{VPP} \leq M_{\varphi}^{max} (1 - u_t^{min}), \forall t \quad (41)$$

$$P_{r,b,t,\tau}^R \leq M_{\zeta}^{max} (1 - u_{r,b,t}^{min}), \forall r, \forall b, \forall t, \forall \tau \quad (42)$$

$$P_{d,b,t}^{Dmax} - P_{d,b,t}^D \leq M_{\eta}^{max} (1 - u_{d,b,t}^{max}), \forall d, \forall b, \forall t \quad (43)$$

$$P_t^{VPPmax} - P_t^{VPPDA} \leq M_{\varphi}^{max} (1 - u_t^{max}), \forall t \quad (44)$$

$$P_{r,b,t}^{Rmax} - P_{r,b,t,\tau}^R \leq M_{\zeta}^{max} (1 - u_{r,b,t}^{max}), \forall r, \forall b, \forall t, \forall \tau \quad (45)$$

$$\mu_{k,t}^{max} \geq 0, \forall m, \forall t \quad (46)$$

$$\mu_{k,t}^{min} \geq 0, \forall m, \forall t \quad (47)$$

$$\mu_{k,t}^{max} \leq u_{k,t}^{max} M_k^{max}, \forall m, \forall t \quad (48)$$

$$\mu_{k,t}^{min} \leq u_{k,t}^{min} M_k^{max}, \forall m, \forall t \quad (49)$$

$$\lambda_{r,b,t}^R - \lambda_{n,t} + \mu_{r,b,t}^{Rmax} - \mu_{r,b,t}^{Rmin} + \sum_{k \in K} S_{mo}^k \{ \mu_{k,t}^{max} - \mu_{k,t}^{min} \} = 0, \forall r, \forall b, \forall t \quad (50)$$

$$\sigma^{VPP} - \lambda_{n,t} + \mu_t^{VPPmax} - \mu_t^{VPPmin} + \sum_{k \in K} S_{mo}^k \{ \mu_{k,t}^{max} - \mu_{k,t}^{min} \} = 0, \forall t \quad (51)$$

$$-\lambda_{d,b,t}^D + \lambda_{n,t} + \mu_{g,b,t}^{Dmax} - \mu_{g,b,t}^{Dmin} - \sum_{k \in K} S_{mo}^k \{ \mu_{k,t}^{max} - \mu_{k,t}^{min} \} = 0, \forall d, \forall b, \forall t \quad (52)$$

$$u_n^{min}, u_n^{max}, u_{r,b,t}^{min}, u_{r,b,t}^{max}, u_t^{min}, u_t^{max}, \\ u_{d,b,t}^{min}, u_{d,b,t}^{max}, u_{k,t}^{min}, u_{k,t}^{max} \in \{0,1\} \quad (53)$$

The emission of the virtual power plant units is modeled according to the linear equation (54). The total production of all steps of the virtual power plant units is multiplied by a constant multiplier to obtain the emission coefficients of the units are shown in Table 1 [38].

Minimize emission

$$f_2 = \text{emissionconstant}(g, \alpha E) * \sum_b P_{g,b,t}^{VPP} \quad (54)$$

Similarly, the resulting MPEC model for other strategic rivals, except VPP is obtained as Equation (55).

Maximize $UL \cup LL$

$$\begin{aligned} & \sum_{d,b,t} \lambda_{d,b,t}^D P_{d,b,t}^D - \sum_{r,b,t} \lambda_{r,b,t}^C P_{r,b,t}^C - \sum_{r,b,t} \lambda_{r,b,t}^R \sum_{\tau} \theta_{\tau,t} P_{r,b,t,\tau}^R - \sum_{r,b,t} \mu_{r,b,t}^{Rmax} P_{r,b,t}^{Rmax} - \sum_{d,b,t} \mu_{d,b,t}^{Dmax} P_{d,b,t}^{Dmax} \\ & - \sum_{k,t} f_k^{max} \mu_{k,t}^{max} - \sum_{k,t} f_k^{max} \mu_{k,t}^{min} \end{aligned} \quad (55)$$

As shown in Equation (53), the indicated values are binary variables. The big M method is used to linearize the models in which $M_{\zeta}^{max}, M_{\varphi}^{max}, M_{\eta}^{max}, M_k^{max}$ are large enough values [8].

Table 1: Data for the VPP and rival units

	VPP(g1)	VPP(g2)	VPP(g3)	R1	R2	R3	R4	R5	R6	R7
$P_1^{max}(MW)$	25	15.2	25	54.25	140	68.95	68.95	140	54.25	140
$P_2^{max}(MW)$	25	22.8	25	38.75	97.5	49.25	49.25	97.5	38.75	97.5
$P_3^{max}(MW)$	20	22.8	20	31	52.5	39.4	39.4	52.5	31	52.5
$P_4^{max}(MW)$	20	15.2	20	31	70	39.4	39.4	70	31	70
$\lambda_1(\$/MWh)$	18.60	11.46	18.60	9.92	19.2	10.08	10.08	19.2	9.92	19.2
$\lambda_2(\$/MWh)$	20.03	11.96	20.03	10.25	20.32	10.66	10.66	20.32	10.25	20.32
$\lambda_3(\$/MWh)$	67.21	13.89	67.21	10.68	21.22	11.09	11.09	21.22	10.68	21.22
$\lambda_4(\$/MWh)$	22.72	15.97	22.72	11.26	22.13	11.72	11.72	22.13	11.26	22.13
$R^{up}(MW)$	210	60	210	90	120	90	90	120	90	120
$R^{Down}(MW)$	210	60	210	90	120	90	90	120	90	120
$SUC(\$)$	715.2	218.5	715.2	156	1149	862.5	862.5	1149	156	1149
$MUT(h)$	2	2	2	2	2	2	2	2	2	2
$MDT(h)$	2	2	2	2	2	2	2	2	2	2
$emissioncon. (lb/MWh)$	1.2	1.1342	1.2							

2.2 EPEC model for multi producers bidding equilibria

As seen the formulation of bi-level model is converted to an MPEC model using linearization and KKT optimality constraints. In order to obtain market equilibria among the whole strategic producers, all MPEC models should be solved simultaneously. The EPEC model is derived from combination of the MPECs as shown in Fig. 2. This is a multi-leader-single-follower problem, in which the VPP and GenCo are different leaders and a market clearing process is a common follower [30, 39].

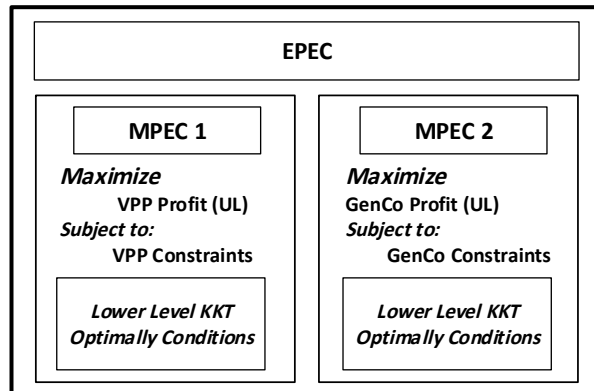

Figure 2: EPEC model

The diagonalization algorithm is used to solve EPEC problem. Fig. 3 represents the proposed flowchart for this purpose. As shown, the MPEC problem is solved for all strategic producers, assuming other rival behaviors are estimated based on mathematical expectation. For this purpose, it is assumed that each rival behaves based on a normal probability distribution function with specific mean and standard variation amounts. For example, in the first iteration MPEC is solved for the virtual power plant, assuming that the generated quantities of the GenCos are constant and some values will be obtained for the virtual power plant productions. Then the MPEC problem is solved for GenCo, assuming predetermined productions of the virtual power plant. This process continues until the maximum number of iterations are reaches or a convergence is obtained. This process continues while all strategic biddings reach a convergence point called market Nash equilibria.

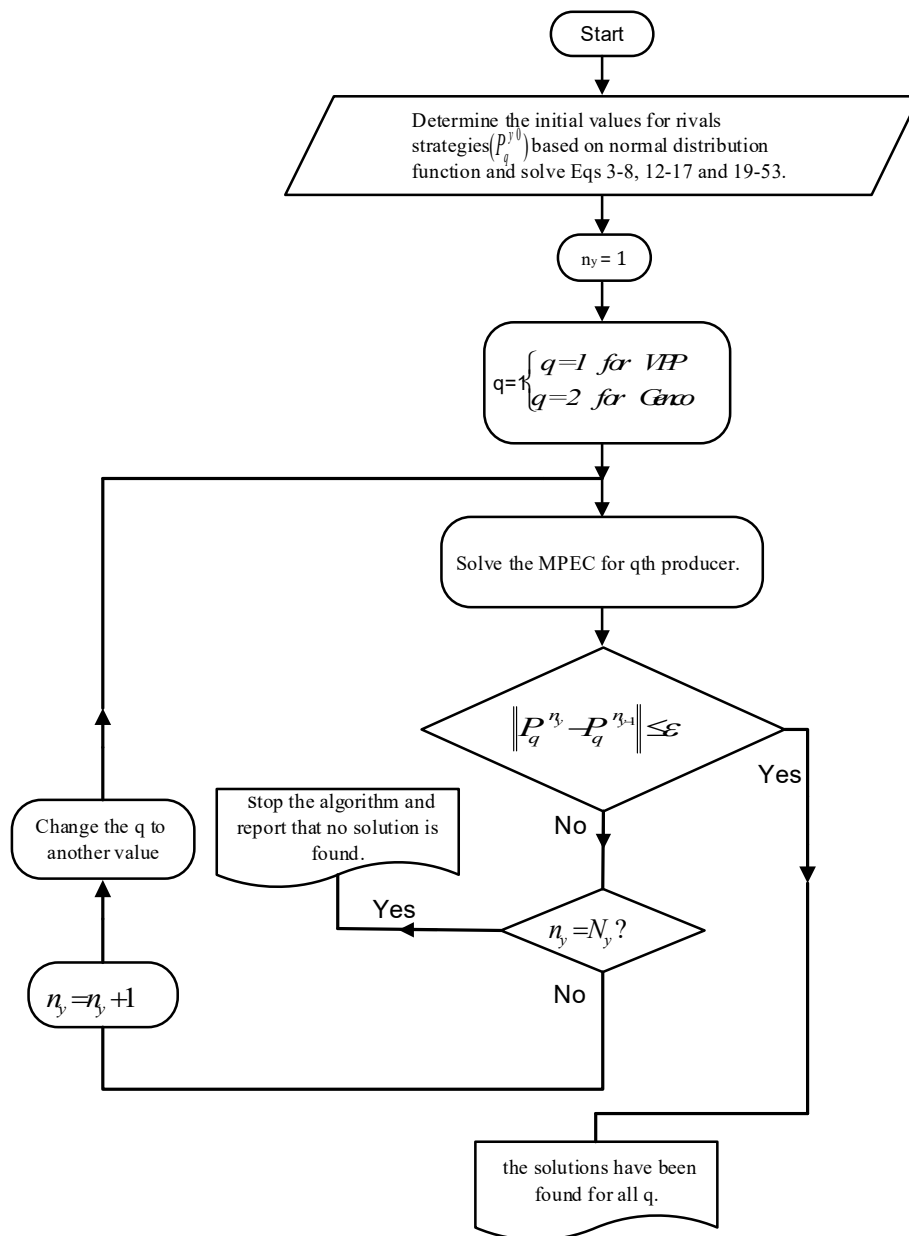

Figure 3: Diagonalization algorithm flowchart

2.3 Multi-objective optimization of profit and emission

The multi-objective optimization format of a problem with the epsilon constraint method is as follows.

$$\begin{aligned} & \text{Min } f_1(x) \\ & \text{subject to } f_2(x) \leq e_2 \end{aligned} \quad (56)$$

For the two-objective problem of profit and emission of strategic units, $f_1(x)$ serves as the main objective function and other goal (here $f_2(x)$) as a constraint in the problem. Furthermore, x is an array of decision variables, which in this problem is generation power of units.

2.3.1 Augmented epsilon constraint method

In the epsilon constraint method, the first objective function is considered as the main objective function, and the second to n-th objectives are limited to a maximum of e_i . By changing the value, there are various answers that may not be efficient. To avoid weak solutions and accelerate the whole process by avoiding excessive repetitions, we use the augmented epsilon constraint method as follows. In the augmented epsilon constraint method, there are two steps to obtain the optimal solution. In the first step, efficient solutions are produced. In the second step, decision making process chooses an appropriate solution between the efficient solutions produced in the previous step. The formulation of the multi-objective problem for solving the multi-objective problem of profit and emission is as follows.

$$\min \left[\text{obj}(1) + \text{dir}(1) \times r_1 \sum_{i=2}^3 \frac{S_i}{r_i} \right] \quad (57)$$

$$\text{obj}(i) + \text{dir}(i) \times S_i = e_i \quad (58)$$

$\text{obj}(1)$ shows the main objective function. If $\text{dir}(1)$ is equal to 1, the goal is to maximize the objective function, and if $\text{dir}(1)$ is -1, then the objective function must be minimized. S_i and r_i are the auxiliary non-negative variables and the objective function range, respectively. By changing e_i , efficient solutions to the problem are generated. When applying the augmented epsilon constraint method, the scope of each objective function must first be determined. Then using the values of the range of each objective function, 10 Pareto solutions are obtained.

2.3.2 Decision making method

After solving the problem and obtaining all of the Pareto solutions, the decision maker should choose one of Pareto's answers as the final solution to the problem, taking into account the priorities and the different uses of Pareto's answers. For this purpose, the proposed method for choosing the best answer is to use a fuzzy approach with a linear membership function for the decision maker. The membership function of the proposed fuzzy method is defined as equations (59) and (60), which are used respectively for maximization and minimization. The best and worst amounts of each objective function are arranged in the order of the ideal point f_n^u and nadir point f_n^{SN} . In these equations, f_n^r shows value of the objective function f_n in the r-th Pareto solution number and μ_n^r is the membership function f_n in the r-th Pareto solution number. μ_n^r actually represents the optimality of the objective function in the r-th Pareto solution number. The general membership function of the r-th Pareto solution is called μ^r , which is calculated according to (61), where ω_n is the importance factor of the n-th

objective functions. The values of the importance coefficients are determined by the decision maker. For example, if economic issues are the top priority for the decision maker, higher value is assigned to f_1 and if emission is more important, a lower value is assigned to f_1 [34, 35]. These coefficients for the profit and emission functions are 2 and 1, respectively.

Maximization:

$$\mu_n^r = \begin{cases} 0 & f_n^r \leq f_n^{SN} \\ \frac{f_n^r - f_n^{SN}}{f_n^u - f_n^{SN}} & f_n^{SN} \leq f_n^r \leq f_n^u \\ 1 & f_n^r \geq f_n^u \end{cases} \quad (59)$$

$$n = 1$$

Minimization:

$$\mu_n^r = \begin{cases} 1 & f_n^r \leq f_n^u \\ \frac{f_n^{SN} - f_n^r}{f_n^{SN} - f_n^u} & f_n^u \leq f_n^r \leq f_n^{SN} \\ 0 & f_n^r \geq f_n^{SN} \end{cases} \quad (60)$$

$$n = 2$$

$$\mu_r = \frac{\sum_{n=1}^P \omega_n \cdot \mu_n^r}{\sum_{n=1}^P \omega_n} \quad (61)$$

3. Case Study

3.1 Single-objective case

The proposed framework is applied to a 24-bus IEEE test system as shown in Fig. 4 [38]. The 24 bus test system used in this paper is the largest network among existing VPP decision making studies [40-46].

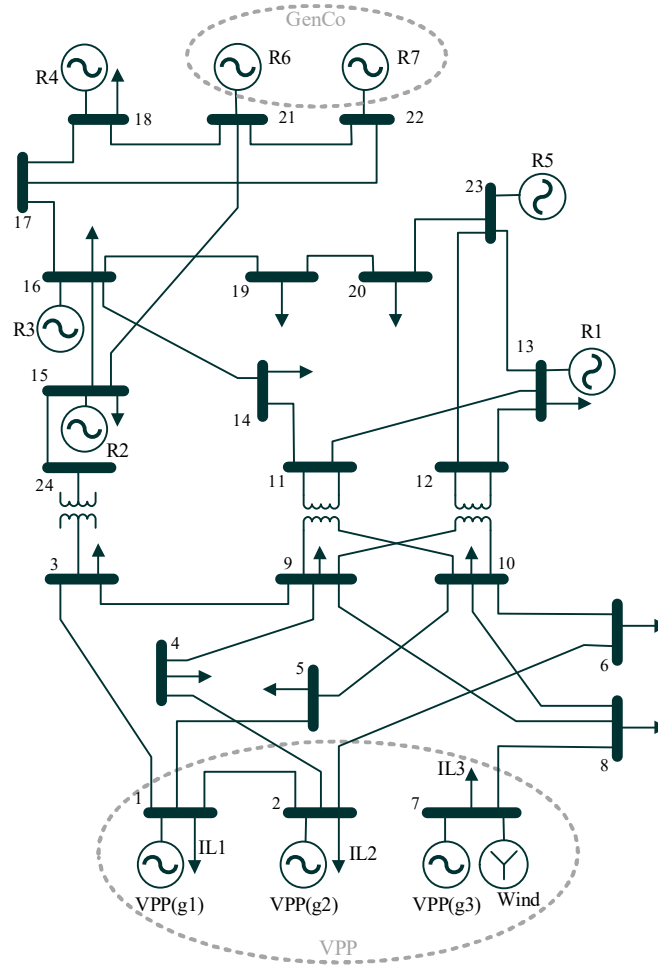

Figure 4: 24-bus test system

It is assumed that buses 1, 2 and 7 are owned by the VPP. The VPP also owns a wind turbine in bus 7 and interruptible loads in buses 1, 2 and 7 with maximum 40% curtailments and interruption cost of 15, 10 and 15 \$/MWh respectively. Values of cut in, rated and cut out wind speeds are 5, 15 and 45 m/s, respectively. Other producers entitled R1-R7 are considered as rivals that are located in buses 11, 15, 16, 18, 22, 21 and 23 among which R6 and R7 are from a GenCo that is considered as a strategic rival for the VPP. All production units are assumed to bid with normal distribution probability. For each rival, 7 scenarios with mean and standard deviations are produced. The mean values of producers' bidding blocks are represented in Table 1 with standard deviation of 3.5 [38]. The information of loads' bidding blocks is provided in reference [38].

Fig. 5 shows the relationship between the virtual power plant as well as other producers and loads in the market. Thick arrows indicate the flows of power, while the dashed line arrows indicate blocks of offers and bids. The flow of power for VPP is bidirectional, because it can be either a producer or a consumer.

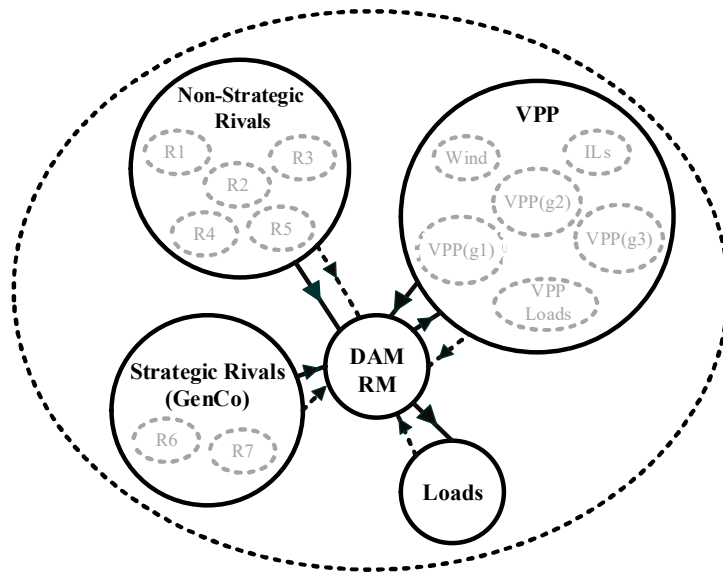

Figure 5: VPP and other players' framework, DAM: Day-Ahead Market, RM: Regulation Market

Using the proposed diagonalization algorithm, the market equilibrium point among strategic producers (VPP and the GenCo (R6, R7)) is obtained. Fig. 6 shows the market clearing price at Nash equilibrium point. The regulation market prices are set 30% higher/lower than market clearing price for up/down regulation markets, respectively. Here it is assumed that no congestion occurs in transmission lines, thus the market clearing prices are uniform for all period of times.

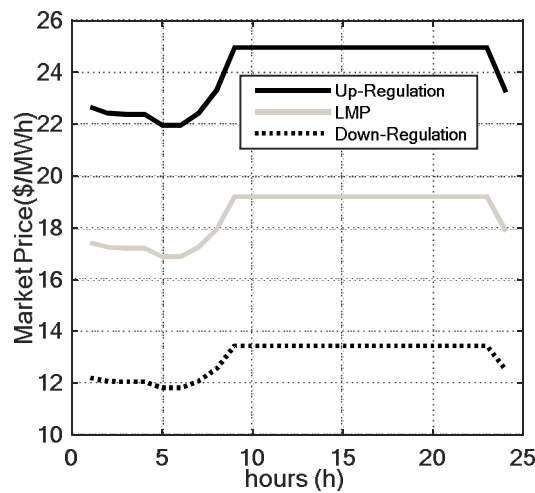

Figure 6: Market clearing price and up/down regulation price

Fig. 7 shows the profit values of VPP and GenCo while reaching the equilibrium point. For both players the profits are descending, indicating that they are forced to react in response to their rival strategies, while reaching the equilibrium point that is profitable for all strategic producers. As previously stated in the EPEC case in each iteration of the MPEC problem, the values of the previous strategic producer are considered constant. As shown

the final profits of the strategic producers are less than their initial amounts. This is due to the imposition of other rivals that leads to the divergence from their optimal point.

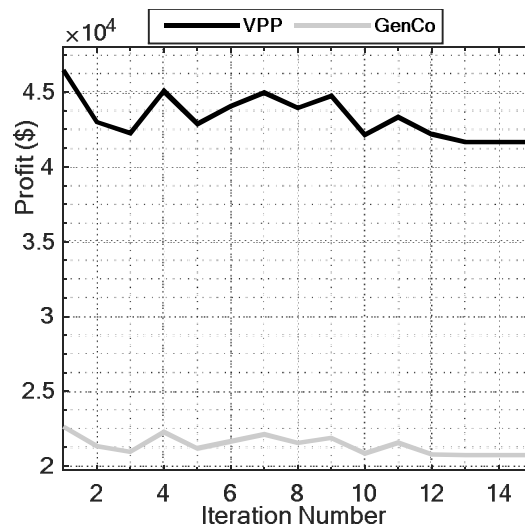

Figure 7: Profit of strategic producers

Fig. 8 illustrates interruptible load amounts imposed by VPP at buses 1, 2 and 7. In early and closing hours of scheduling period we can see the highest load curtailments. This can be interpreted by market price values in these periods. Since market clearing prices in mid hours are high, it would be beneficial for the VPP to produce and serve costumers' loads. On the other hand, in other periods, lower market prices lead to lower VPP contributions, while costumers have still their bidding blocks accepted that results in higher interruptible loads in these periods. Here, IL1, IL2 and IL3 are assigned to buses 1, 2, and 7, respectively.

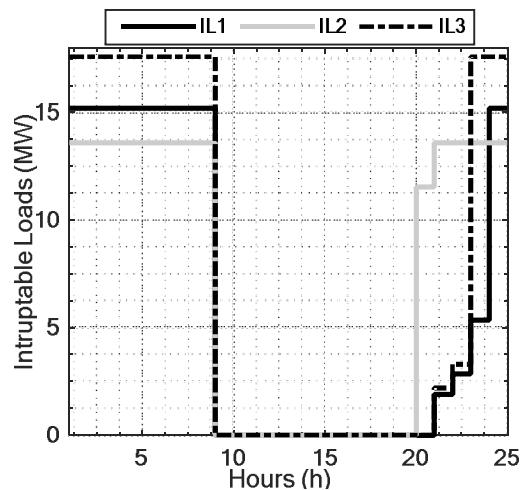

Figure 8: Interruptible loads power

The generation output of VPP is illustrated in Fig. 9. As can be seen, in most hours, VPP participates in the day-ahead market with its second unit (VPP (g2)), since VPP (g1) and VPP (g3) are relatively more expensive units. However, in mid-hours (9 to 19) due to high wind power productions and also contribution of R7, the quote of VPP (g2) is reduced in market equilibrium.

Maximum wind contributions in mid-hours result in high energy clearing amounts for the VPP during these hours. This in turn leads to some mismatches between cleared and real production values for VPP. As illustrated in Fig. 9 the VPP's cleared powers are less than its real production outputs within hours 10 to 18. Therefore, VPP has inevitably spent some of its power in downward regulation. In other words, it has sold its surplus power in the downward regulation market.

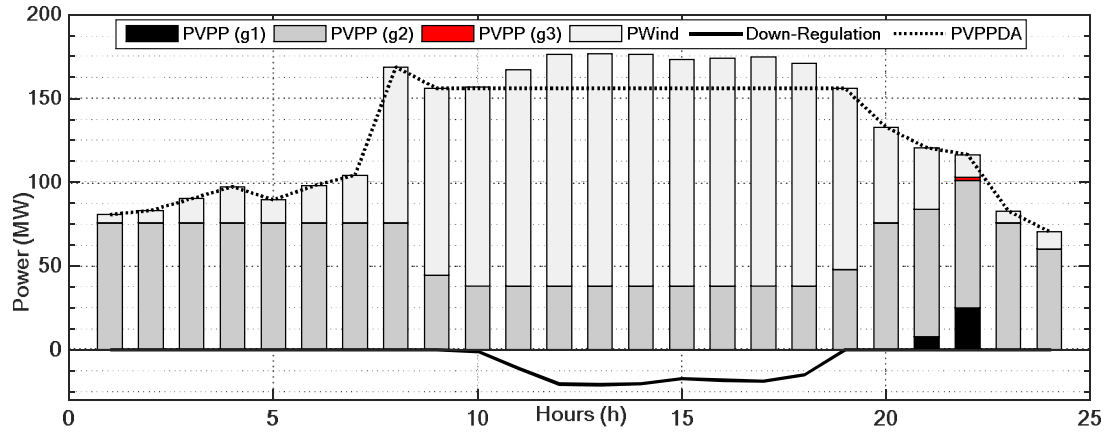

Figure 9: Bidding equilibria of virtual power plant

The bidding blocks of other rivals (strategic (GenCo) and non-strategic) are depicted in Fig. 10. As can be understood from Table 1, R1, R3 and R4 have relatively low marginal prices, such that their bidding prices are always lower than market clearing prices, thus they have produced their entire blocks. Their most expensive bidding block is lower than the market's lowest clearing price. For example, the most expensive bidding blocks are 11.26 and 11.72, respectively, while the lowest clearing price is at hours 5 and 6, which is 16.886. On the contrary R2, R5 are identical and more expensive rivals such that their bidding prices always exceed market clearing prices, thus they have no contributions at all. The cheapest bidding block is 19.2, which is larger or equal to the highest market clearing price. Unit 6 of GenCo bids inexpensive blocks, so as Fig. 10 shows, it has the most production for almost all hours. However, since unit 7 has expensive blocks it only produces in mid-hours when the market clearing price is high (19.2) and does not produce in the early and the late hours.

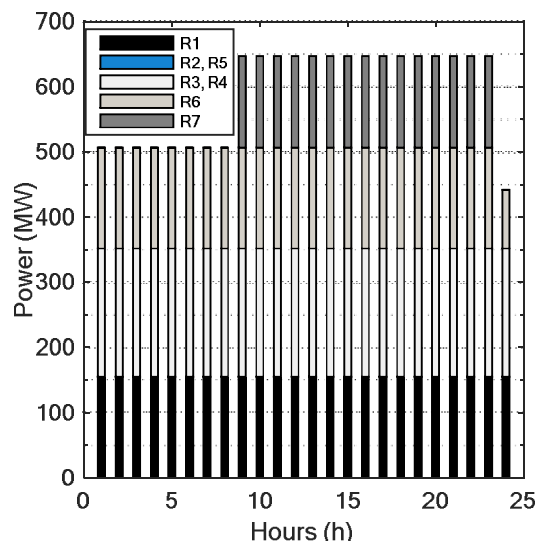

Figure 10: Bidding equilibria of rivals

Three scenarios have been investigated and compared to understand the effect of flexible wind unit and interruptible loads on the model.

Scenario 1: The wind unit and the interruptible loads are in the VPP.

Scenario 2: The wind unit is in the VPP, but the interruptible loads are not in the VPP.

Scenario 3: Wind and interruptible loads are not in the VPP.

In the first scenario, the wind and interruptible loads are in the virtual power plant, the output of the virtual power plant units is obtained according to Fig. 11. In the second scenario, as shown in the figure, the production of the first and third units of the virtual power plant have been affected and their production has increased. In the third scenario, the amount of virtual power plant generation has changed a lot. The lack of wind unit power has caused a very high production of all three units of the virtual power plant to compensate for the lack of wind unit.

The profit values in these three scenarios are 41662.7 \$, 39790.73 \$ and 9511.96 \$, respectively. It is clear that eliminating interruptible loads leads to slight changes (decreases) in VPP profit. It is due to low capacities of these loads in the VPP. However, eliminating wind unit results in significant reduction in VPP profit.

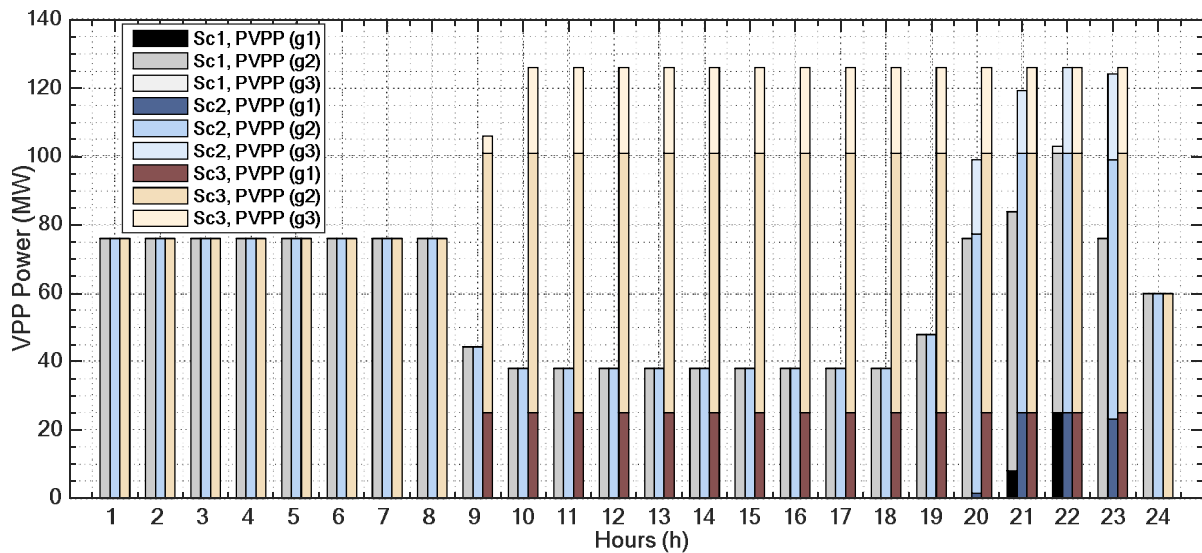

Figure 11: Impact of Wind Unit and interruptible Loads on the Production of Virtual Power Plant units

Finally, to understand the impact of market equilibrium mechanism on players bidding strategies and market characteristics, a study has been implemented in case that the VPP is a single strategic producer acting as a monopole price maker participant. In this case all other producers including GenCo (R6, R7) are considered as nonstrategic rivals. Unlike, previous EPEC modeling, here an MPEC framework is solved. Fig. 12 illustrates the VPP optimal bidding strategy and other nonstrategic contributions. In comparison to Fig. 9 it is shown that VPP has participated with its more expensive units, VPP (g1) and VPP (g3) that in turn diminishes the social welfare. Although VPP (g1) and VPP (g3) are identical; however due to the existence of wind power in bus 7, the contribution of VPP (g3) is lower than VPP (g1). In this case VPP participates in the downward regulation market as well in hours 15, 16 and 17. It is noticeable that the amount of VPP profit in this case is 46486.5\$ that is much higher than its market equilibrium profit (41662.7 \$) (See Figure 7).

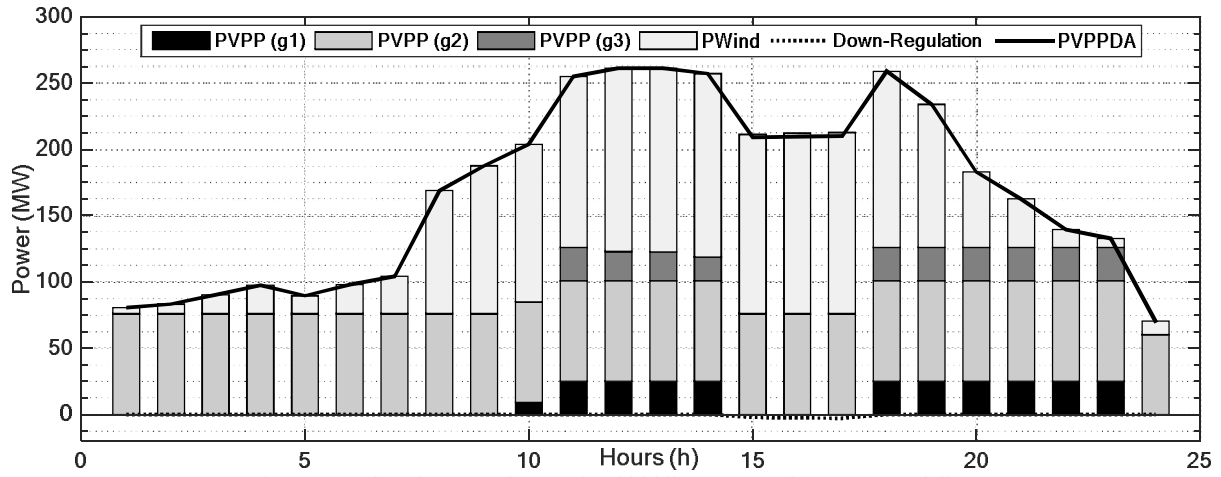

Figure 12: Virtual power plant optimal bidding strategy in MPEC modeling

The productions of other producers are shown in Fig. 13, as shown in this figure, amounts of power generated by R7 are widely different. More precisely, one can say that in EPEC model, R7 produces with its first block in some hours, since GenCo (R6, R7) is a strategic player. However, R7 has no contribution in MPEC modeling. In fact, VPP as a single strategic producer compensates the shortages by means of all its power units and wind power. Similarly, the production of other producers is dependent on corresponding bidding prices.

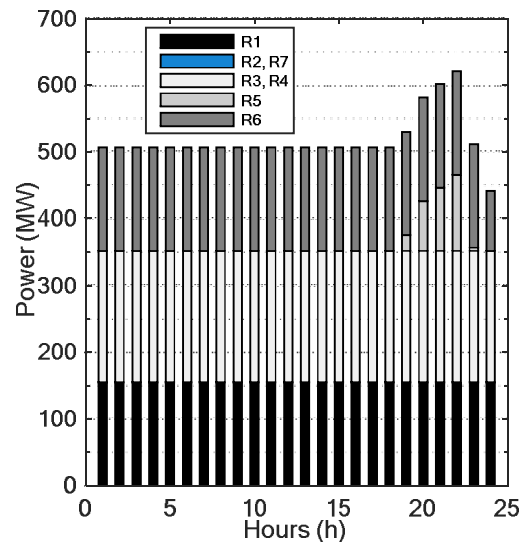

Figure 13: Other rivals optimal bidding strategy in MPEC modeling

3.2 Multi-objective case

In this case, the problem is solved in the two-objective method. For this purpose, two-objective functions are required. The first objective function is considered as the main objective function (f_1) and the gaseous emission is considered as a constraint or second objective function (f_2). Using equations (3) - (8), (12) - (17), (19) - (54) and (56) - (61), and with respect to the main objective function, the problem is solved in two-objective method. As shown in Fig. 14, the amount of emission is also increased by increasing the amount of profit, which one of the most important reasons of that is the increase in the production of virtual power plant units. To solve the problem using the augmented epsilon constraint method, the problem is first solved with a single-objective approach with consideration of profit. In this case the amounts of VPP profit and emission are 46486.5\$ and

2641.64lb, respectively. Then, the problem is solved in single-objective manner and only with respect to the emission objective function. In this case there is a significant decrease in the amount of emission, reaching 264.16lb. However, the profit is also decreased to 38685.1\$. Finally, the problem was solved by using the two-objective augmented epsilon constraint method, which resulted in a number of 10 Pareto solutions.

The fuzzy decision making method, as described above, is used to select the best solution from the Pareto solutions. As previously stated, in this paper, the importance of the profit objective function is considered to be twice of the emission objective function, so the fuzzy decision making method has chosen Pareto solutions number 2 as the best answer. In this case, the amount of VPP profit and emission would be 40,371.36\$ and 528.33lb, respectively.

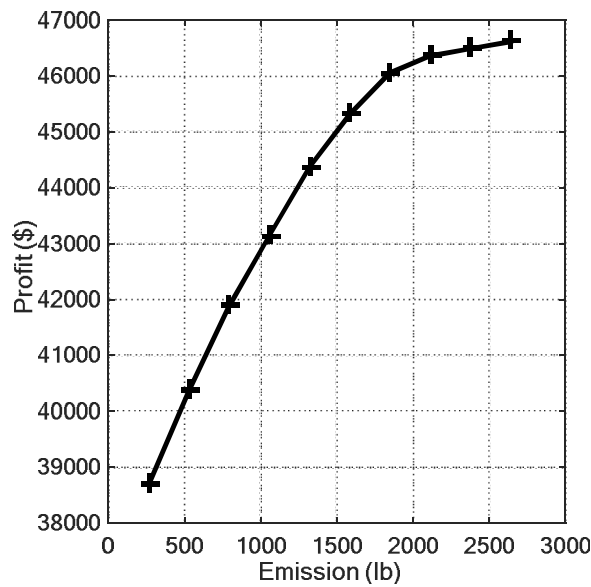

Figure 14: Pareto optimal solutions, the profit versus emission

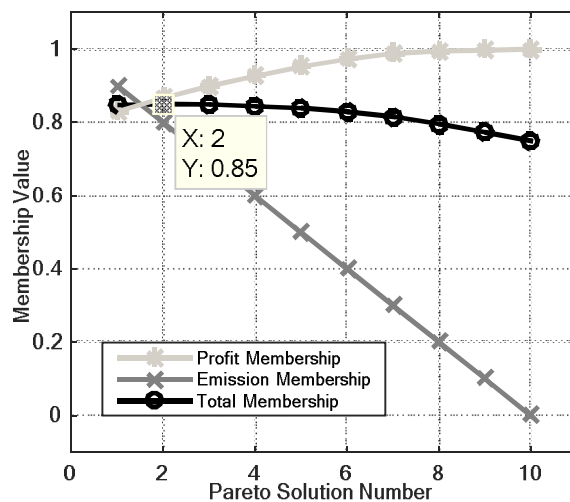

Figure 15: Variation of total membership, profit and emission functions versus Pareto optimal solutions

3.3 Test results on IEEE 57 bus test system

The model presented in this paper, was also implemented on a 57-bus test system [47]. At first, the PTDF matrix of the network was extracted, which is an 80×56 matrix. In this network, the virtual power plant has 4 conventional production units from PVPP(g1) to PVPP(g4), which are located in buses 1, 2, 3 and 6,

respectively. Units PVPP(g2) and PVPP(g4) have inexpensive bidding blocks and PVPP(g1) and PVPP(g3) have expensive bidding blocks. Wind Unit is located in bus 3. The virtual power plant also has interruptible loads in buses 1, 2 and 3. There are 10 rivals for the virtual power plant in this structure, shown with R1 to R10. Among these rivals, R2, R5, R7 and R9 have more expensive bidding blocks than the rest. There are 42 loads as well.

Fig. 16 shows the market clearing price. The transmission capacity of all the lines was within their permissible range, therefore no line congestion occurred, which is why the market price for all buses in the 24 hours was as shown in Fig. 16.

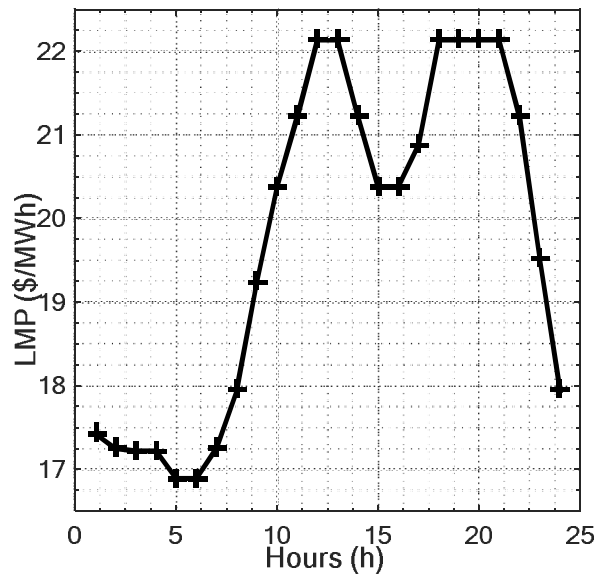

Figure 16: Market clearing price in 57-bus case

Fig. 17 illustrates the power production of the virtual power plant units, wind unit, clearing power of day ahead market and regulation power of virtual power plant. It is clear from Fig. 17 that similar to 24-bus test system, inexpensive units in the virtual power plant generate more power than expensive units. In mid-hours, due to large amount of wind generation, the amount of power generated by the virtual power plant is higher than its cleared power, so this excess power is presented in the regulation market. The PVPP(g3) produced less power than the PVPP(g1) unit. The main reason is that the wind unit is located in bus 3, so the power produced in this bus is very high and PVPP(g1) is less needed.

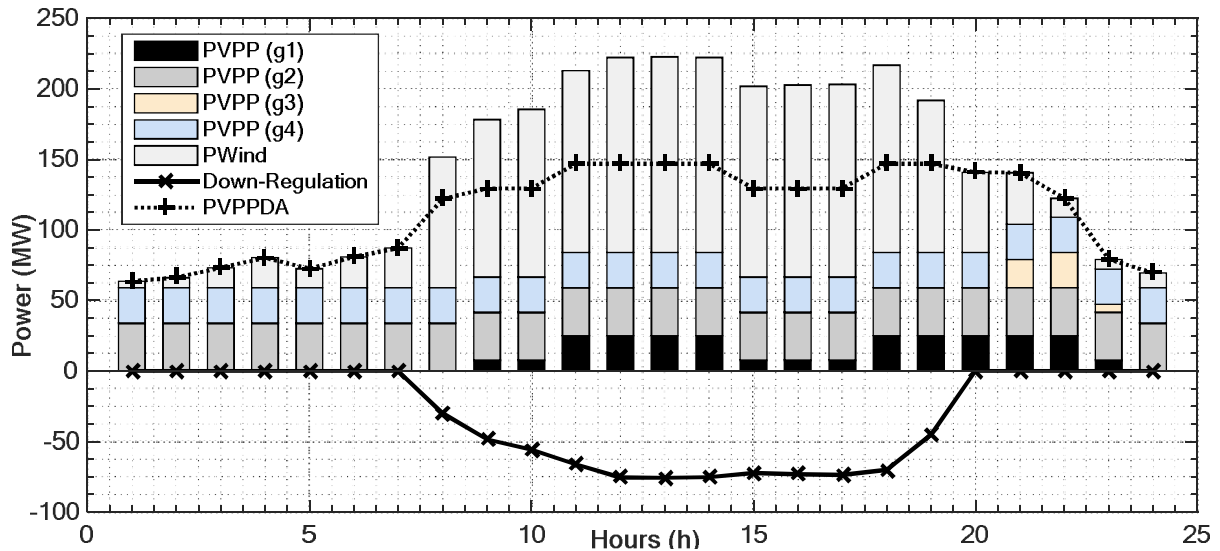

Figure 17: Virtual power plant optimal bidding strategy

The power production of rivals is shown in Fig. 18. In this figure, as in other figures in this paper, more expensive rivals (R2, R5, R7 and R9) produced only in mid-hours (9-23), which market clearing price is high, and does not have any production in other hours. Other rivals that are inexpensive, produce all time, since their most expensive bidding blocks are lower than the market price. This process is also visible on the 24-bus system.

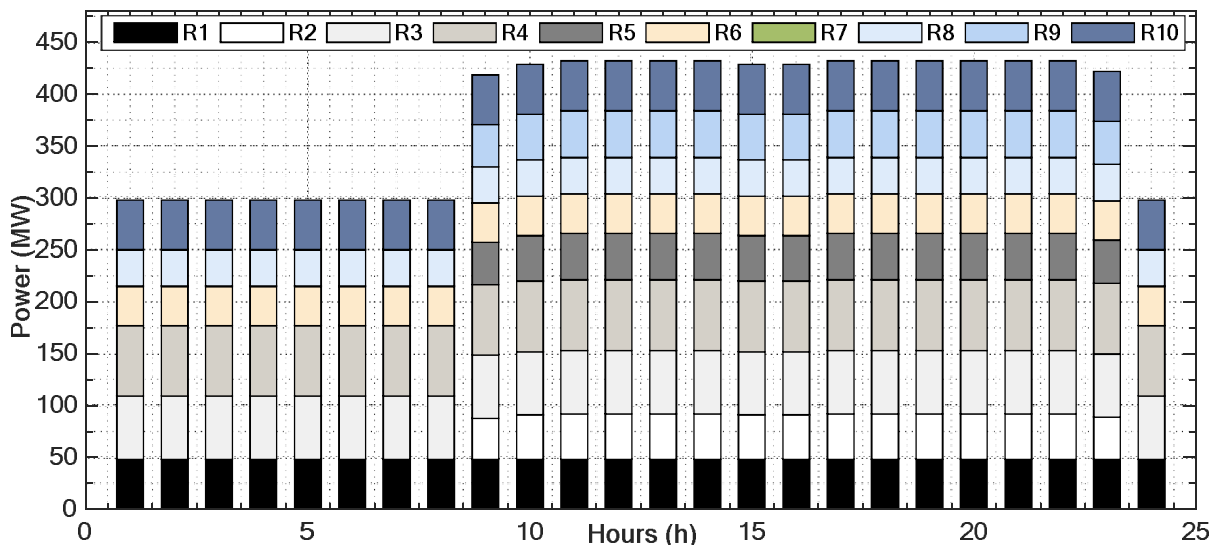

Figure 18: Rivals optimal bidding strategy

Table 2 illustrates the size of the optimization model and the associated execution time. The proposed model is simulated using CPLEX 12.1 in GAMS software [48]. All simulations are implemented on a laptop with core i7, 2.5 GHz CPU, and 6 GB of RAM.

Table 2: Execution time and size of the model

	Number of Equations	Single Variables	Discrete Variables	Execution Time
MPEC Model	43566	30909	11376	33.077 s
EPEC Model	72610	51515	18960	245.124 s
57-Bus Case (MPEC)	79619	58140	21528	181.59 s

4. Conclusion

This paper provided a method for the optimal strategic bidding of a virtual power plant, including conventional units, the wind unit and the interruptible loads along with other strategic rivals (GenCo) in the day-ahead and regulation markets. A bi-level mathematical program with equilibrium constraints (MPEC) is represented for modeling the behavior of each strategic producer (virtual power plant and GenCo) that is converted to a traceable mixed integer linear programming problem using duality theory and Karush-Kahn-Tucker (KKT) optimization conditions. Solving simultaneous MPEC problems, entitled EPEC, a Nash market equilibrium is obtained. The production of each wind unit is very effective on the bidding strategy of the virtual power plant, since the amount of virtual power plant production in the regulation market is directly related to its wind unit. The difference between the cleared power of the virtual power plant and its amount of produced power causes up and down regulation power. Reaching the equilibrium point is accompanied by reduction in the profit of all strategic producers (virtual power plant and GenCo), since in each iteration their production will be imposed by other rival reactions. Another contribution of this paper is solving the bi-level problem in a two-objective approach using the augmented epsilon constraint method, which aims to maximize the profit of the virtual power plant and minimize its emission. The results showed that in the two-objective case, the profit and emission values are more reasonable compared to the single-objective mode.

Acknowledgment

J.P.S. Catalão acknowledges the support by FEDER funds through COMPETE 2020 and by Portuguese funds through FCT, under POCI-01-0145-FEDER-029803 (02/SAICT/2017) and POCI-01-0145-FEDER-006961 (UID/EEA/50014/2019).

References

- [1] A. Colmenar-Santos, C. Reino-Rio, D. Borge-Diez, and E. Collado-Fernandez, "Distributed generation: A review of factors that can contribute most to achieve a scenario of DG units embedded in the new distribution networks," *Renewable Sustainable Energy Reviews*, vol. 59, pp. 1130-1148, 2016.
- [2] E. Mengelkamp, J. Gärttner, and C. Weinhardt, "Decentralizing energy systems through local energy markets: the LAMP-project," *Multikonferenz Wirtschaftsinformatik, MKWI*, pp. 924-930, 2018.
- [3] F. Teotia and R. Bhakar, "Local energy markets: Concept, design and operation," in *2016 National Power Systems Conference (NPSC)*, 2016: IEEE, pp. 1-6.
- [4] M. Tuffaha and J. T. Gravdahl, "Discrete state-space model to solve the unit commitment and economic dispatch problems," *Energy Systems*, vol. 8, no. 3, pp. 525-547, 2017.
- [5] A. Tavakoli *et al.*, "Self-scheduling of a Generating Company with an EV Load Aggregator under an Energy Exchange Strategy," *IEEE Transactions on Smart Grid*, 2018.

- [6] E. G. Kardakos, C. K. Simoglou, and A. G. Bakirtzis, "Optimal bidding strategy in transmission-constrained electricity markets," *Electric Power Systems Research*, vol. 109, pp. 141-149, 2014.
- [7] Y. Xiao, X. Wang, X. Wang, C. Dang, and M. Lu, "Behavior analysis of wind power producer in electricity market," *Applied energy*, vol. 171, pp. 325-335, 2016.
- [8] L. Baringo and A. J. Conejo, "Offering strategy of wind-power producer: A multi-stage risk-constrained approach," *IEEE Transactions on Power Systems*, vol. 31, no. 2, pp. 1420-1429, 2016.
- [9] M. Zugno, J. M. Morales, P. Pinson, and H. Madsen, "Pool strategy of a price-maker wind power producer," *IEEE Transactions on Power Systems*, vol. 28, no. 3, pp. 3440-3450, 2013.
- [10] T. Dai and W. Qiao, "Optimal bidding strategy of a strategic wind power producer in the short-term market," *IEEE Transactions on Sustainable Energy*, vol. 6, no. 3, pp. 707-719, 2015.
- [11] S. R. Dabbagh and M. K. Sheikh-El-Eslami, "Risk-based profit allocation to DERs integrated with a virtual power plant using cooperative Game theory," *Electric Power Systems Research*, vol. 121, pp. 368-378, 2015.
- [12] E. Ghorbankhani and A. Badri, "A bi-level stochastic framework for VPP decision making in a joint market considering a novel demand response scheme," *International Transactions on Electrical Energy Systems*, vol. 28, no. 1, p. e2473, 2018.
- [13] E. G. Kardakos, C. K. Simoglou, and A. G. Bakirtzis, "Optimal offering strategy of a virtual power plant: A stochastic bi-level approach," *IEEE Transactions on Smart Grid*, vol. 7, no. 2, pp. 794-806, 2016.
- [14] A. Fischer, M. Herrich, and K. Schönefeld, "Generalized Nash equilibrium problems-recent advances and challenges," *Pesquisa Operacional*, vol. 34, no. 3, pp. 521-558, 2014.
- [15] A. Badri and M. Rashidinejad, "Security constrained optimal bidding strategy of GenCos in day ahead oligopolistic power markets: a Cournot-based model," *Electrical Engineering*, vol. 95, no. 2, pp. 63-72, 2013.
- [16] I. Taheri, M. Rashidinejad, A. Badri, and A. Rahimi-Kian, "Analytical approach in computing nash equilibrium for oligopolistic competition of transmission-constrained GENCOs," *IEEE systems journal*, vol. 9, no. 4, pp. 1452-1462, 2015.
- [17] S. J. Kazempour and H. Zareipour, "Equilibria in an oligopolistic market with wind power production," *IEEE Transactions on Power Systems*, vol. 29, no. 2, pp. 686-697, 2014.
- [18] Z. Zhou *et al.*, "Game-theoretical energy management for energy Internet with big data-based renewable power forecasting," *IEEE Access*, vol. 5, pp. 5731-5746, 2017.
- [19] D. Chattopadhyay and T. Alpcan, "A game-theoretic analysis of wind generation variability on electricity markets," *IEEE Transactions on Power Systems*, vol. 29, no. 5, pp. 2069-2077, 2014.
- [20] M. S. Al-Swaiti, A. T. Al-Awami, and M. W. Khalid, "Co-optimized trading of wind-thermal-pumped storage system in energy and regulation markets," *Energy*, vol. 138, pp. 991-1005, 2017.
- [21] M. Banaei, M. O. Buygi, and H. Zareipour, "Impacts of strategic bidding of wind power producers on electricity markets," *IEEE Transactions on Power Systems*, vol. 31, no. 6, pp. 4544-4553, 2016.

- [22] M. Shafie-khah, E. Heydarian-Forushani, M. E. H. Golshan, M. P. Moghaddam, M. K. Sheikh-El-Eslami, and J. P. Catalão, "Strategic offering for a price-maker wind power producer in oligopoly markets considering demand response exchange," *IEEE Transactions on Industrial Informatics*, vol. 11, no. 6, pp. 1542-1553, 2015.
- [23] S. Martín, Y. Smeers, and J. A. Aguado, "A stochastic two settlement equilibrium model for electricity markets with wind generation," *IEEE Transactions on Power systems*, vol. 30, no. 1, pp. 233-245, 2015.
- [24] L. Exizidis, J. Kazempour, P. Pinson, Z. De Grève, and F. Vallée, "Impact of public aggregate wind forecasts on electricity market outcomes," *IEEE Transactions on Sustainable Energy*, vol. 8, no. 4, pp. 1394-1405, 2017.
- [25] S. Soleymani, "Bidding strategy of generation companies using PSO combined with SA method in the pay as bid markets," *International Journal of Electrical Power Energy Systems*, vol. 33, no. 7, pp. 1272-1278, 2011.
- [26] G. Zhang, G. Zhang, Y. Gao, and J. Lu, "Competitive strategic bidding optimization in electricity markets using bilevel programming and swarm technique," *IEEE Transactions on Industrial Electronics*, vol. 58, no. 6, pp. 2138-2146, 2011.
- [27] S. Soleymani, A. Ranjbar, and A. Shirani, "New approach to bidding strategies of generating companies in day ahead energy market," *Energy Conversion Management*, vol. 49, no. 6, pp. 1493-1499, 2008.
- [28] S. Khazeni, A. Sheikhi, M. Rayiati, S. Soleymani, and A. M. Ranjbar, "Retail Market Equilibrium in Multicarrier Energy Systems: A Game Theoretical Approach," *IEEE Systems Journal*, no. 99, pp. 1-10, 2018.
- [29] Y. Dvorkin, "Can merchant demand response affect investments in merchant energy storage?," *IEEE Transactions on Power Systems*, vol. 33, no. 3, pp. 2671-2683, 2018.
- [30] T. Dai and W. Qiao, "Finding equilibria in the pool-based electricity market with strategic wind power producers and network constraints," *IEEE Transactions on Power Systems*, vol. 32, no. 1, pp. 389-399, 2017.
- [31] B. F. Hobbs, C. B. Metzler, and J.-S. Pang, "Strategic gaming analysis for electric power systems: An MPEC approach," *IEEE transactions on power systems*, vol. 15, no. 2, pp. 638-645, 2000.
- [32] A. Ehrenmann, "Equilibrium problems with equilibrium constraints and their application to electricity markets," Doctoral dissertation, University of Cambridge, 2004.
- [33] S. Soleymani, A. Ranjbar, and A. Shirani, "New approach for strategic bidding of Gencos in energy and spinning reserve markets," *Energy conversion management*, vol. 48, no. 7, pp. 2044-2052, 2007.
- [34] N. G. Paterakis, M. Gibescu, A. G. Bakirtzis, and J. P. Catalão, "A multi-objective optimization approach to risk-constrained energy and reserve procurement using demand response," *IEEE Transactions on Power Systems*, vol. 33, no. 4, pp. 3940-3954, 2018.
- [35] H. Mavalizadeh, A. Ahmadi, F. H. Gandoman, P. Siano, and H. A. Shayanfar, "Multiobjective robust power system expansion planning considering generation units retirement," *IEEE Systems Journal*, vol. 12, no. 3, pp. 2664-2675, 2018.

- [36] A. Y. Saber and G. K. Venayagamoorthy, "Resource scheduling under uncertainty in a smart grid with renewables and plug-in vehicles," *IEEE systems journal*, vol. 6, no. 1, pp. 103-109, 2012.
- [37] J. Fortuny-Amat and B. McCarl, "A representation and economic interpretation of a two-level programming problem," *Journal of the operational Research Society*, vol. 32, no. 9, pp. 783-792, 1981.
- [38] C. Ruiz and A. J. Conejo, "Pool strategy of a producer with endogenous formation of locational marginal prices," *IEEE Transactions on Power Systems*, vol. 24, no. 4, pp. 1855-1866, 2009.
- [39] S. Leyffer and T. Munson, "Solving multi-leader–common-follower games," *Optimisation Methods & Software*, vol. 25, no. 4, pp. 601-623, 2010.
- [40] Y. Liu, M. Li, H. Lian, X. Tang, C. Liu, and C. Jiang, "Optimal dispatch of virtual power plant using interval and deterministic combined optimization," *International Journal of Electrical Power Energy Systems*, vol. 102, pp. 235-244, 2018.
- [41] M. Peik-Herfeh, H. Seifi, and M. Sheikh-El-Eslami, "Decision making of a virtual power plant under uncertainties for bidding in a day-ahead market using point estimate method," *International Journal of Electrical Power Energy Systems*, vol. 44, no. 1, pp. 88-98, 2013.
- [42] A. G. Zamani, A. Zakariazadeh, S. Jadid, and A. Kazemi, "Stochastic operational scheduling of distributed energy resources in a large scale virtual power plant," *International Journal of Electrical Power Energy Systems*, vol. 82, pp. 608-620, 2016.
- [43] M. K. Petersen, L. H. Hansen, J. Bendtsen, K. Edlund, and J. Stoustrup, "Heuristic optimization for the discrete virtual power plant dispatch problem," *IEEE Transactions on Smart Grid*, vol. 5, no. 6, pp. 2910-2918, 2014.
- [44] A. Baringo and L. Baringo, "A stochastic adaptive robust optimization approach for the offering strategy of a virtual power plant," *IEEE Transactions on Power Systems*, vol. 32, no. 5, pp. 3492-3504, 2017.
- [45] M. Giuntoli and D. Poli, "Optimized thermal and electrical scheduling of a large scale virtual power plant in the presence of energy storages," *IEEE Transactions on Smart Grid*, vol. 4, no. 2, pp. 942-955, 2013.
- [46] Y. Wang, "An adaptive importance sampling method for spinning reserve risk evaluation of generating systems incorporating virtual power plants," *IEEE Transactions on Power Systems*, vol. 33, no. 5, pp. 5082-5091, 2018.
- [47] M. Basu, "Multi-objective optimal reactive power dispatch using multi-objective differential evolution," *International Journal of Electrical Power Energy Systems*, vol. 82, pp. 213-224, 2016.
- [48] *GAMS Web page* [Online]. Available: www.gams.com.