



Vaasan yliopisto
UNIVERSITY OF VAASA

OSUVA Open
Science

This is a self-archived – parallel published version of this article in the publication archive of the University of Vaasa. It might differ from the original.

Optimal Operation of Distribution Networks through Clearing Local Day-ahead Energy Market

Author(s): Bahramara, Salah; Sheikahmadi, Pouria; Lotfi, Mohamed; Catalão, João P. S.; Santos, Sérgio F.; Shafie-khah, Miadreza

Title: Optimal Operation of Distribution Networks through Clearing Local Day-ahead Energy Market

Year: 2019

Version: Accepted manuscript

Copyright © 2019 IEEE. Personal use of this material is permitted. Permission from IEEE must be obtained for all other uses, in any current or future media, including reprinting/republishing this material for advertising or promotional purposes, creating new collective works, for resale or redistribution to servers or lists, or reuse of any copyrighted component of this work in other works.

Please cite the original version:

Bahramara, S., Sheikahmadi, P., Lotfi, M., Catalão, J. P. S., Santos, S. F. & Shafie-khah, M. (2019). Optimal Operation of Distribution Networks through Clearing Local Day-ahead Energy Market. In: *2019 IEEE Milan PowerTech*, 1-6.
<https://doi.org/10.1109/PTC.2019.8810836>

Optimal Operation of Distribution Networks through Clearing Local Day-ahead Energy Market

Salah Bahramara, Pouria Sheikahmadi
Higher Education Center of Eghlid,
Eghlid, Iran
a.nikoobakht@eghlid.ac.ir;
pouria.sheikahmadi@yahoo.com

Mohamed Lotfi, João P. S. Catalão
FEUP and INESC TEC,
4200-465 Porto, Portugal
mohd.f.lotfi@gmail.com;
catalao@fe.up.pt

Sérgio F. Santos
C-MAST/UBI,
Covilha,
Portugal
sdfsantos@gmail.com

Miadreza Shafie-khah
School of Technology
and Innovations
University of Vaasa
Vaasa, Finland
miadreza@gmail.com

Abstract—New energy market players such as micro-grid aggregators (MGA), distributed energy resource aggregators (DERA), and load aggregators (LAs) have all emerged to facilitate the integration of DERs into power systems. These players can participate in wholesale markets either individually or through distribution companies (Discos). In both cases, several operational challenges emerge for transmission system operators (TSOs) and distribution system operators (DSOs). Meanwhile, a transition is occurring from centralized wholesale markets into local energy markets (LEMs). A literature review shows that these LEMs are mostly modeled focusing on the coordination between DSOs and TSOs to meet demand in real-time operation using ancillary service markets and balancing markets. The main contribution of this paper is to model a local day-ahead energy market (LDEM) for optimal operation of a distribution network. This LDEM is cleared by the DSO with the aim of maximizing the social welfare of market players while satisfying the technical constraints of the network. To investigate the effectiveness of the proposed model, it is applied on the IEEE 33-bus network. Moreover, the effect of technical constraints of the network on the distribution locational marginal price (DLMP) is studied.

Index Terms—Distributed resources; Locational marginal price; distribution system operator; Local energy market.

NOMENCLATURE

Acronyms

<i>DN</i>	Distribution network
<i>Disco</i>	Distribution Company
<i>DSO</i>	Distribution system operator
<i>DER</i>	Distributed energy resources
<i>DG</i>	Distributed generator
<i>DR</i>	Demand response
<i>DA/RT</i>	Day-ahead/Real-time
<i>DMCP</i>	Distribution market clearing price
<i>DLMP</i>	Distribution locational marginal price
<i>Genco</i>	Generation company
<i>IL</i>	Interruptible load
<i>ISO/TSO</i>	Independent/Transmission system operator
<i>LEM/LDEM</i>	Local energy market/Local day-ahead EM
<i>LP</i>	Linear programming
<i>MG</i>	Micro grid
<i>RES</i>	Renewable energy sources
<i>R/C/I</i>	Residential / Commercial / Industrial
<i>R/C/I LA</i>	R/C/I - Load Aggregator

Indices and Sets

<i>b, B</i>	Index and set of energy block
<i>d, D</i>	Index and set of DN load consumption
<i>j, h</i>	Indices of DN buses
<i>k, K</i>	Index and set of voltage/current piecewise

n, N	Index and set of MG
t, T	Index and set of time period
Λ_j^{RD}	Set of residential loads located at bus j
Λ_j^{CD}	Set of commercial loads located at bus j
Λ_j^{ID}	Set of industrial loads located at bus j
Λ_j^{MG}	Set of MGs located at bus j
$Conj(j, h)$	Mapping of each bus h connected to bus j

Parameters

$C_{t,b}^{Ret}$	Bid price of retailer (\$/MWh)
$C_{t,b}^{RLA} / C_{t,b}^{CLA} / C_{t,b}^{ILA}$	Bids of RCI loads aggregators (\$/MWh)
$C_{t,n,b}^{sell-MG}$	Offer price of MGs (\$/MWh)
$C_{t,n,b}^{purchase-MG}$	Bid price of MGs (\$/MWh)
$\bar{I}_{i,j}^{DN}$	Upper/Lower limit of DN feeder current (kA)
$\frac{P_{j,h}^{flow}}{\bar{P}_{j,h}^{flow}} / \frac{P_{j,h}^{flow}}{\bar{P}_{j,h}^{flow}}$	Upper/Lower limit of voltage of DN bus (kV)
$\frac{P_{t,d}^{RD}}{\bar{P}_{t,d}^{RD}} / \frac{P_{t,d}^{CD}}{\bar{P}_{t,d}^{CD}} / \frac{P_{t,d}^{ID}}{\bar{P}_{t,d}^{ID}}$	Maximum RCI DN demand (MW)
$\frac{PB_{t,b}^{Ret}}{\bar{PB}_{t,b}^{Ret}}$	Maximum sold power / block by retailer (MW)
$\frac{PB_{n,b}^{sell-MG}}{\bar{PB}_{n,b}^{sell-MG}}$	Maximum sold power / block by MGs (MW)
$\frac{PB_{n,b}^{purchase-MG}}{\bar{PB}_{n,b}^{purchase-MG}}$	Maximum purchased power / block by MGs (MW)
$\frac{PB_{t,b}^{RLA}}{\bar{PB}_{t,b}^{RLA}} / \frac{PB_{t,b}^{CLA}}{\bar{PB}_{t,b}^{CLA}} / \frac{PB_{t,b}^{ILA}}{\bar{PB}_{t,b}^{ILA}}$	Max purchased power / block by RCI agg. (MW)
$\frac{V_j^{DN}}{\bar{V}_j^{DN}} / \frac{V_j^{DN}}{\bar{V}_j^{DN}}$	Upper/Lower limit of voltage of DN bus (kV)
$Z_{j,h}^{DN} / R_{j,h}^{DN}$	Impedance/Resistance of DN line (ohm)

Variables

$I_{t,j,h}^{DN} / I_{t,j,h}^{DN-Lin}$	DN feeder current/linearized current (kA/kA ²)
$PB_{t,b}^{Ret} / P_t^{Ret}$	Total amount of retailer's sold power (MW)
$PB_{t,n,b}^{sell-MG} / P_{t,n,b}^{sell-MG}$	Amount of MG's sold power in each block (MW)
$P_{t,n,b}^{sell-MG}$	Total amount of MG's sold power (MW)
$PB_{t,n,b}^{purchase-MG} / P_{t,n,b}^{purchase-MG}$	Amount of MG's purchased power /block (MW)
$P_{t,n,b}^{purchase-MG}$	Total amount of MG's purchased power (MW)
$PB_{t,b}^{RLA} / P_{t,b}^{RLA}$	Amount of RLA's purchased power /block (MW)
$PB_{t,b}^{CLA} / P_{t,b}^{CLA}$	Amount of CLA's purchased power /block (MW)
$PB_{t,b}^{ILA} / P_{t,b}^{ILA}$	Amount of ILA's purchased power /block (MW)
$P_t^{RLA} / P_t^{CLA} / P_t^{ILA}$	Total amount of RLA's purchased power (MW)
P_t^{CLA} / P_t^{ILA}	Total amount of CLA's purchased power (MW)
$P_t^{ILA} / P_{t,d}^{RLA} / P_{t,d}^{CLA} / P_{t,d}^{ILA}$	Total amount of ILA's purchased power (MW)
$P_{t,d}^{RLA} / P_{t,d}^{CLA} / P_{t,d}^{ILA}$	Amount of each RCI DN demand (MW)
$P_{t,j,h}^{flow}$	The amount of power flow from bus j to h (MW)
$p_{t,j,h}^{loss}$	The amount of active power losses (MW)
$V_{t,j}^{DN} / V_{t,j}^{DN-Lin}$	DN bus voltage/linearized voltage (kA/kV ²)
$\lambda_{j,t}^{local market}$	DN locational marginal price (\$/MWh)

I. INTRODUCTION

A. Motivation

Emerging new energy market players including microgrids (MGs) aggregators, distributed energy resources (DERs) aggregators, and load aggregators (LAs) increase the complexity of wholesale markets. From the independent system operator's (ISO) point of view, it is very difficult to control this large number of market players to meet the energy balance of the system in different energy and ancillary service markets. To overcome this challenge, a transition is occurring from centralized wholesale markets into the local energy markets (LEMs). Since distribution system operators (DSO) operate local electricity networks and act as neutral market facilitators as proposed by European Energy Regulators, they enable local markets [1]. To better manage of supplying demand in the real operation, the DSO operates in coordination with transmission system operator (TSO) [2]. The aim of this paper is to model a local day-ahead energy market (LDEM) in which the DSO operates distribution networks by maximizing social welfare of local market players including MGs, LAs, and retailers.

B. Literature Review and Contribution

Different approaches are proposed in the literature to investigate the effect of DER presence on energy and ancillary service markets. In some studies, the DERs are scheduled by a distribution company (Disco) to model their effects on the system power balance. In fact, different decision making frameworks are proposed for Disco since it can trade energy with directly with these resources besides trading energy and reserves within markets. In [3], a mathematical model is presented for operation of a Disco participating in the day-ahead (DA) and real-time (RT) markets as a price-taker player as well as scheduling distributed generators (DGs) and interruptible loads (ILs) in the network. The risk level of the Disco in decision making to participate in DA wholesale market and optimal scheduling of DERs is managed by a two-stage stochastic approach in [4]. Participating of a Disco as a price maker player in wholesale energy and reserve markets and scheduling of DERs in the network is modeled using a bi-level optimization approach in [5]. Optimal bidding strategy of a Disco in both DA and RT wholesale markets is proposed in [6] while it trades energy with renewable energy sources (RESs) in the network. DERs are integrated as MGs to meet part of distribution network's load locally. In such environment, the cooperation between the Disco and MGs should be modeled for optimal operation of the network. The authors of [7, 8] propose hierarchical decision-making frameworks to model the interaction between Disco and MGs in which the operation problem thereof is modeled as the upper- and lower-level problems, respectively. In some studies, the distribution network is comprised of multi-microgrids (MMGs) which are aggregated by the Disco to trade energy with markets. Managing several MGs by the Disco is modeled in [9] to satisfy the loads of distribution network and MGs through optimal energy trading between MGs as well as the wholesale market. In [10, 11], the operation problem of a Disco is modeled while it participates in the

wholesale RT market while trading energy with demand response (DR) and DER aggregators (DERA) in the network.

In all aforementioned studies the operation problem of distribution network is solved by the Disco simultaneously acting as a retailer to sell energy to consumers. The wholesale DA energy market is the main arena for trading power for the day-ahead. The Disco participates in this market to purchase the required energy to meet the demand of distribution network besides optimal scheduling of DERs and optimal cooperation with MGs and aggregators. In some studies the DERs are integrated as MGs aggregator, DERA, and virtual power plants (VPPs), as economic players, to participate individually in the markets. The main problem of this approach is ignoring the technical constraints of distribution networks by the ISO which leads to the operational problems for this network [2]. Although a TSO-DSO iteration approach is proposed to solve this challenge, it leads to heavy operational process which endangers the deadline for finishing the market clearing process as mentioned in details in [12]. To overcome the operational problems of DERs in the power system, new local markets in the distribution network have emerged.

Modeling LEMs from different perspectives has been investigated in a few studies. For providing the ancillary services in distribution and transmission networks, five coordination schemes are proposed in [13] in which the supply-demand balance of the network is investigated for real-time operation in balancing markets. The uncertainties of RESs are managed under a joint active and reactive local market in [14]. A review on coordination frameworks between central and local markets operated by TSO and DSO, respectively is done in [12]. As described in this review, the most studies focus on coordination between DSO and TSO to meet demand in the real-time operation through ancillary service and balancing markets. In these studies, the local markets are cleared to solve the operational challenges of the ISO in the real operation. Since the most amount of required power of the distribution networks is determined in the DA market, proposing a new local market from the view point of the DSO to clear the DA energy market in the distribution network is required to encourage the mentioned economic players to trade energy in this market. Modeling a local day-ahead energy market (LDEM) managed by a DSO for optimal operation of distribution network in the previous day of real operation is proposed as the main contribution of this paper. The DSO receives bids/offers from the retailer, MGs, and LAs regarding which it maximizes the social welfare of market players considering technical constraints of distribution networks. After clearing the market, the optimal power trading between DSO and market players is determined. Moreover, the effects of technical constraints of the network including power losses, line congestion, and voltage limitations on the distribution local market prices (DLMPs) is investigated.

C. Paper Organization

The rest of this paper is organized as follows. The problem description is presented in Section 2. Section 3 deals with mathematical modeling of the problem. Numerical studies are reported in Section 4 and Section 5 concludes the paper.

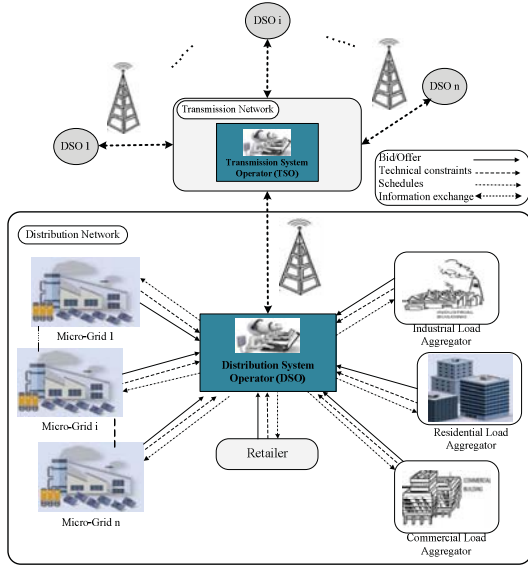

Fig. 1. Proposed structure of local energy market.

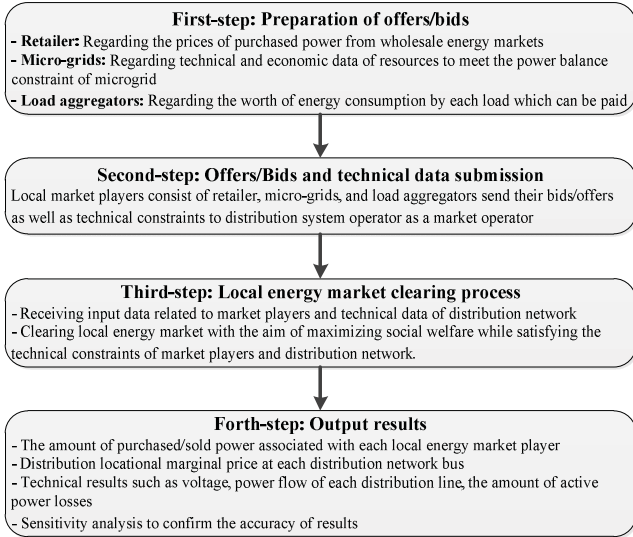

Fig. 2. Procedure of clearing local day-ahead energy market by DSO.

II. PROBLEM DESCRIPTION

In this paper, optimal operation of distribution network is done by a DSO with clearing a LDEM in the presence of a retailer (producer), MGs (prosumers), and LAs (consumer) as shown in Fig. 1. For this purpose, some assumptions are considered as follows:

1) Each market player proposes bids/offers in several blocks in an optimal way to maximize their own profit. Each block contains the maximum amount of trading power with the related prices.

2) Retailer sells the energy merely to the LDEM and there are no other energy contracts between retailer and consumers.

3) The uncertainties of loads, MG resources, and retailer are modeled in their operation problems, their effects are

considered by energy players in the offers/bids and are not considered in the problem of DSO.

Considering these assumptions, the proposed framework is solved in four steps as described in Fig. 2. At first, each local market player provides bids/offers within the technical constraints. The retailer prepares bids/offers regarding its optimal decisions in the wholesale energy markets and its profit. Each MG solves the supply-demand balance of its network with optimal scheduling of resources regarding which is decided upon for optimal participating in LDEM. The LAs prepare bids to purchase energy from the market considering the characteristics of the load. Proposing these bids/offers besides the technical constraints by each player to the DSO is done in the next step. These two steps are considered as the required input data for the proposed LDEM. The local market clearing process by the DSO with the aim of maximizing the social welfare of the market players considering the technical constraints of the distribution network which is considered in the third step is mathematically formulated in section III. The proposed model is solved using the input data prepared in the first and second steps and the DSO informs the market players from the output results of market clearing as the last step.

III. MATHEMATICAL MODELING

In this section, the behavior of the DSO for clearing the local market considering the technical constraints of the network in the presence of MGs, LAs, and a retailer as the local market players is formulated as follows:

$$\text{Maximize } SF = \sum_t \left[\sum_n \sum_b C_{t,n,b}^{Ret} PB_{t,b}^{Ret} - \sum_n \sum_b C_{t,n,b}^{sell-MG} PB_{t,n,b}^{sell-MG} + \sum_b (C_{t,b}^{RLA} PB_{t,b}^{RLA} + C_{t,b}^{CLA} PB_{t,b}^{CLA} + C_{t,b}^{ILA} PB_{t,b}^{ILA}) \right] \quad (1)$$

The social welfare (SF) of local market players is modeled as Eq. (1) consists of four terms. The first term is the cost of purchasing power from retailer. The second and third terms define the financial trading between DSO and MGs, respectively. The revenue from selling energy to the residential LA (RLA), commercial LA (CLA), and industrial LA (ILA) are modeled as the last term.

$$P_t^{Ret} + \sum_{n \in \Lambda_j^{MG}} P_{t,n}^{sell-MG} - \sum_{n \in \Lambda_j^{MG}} P_{t,n}^{purchase-MG} - \sum_{d \in \Lambda_j^{RD}} P_{t,d}^{RD} - \sum_{d \in \Lambda_j^{CD}} P_{t,d}^{CD} - \sum_{d \in \Lambda_j^{ID}} P_{t,d}^{ID} = \sum_{h \in \text{Connection}(j,h)} 0.5(P_{t,j,h}^{Flow} + P_{t,j,h}^{Loss}) \quad \forall t, j=1: \lambda_{t,j}^{Local \text{ market}} \quad (2)$$

$$\sum_{n \in \Lambda_j^{MG}} P_{t,n}^{sell-MG} - \sum_{n \in \Lambda_j^{MG}} P_{t,n}^{purchase-MG} - \sum_{d \in \Lambda_j^{RD}} P_{t,d}^{RD} - \sum_{d \in \Lambda_j^{CD}} P_{t,d}^{CD} - \sum_{d \in \Lambda_j^{ID}} P_{t,d}^{ID} = \sum_{h \in \text{Connection}(j,h)} 0.5(P_{t,j,h}^{Flow} + P_{t,j,h}^{Loss}) \quad \forall t, j \neq 1: \lambda_{t,j}^{Local \text{ market}} \quad (3)$$

Eqs. (2) and (3) are used to model the power balance constraints between the market players including the power flow of the distribution network at bus 1 and the others, respectively. $P_{t,j,h}^{Flow}$ and $P_{t,j,h}^{Loss}$ are described as (15) and (16).

$$0 \leq PB_{t,b}^{Ret} \leq \overline{PB}_{t,b}^{Ret} \quad \forall t, b \quad P_t^{Ret} = \sum_b PB_{t,b}^{Ret} \quad \forall t \quad (4)$$

The retailer purchases energy from the wholesale energy market and can sell it to the consumer and MGs through the local market. Since the retailer presents offers for selling energy in several blocks, Eq. (4) is used to limit the amount of sold energy in each block. Moreover, this equation models the power balance of the retailer in which the total amount of purchased power from the wholesale market is equal to summation of selling energy in all blocks to the local market.

$$0 \leq PB_{t,n,b}^{sell-MG} \leq \overline{PB}_{n,b}^{sell-MG} \quad \forall t, n, b \quad (5)$$

$$0 \leq PB_{t,n,b}^{purchase-MG} \leq \overline{PB}_{n,b}^{purchase-MG} \quad \forall t, n, b \quad (6)$$

$$P_{t,n}^{sell-MG} = \sum_b PB_{t,n,b}^{sell-MG}, \quad P_{t,n}^{purchase-MG} = \sum_b PB_{t,n,b}^{purchase-MG} \quad \forall t, n \quad (7)$$

Eqs. (5)-(6) indicate the limitation of power selling/purchasing of MGs in each block. Eq. (7) describes the equality of total amount of sold/purchased power and summation of it in all blocks.

$$0 \leq PB_{t,b}^{RLA} \leq \overline{PB}_{t,b}^{RLA}, \quad 0 \leq PB_{t,b}^{CLA} \leq \overline{PB}_{t,b}^{CLA} \quad (8)$$

$$0 \leq PB_{t,b}^{ILA} \leq \overline{PB}_{t,b}^{ILA} \quad \forall t, b$$

$$P_t^{RLA} = \sum_b PB_{t,b}^{RLA}, \quad P_t^{CLA} = \sum_b PB_{t,b}^{CLA}, \quad P_t^{ILA} = \sum_b PB_{t,b}^{ILA} \quad \forall t \quad (9)$$

Distribution network loads purchased energy from local market through three aggregators consisting of RLA, CLA, and ILA. Eq. (8) restricts the amount of purchased power by these aggregators in each energy block. In Eq. (9) the total amount of purchased power of aggregators is equal to summation of purchased power in all blocks.

$$\sum_b PB_{t,b}^{RLA} = \sum_{d \in \Lambda_j^{RD}} P_{t,d}^{RD}, \quad \sum_b PB_{t,b}^{CLA} = \sum_{d \in \Lambda_j^{CD}} P_{t,d}^{CD} \quad (10)$$

$$\sum_b PB_{t,b}^{ILA} = \sum_{d \in \Lambda_j^{ID}} P_{t,d}^{ID} \quad \forall t$$

$$0 \leq P_{t,d}^{RD} \leq \overline{P}_{t,d}^{RD}, \quad 0 \leq P_{t,d}^{CD} \leq \overline{P}_{t,d}^{CD}, \quad 0 \leq P_{t,d}^{ID} \leq \overline{P}_{t,d}^{ID} \quad \forall t, d \quad (11)$$

The amount of purchased power by each aggregator indicated after local market clearing must be equal to the amount of distribution network load consumption integrated by the associated aggregators. This behavior is modeled by (10). Each aggregator utilizes the summation of respective loads consumption in the local energy market. However, it is clear that the amount of each load located at distribution network buses in each aggregator's area should be restricted by (11).

$$I_{t,j,h}^{DN} = V_{t,j}^{DN} - V_{t,h}^{DN} / Z_{j,h}^{DN}, \quad -\overline{I}_{j,h}^{DN} \leq I_{t,j,h}^{DN} \leq \overline{I}_{j,h}^{DN} \quad \forall t, j, h \quad (12)$$

$$V_{-j}^{DN} \leq V_{t,j}^{DN} \leq \overline{V}_j^{DN} \quad \forall t, j \quad (13)$$

$$P_{t,j,h}^{Fm} - P_{t,j,h}^{To} = (R_{j,h}^{DN} / (Z_{j,h}^{DN})^2) \left((V_{t,j}^{DN})^2 - (V_{t,h}^{DN})^2 \right) \quad \forall t, j, h \quad (14)$$

$$P_{t,j,h}^{Fm} + P_{t,j,h}^{To} = R_{j,h}^{DN} (I_{t,j,h}^{DN})^2 \quad \forall t, j, h \quad (15)$$

The technical constraints related to distribution network are presented as Eqs. (12)-(15). The amount of feeders current and

their upper and lower limitations are defined by (12). The limitations of bus voltages is modeled as (13). Eqs. (14) and (15) are used to model the amount of active power flows in the network. $P_{t,j,h}^{Fm}$ is the active power flow moves from bus j to bus h and $P_{t,j,h}^{To}$ is the active power flow moves from bus h to bus j . Eq. (16) calculates the amount of power losses in each feeder (if: $I_{i,j,t}^{DN}$ or $I_{j,i,t}^{DN} \geq 0$; otherwise is equal to 0). The non-linear terms $((V_{t,j}^{DN})^2$ and $(I_{t,j,h}^{DN})^2$) are transformed with linear ones regarding the piecewise approach proposed in [15] as follows:

$$V_{t,j}^{DN-Lin} = -V_{-j}^2 + 2V_{-j}V_{t,j}^{DN} + \Delta V_{t,j}^{Lin} \quad \forall t, j \quad (16)$$

$$I_{t,j,h}^{DN-Lin} = \sum_k (2k-1) \left(\overline{I}_{j,h}^{DN} / K \right) \Delta I_{t,j,h,k} \quad \forall t, j, h \quad (17)$$

where $\Delta V_{t,j}^{Lin}$, k , K , and $\Delta I_{t,j,h,k}$ describes the square of $\Delta V_{t,j}$ (summation of all the piecewise voltage magnitude deviations), the current piecewise index, the total number of piecewise segments, and the value of the k th block of the current flow magnitude of feeders. The proposed linear power flow equations (12)-(17) in this paper are valid only for radial distribution networks. The other linearization methods such as convex relaxations are proposed in several studies to obtain global optimum in optimal power flow problem of distribution networks [16]. The resulting model is a linear problem with 213265 single equations and 109585 single variables which is solved using CPLEX12 solver through GAMS.

IV. NUMERICAL RESULTS

The proposed model is applied to IEEE 33-bus system to investigate the effect of bids/offers of market players on DLMPs. In Fig. 3, the network structure and location of the market players is shown. Since purchased power from retailers by the DSO is received by the transmission network, the retailer is connected to bus 1. The maximum amount of distribution network load, the power share of each LAs, and the maximum capacity of the retailer are illustrated in Fig. 4. The aforementioned data, percent of load located at each bus, and technical data of the test system were extracted from [4, 17]. The maximum sold/purchased power of each MG is presented in [8]. The lower and upper bounds of bus voltage amplitudes are defined as 0.9 and 1.1p.u, respectively. It should be noted that, three blocks for offers/bids related to each market player are considered. The amount of energy in each block was set to be one-third the maximum amount. In addition, bids/offers in each block submitted by market players are given in Table I. Offers of retailer are set in each block as 1.05, 1.15, 1.25 percent of DA market prices as calculated in [4].

The DLMP, power balance between market players, and a comprehensive analysis on the impacts of technical constraints on the local market results are depicted in Figs. 5-8. DLMP for two buses (10 and 33) in each hour and for all buses in hours 1 and 22 is shown in Fig. 5. Considering power losses in the distribution network, the DLMP at each bus where the current is injected is lower than the one where it is received. For example, the DLMP of bus 1 is lower than that of bus 2 since current flows from bus 1 to bus 2. Moreover, DLMP is varied in the time period of operation as shown in Fig. 5 regarding the load profile and bids/offers of market players.

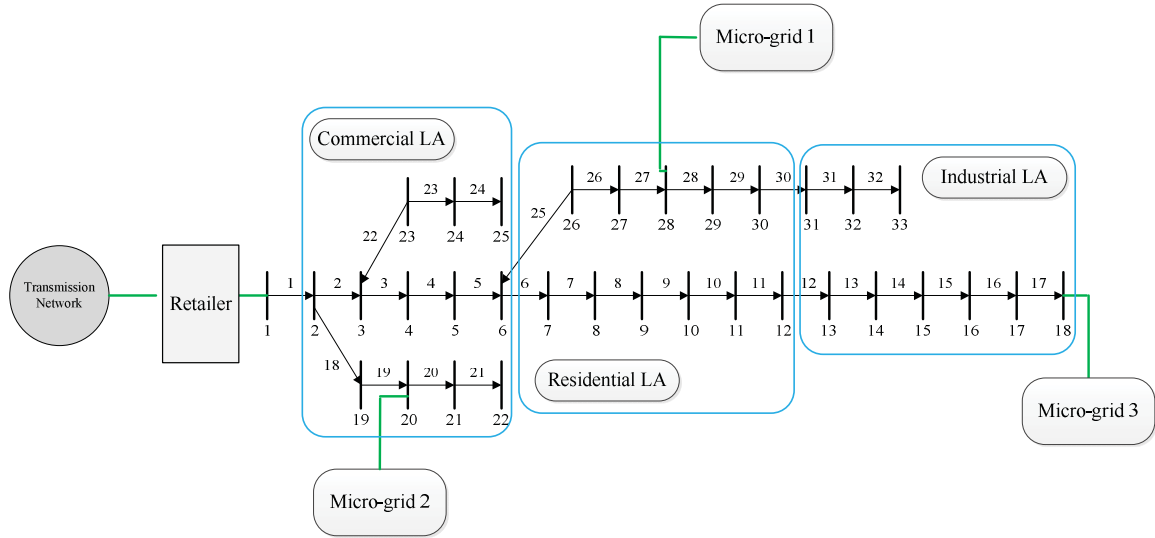

Fig. 3. The structure of IEEE 33-bus network with local market players

The output results of local market including the power sold/purchased by market players and the power losses are given in Fig. 6. It is clear that MGs trade energy with local market considering their bids/offers. The amount of purchased power by RLA, CLA, and ILA depend on their bids and the technical constraints of the network. The total amount of purchased energy by LAs decreases from 852.625MW to 822.106MW considering power losses. This behavior occurred since power losses increase the local energy prices and therefore, the amount of purchased power especially by RLA (in block 2 and 3) and CLA (in block 3) decreases.

In Fig. 7, the sensitivity of bus voltages as well as the amount of purchased power by LAs to the technical constraints of the network consisting of power losses and line congestion is presented. For this purpose, when the power losses is not considered in the model, the market prices is known as distribution market clearing price (DMCP). The problem is solved considering the power losses as the base case. Moreover, for line congestion the amount of power flow at lines 3-23 and 10-11 is restricted from 60MW to 6.5MW and 10MW, respectively. Since the LAs purchase more energy from the DMCP case, the network voltage decreases in this case. On the other hand, regarding the power losses and line congestion constraints, purchased power by LAs decrease which lead to increasing the buses voltage of the network.

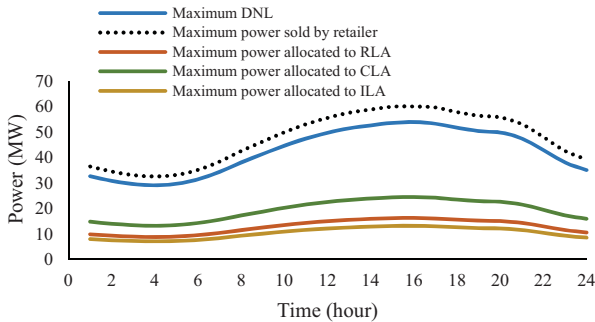

Fig. 4. The maximum power consumption/generation in 24 hours

TABLE I. OFFER/BID PRICE DATA

Market player	Number of blocks (\$/MWh)		
	Block1	Block2	Block3
RLA	24.15	21.84	19.11
CLA	25.30	22.88	20.02
ILA	26.45	23.92	22.93
MG1 (t1-t12)-(t21-t24)	10.215	10.75	11.35
MG1 (t13-t20)	23.24	22.95	22.75
MG2 (t1-t14)	24.15	23.68	23.00
MG2 (t15-t21)	11.15	12.30	12.962
MG2 (t22-t24)	22.95	22.75	22.50
MG3 (t1-t10)-(t19-t24)	10.145	10.82	11.52
MG3 (t11-t18)	23.35	23.18	23.05

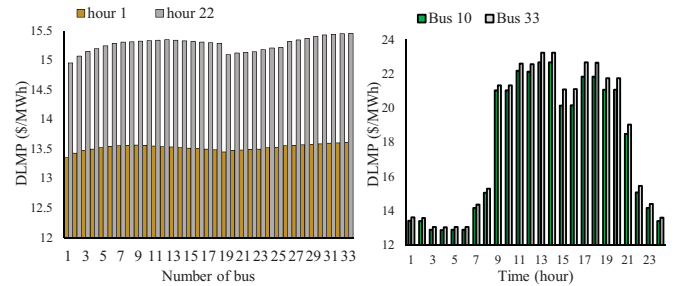

Fig. 5. The amount of DLMP in base case

Considering the technical constraints of the network such as power losses, line congestion, and voltage limitations, the market prices change from DMCP to DLMP as shown in Fig. 8 at hour 15. The lower bound of bus voltage is limited to 0.96p.u for voltage limitation constraint. These constraints also change the social welfare of the system. As shown in this figure, the social welfare of the system decreases in the presence of technical constraints so that with power losses and line congestion, the social welfare is minimum.

On the other hand, regarding these technical constraints, the local market prices increase so that for the buses in the end of feeder they reach the maximum. As a result, the function of the DSO with the purpose of decreasing the impacts of line congestion, as well as power losses, can considerably change the social welfare toward the maximum amount.

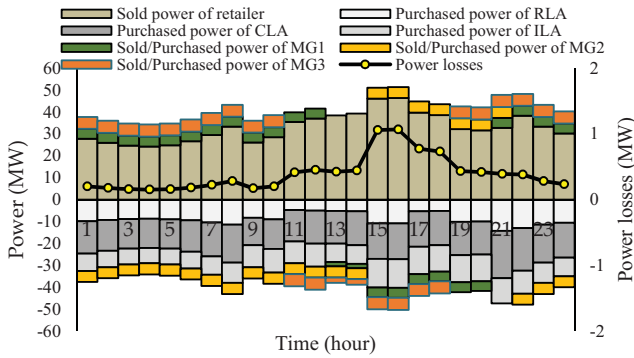

Fig. 6. Trading power between local market players in base case

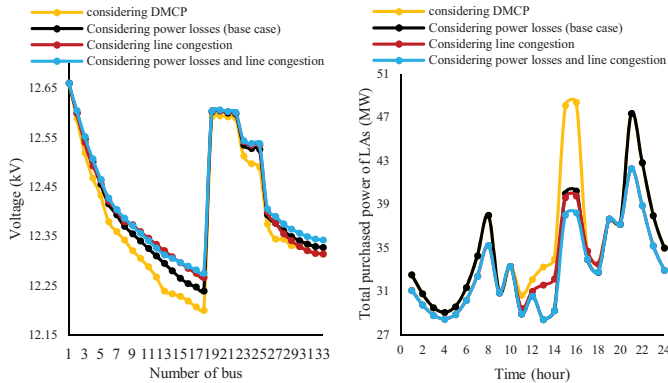

Fig. 7. Sensitivity of DN voltage and LA's purchased power to technical characteristics of DN

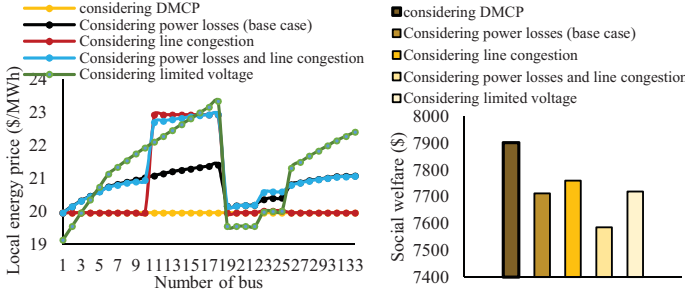

Fig. 8. Sensitivity of DLMP and social welfare at hour 15 to the technical limitations in the DN

V. CONCLUSION

In this paper, a LDEM is cleared by the DSO for optimal operation of the distribution network. MGs, LAs, and a retailer submit their offers/bids to the DSO, while the DSO maximizes social welfare of the market players. The proposed model is applied on the IEEE 33-bus test system. The results show that the power losses have an important impact on purchasing power by the LAs such that by increasing power losses in some hours, their purchased power decreases. Moreover, the technical constraints of distribution networks including power losses, line congestion, and voltage limitations have different impacts on local market prices in distribution network's buses. In several buses the voltage limitation increases the market prices and for some others the combination of power losses and line congestion increases the DLMP. On the other hand, in the presence of line congestion and power losses the social welfare

of the market players decreases. Therefore, the market players are encouraged to cooperate with the DSO under regulatory conditions to reinforce the technical indices of the network to increase the social welfare of the system. The proposed model in this paper can be extended to model a joint energy and reserve local energy market in the distribution network as a future work.

ACKNOWLEDGEMENTS

J.P.S. Catalão acknowledges the support by FEDER funds through COMPETE 2020 and by Portuguese funds through FCT, under SAICT-PAC/0004/2015 (POCI-01-0145-FEDER-016434) and 02/SAICT/2017 (POCI-01-0145-FEDER-029803).

REFERENCES

- [1] https://ec.europa.eu/energy/sites/ener/files/documents/wp_acer_02_17.pdf
- [2] H. Gerard, E. Rivero, and D. Six, "Basic schemes for TSO-DSO coordination and ancillary services provision," *SMARTNET Deliv. D*, vol. 1, 2016.
- [3] A. Safdarian, M. Fotuhi-Firuzabad, and M. Lehtonen, "A Stochastic Framework for Short-Term Operation of a Distribution Company," *Power Systems, IEEE Transactions on*, vol. 28, pp. 4712-4721, 2013.
- [4] P. Sheikahmadi, S. Bahramara, J. Moshagh, and M. Yazdani Damavandi, "A risk-based approach for modeling the strategic behavior of a distribution company in wholesale energy market," *Applied Energy*, vol. 214, pp. 24-38, 2018.
- [5] S. Bahramara, M. Yazdani-Damavandi, J. Contreras, M. Shafie-Khah, and J. P. Catalão, "Modeling the strategic behavior of a distribution company in wholesale energy and reserve markets," *IEEE Transactions on Smart Grid*, vol. 9, pp. 3857-3870, 2018.
- [6] C. Zhang, Q. Wang, J. Wang, M. Korpás, P. Pinson, J. Østergaard, et al., "Trading strategies for distribution company with stochastic distributed energy resources," *Applied energy*, vol. 177, pp. 625-635, 2016.
- [7] S. Bahramara, M. P. Moghaddam, and M. Haghifam, "A bi-level optimization model for operation of distribution networks with micro-grids," *International Journal of Electrical Power & Energy Systems*, vol. 82, pp. 169-178, 2016.
- [8] S. Bahramara, M. P. Moghaddam, and M. R. Haghifam, "Modelling hierarchical decision making framework for operation of active distribution grids," *IET Generation, Transmission & Distribution*, vol. 9, pp. 2555-2564, 2015.
- [9] Y. Lin, P. Dong, X. Sun, and M. Liu, "Two-level game algorithm for multi-microgrid in electricity market," *IET Renewable Power Generation*, vol. 11, pp. 1733-1740, 2017.
- [10] C. Zhang, Q. Wang, J. Wang, J. M. Morales, P. Pinson, and J. Ostergaard, "Real-time procurement strategies of a proactive distribution company with aggregator-based demand response," *IEEE Transactions on Smart Grid*, 2016.
- [11] Q. Wang, C. Zhang, J. Wang, P. Pinson, and J. Ostergaard, "Real-time trading strategies of proactive DISCO with heterogeneous DG owners," *IEEE Transactions on Smart Grid*, 2016.
- [12] Y. Tohidi, M. Farrokhshesht, and M. Gibescu, "A Review on Coordination Schemes Between Local and Central Electricity Markets," in *2018 15th International Conference on the European Energy Market (EEM)*, 2018, pp. 1-5.
- [13] H. Gerard, E. I. R. Puente, and D. Six, "Coordination between transmission and distribution system operators in the electricity sector: A conceptual framework," *Utilities Policy*, vol. 50, pp. 40-48, 2018.
- [14] R. H. Zubo, G. Mokryani, and R. Abd-Alhameed, "Optimal operation of distribution networks with high penetration of wind and solar power within a joint active and reactive distribution market environment," *Applied Energy*, vol. 220, pp. 713-722, 2018.
- [15] M. J. Rider, J. M. López-Lezama, J. Contreras, and A. Padilha-Feltrin, "Bilevel approach for optimal location and contract pricing of distributed generation in radial distribution systems using mixed-integer linear programming," *IET Generation, Transmission & Distribution*, vol. 7, pp. 724-734, 2013.
- [16] L. Gan, N. Li, U. Topcu, and S. H. Low, "Exact convex relaxation of optimal power flow in radial networks," *IEEE Transactions on Automatic Control*, vol. 60, pp. 72-87, 2015.
- [17] M. Doostizadeh and H. Ghasemi, "Day-ahead scheduling of an active distribution network considering energy and reserve markets," *International Transactions on Electrical Energy Systems*, vol. 23, pp. 930-945, 2013.