



V A A S A N Y L I O P I S T O

GUANGYU XIONG

Supply Chain Inventory Control for
the Iron and Steel Industry

ACTA WASAENSIA

No. 163

Industrial Management 12

UNIVERSITAS WASAENSIS 2006

Reviewers Professor Christer Carlsson
 Åbo Akademi University
 Institute for Advanced Management
 Lemminkäisenkatu 14 B
 FI-20520 Turku
 Finland

 Professor Angappa Gunasekaran
 University of Massachusetts
 Charlton College of Business
 Department of Management
 285 Old Westport Road
 North Dartmouth
 MA 02747-2300
 USA

ACKNOWLEDGEMENTS

I would first and foremost like to thank my main advisor, Professor Petri Helo, for his support and guidance throughout the ASDN (Agile Supply–Demand Networks) project. Without his help, the realisation of my thesis would have still been in doubt. I would also like to express my gratitude to Professor Angappa Gunasekaran (University of Massachusetts, USA) and Professor Christer Carlsson (Abo Akademi University, Finland) for their review and helpful comments on this thesis. John Shepherd helped with the English language revision, and I express my thanks to him for his kind help.

The research work has been mainly based on the case study of a Chinese iron & steel company (SLC). During my research, I received great help from the company and I would therefore like to express my appreciation to all persons at SLC, China who helped me in obtaining valuable information, gave interviews, and answered my questions. Especially I would like to thank Lan Xinzhe and Zhang XiaoMin, who were key persons in rendering assistance. They were the persons who took responsibility and gave invaluable help during the research.

I also want to express my thanks to Professor Hannu Koivisto, Professor Timo R. Nyberg and Professor Pertti Mäkilä for their valuable support and guidance during my research. The dissertation research was supported by the ASDN project, funded by the Finnish Ministry of Transport and Communication and the ABB Corporate Research Centre, and partly supported by the Paper Manufacturing Post-Graduate School (PMGS), Tampere University of Technology.

Finally, I would like to thank my family, especially my lovely son, Duoduo, and also all my friends who gave their support and understanding in helping me to complete this work.

May 2006.

Guangyu Xiong

CONTENTS

ACKNOWLEDGEMENTS	2
LIST OF TABLES	7
LIST OF FIGURES	7
NOTATIONS	8
ABBREVIATIONS	10
ABSTRACT	12
1 INTRODUCTION	13
1.1 Dissertation Objective	13
1.2 Problem Statement	13
1.2.1 Brief Description of Supply Chain Inventory in the Iron & Steel Industry	13
1.2.2 Problem of Traditional Inventory Model in Company “SLC”	17
1.3 The Research Questions and Research Approach	22
1.4 Contribution of the Research	26
2 LITERATURE REVIEW AND DEVELOPMENT OF THE TRADITIONAL INVENTORY MODEL	28
2.1 Overview	28
2.2 Inventory Control Model and its Development	28
2.3 Fuzzy set theory Applications in Supply Chain Inventory Management	33
3 ANALYSIS AND EVALUATION OF TRADITIONAL INVENTORY MODEL	41
3.1 Overview	41
3.2 Supply Chain Inventory Management and Inventory Control Policy	41
3.2.1 Common Problems in Supply Chain Inventory Control	41
3.2.2 A Generalized Inventory Model	49
3.2.3 EOQ Type Models	52
3.2.4 Shortening Lead-time by Inventory model	69
3.3 EOQ Models and Periodic Policy in the Development of Modern Industry	72
3.3.1 EOQ Models Falling into Disfavour in Modern Industry	72
3.3.2 Main Reasons for the EOQ Model Limitations in Modern Industry	74
4 COMBINING FUZZY LOGIC CONTROL AND (s, S) POLICY IN INVENTORY MANAGEMENT	75
4.1 Overview	75
4.2 Foundations of Fuzzy Set Theory	75

4.2.1	Fuzzy Sets.....	77
4.2.2	Membership Functions	78
4.2.3	Fuzzy Logical Operations.....	80
4.2.4	Fuzzy Rules	80
4.2.5	Defuzzification	82
4.2.6	Fuzzy Inference Systems	82
4.3	Proposed FICM	83
4.4	Application of FICM to Counteract Demand Fluctuations	91
4.4.1	Demand Fluctuations and Causes.....	93
4.4.2	Counteracting and Coping with Demand Fluctuations in Inventory Management.....	97
4.4.3	General Counteraction to Demand Fluctuations in Traditional Industry	99
4.4.4	Application of Proposed FICM to Counteract Demand Fluctuations	101
5	CASE STUDY.....	110
5.1	Overview	110
5.2	Preliminary Outline	111
5.2.1	Technological Challenges Facing Raw Materials Inventory in SLC.....	112
5.2.2	Numerical Illustrations	115
5.3	Model Formulation and Statement	124
5.3.1	The Extension (s, S) Policy for Raw Materials Inventory in SLC.....	127
5.3.2	The FICM for Raw Material Inventory	129
6	NUMERICAL EXPERIMENTS AND DISCUSSION.....	132
6.1	Overview	132
6.2	Experiment Details	132
6.2.1	Assumptions	133
6.2.2	Generating the Demand Distributions	134
6.2.3	Decisions on Ordering Raw Materials	137
6.2.4	Testing with Simulation	138
6.2.5	Performance Measures	140
6.3	Results from the Simulation	141
6.4	More Comparison.....	155
7	SUMMARY AND SUGGESTIONS FOR FUTURE RESEARCH	160
7.1	Overview	160
7.2	Summary.....	160
7.3	Suggestions for Future Research	166
	REFERENCES.....	169
	APPENDICES.....	178

LIST OF TABLES

Table 1.	Estimated global requirement for steel-making materials	15
Table 2.	Fuzzy research findings in inventory management (Guiffrida and Nagi, 1997)	35
Table 3.	General classifications with respect to characteristics of demand	44
Table 4.	Lead-time segment (Murgiano, 1994)	69
Table 5.	Comparison between EOQ and PBC	73
Table 6.	Relations ¹ between demands, inventory level and order quantity	88
Table 7.	Relations ² between demands, inventory level and order quantity	88
Table 8.	Development of the bullwhip effect (Disney and Towill, 2003).....	96
Table 9.	Remedies for the bullwhip effect.....	97
Table 10.	Value of some parameters	125
Table 11.	Annual cost, order times, service level and comparison – uniform PDF	143
Table 12.	Annual cost, order times, service level and comparison – normal PDF.....	143
Table 13.	Annual cost, order times, service level and comparison – sine distribution	143
Table 14.	Annual cost, order times, service level and comparison– exponential PDF	144
Table 15.	Average inventory cost and its improvement– uniform PDF	144
Table 16.	Average inventory and its improvement –normal PDF ($\sigma = 12, \mu = 26$).....	144
Table 17.	Average inventory and its improvement –sine distribution	145
Table 18.	Average inventory and its improvement –exponential PDF ($\gamma = 15$).....	145
Table 19.	Performance measures of one stage FICM.....	145
Table 20.	Performance measures of two-stage FICM	146
Table 21.	Demand-magnification effect measures of two-stage inventory model....	146

LIST OF FIGURES

Figure 1.	Current inventory control model in SLC	20
Figure 2.	Research framework	25
Figure 3.	Variation of the four cost components	48
Figure 4.	Lot size system ($p = \infty$)	53
Figure 5.	Cost curve in lot size system	54
Figure 6.	Probability density function (PDF) of demand for the continuous case....	57
Figure 7.	A continuous model with instantaneous demand	60
Figure 8.	Curves $C(S)$ and $C_T(S)$ in discrete case	63
Figure 9.	Extension (s, S) policy	68
Figure 10.	U and lot size with lead-time (Suri).....	71
Figure 11.	Fuzzy set and crisp set	77
Figure 12.	Features of the triangular membership function.....	79
Figure 13.	Fuzzy membership functions for demand, inventory and order.....	89
Figure 14.	Supply chain maturity model: the path toward on demand.....	91
Figure 15.	The bullwhip effect (Accenture).....	93

Figure 16.	Higher variability in orders due to the Bullwhip Effect (Lee, 1997a).....	94
Figure 17.	Customer demand forecast patterns.....	99
Figure 18.	Supply network structure model in the iron and steel industry	102
Figure 19.	FICM in SDN	105
Figure 20.	Multiple FICM in SDN	107
Figure 21.	Implementing counteracting strategies and FICM (Author)	109
Figure 22.	Flow chart of case study	111
Figure 23.	Blast Furnace (BF)	112
Figure 24.	Quantity discount structure for the iron ore.....	119
Figure 25.	Raw materials supply chain inventory management in SLC.....	126
Figure 26.	Overview of Fuzzy inventory modelling approach	130
Figure 27.	Two–stage FICM in the case study.	139
Figure 28.	Comparison of fuzzy with classical model– uniform demand distribution.....	148
Figure 29.	Comparison of fuzzy with classical model– normal demand distribution.....	149
Figure 30.	Comparison of fuzzy with classical model– sine wave demand	151
Figure 31.	Comparison of fuzzy with classical model– exponential demand distribution.....	152
Figure 32.	Response of one–stage model to fluctuating demand	153
Figure 33.	Response of two–stage model to fluctuating demand	154
Figure 34.	Response of order of 1st stage of two–stage model to fluctuating demand	154
Figure 35.	Response of order of 2nd stage of two–stage model to fluctuating demand	155
Figure 36.	Comparison of average inventory level.....	156
Figure 37.	Comparison of annual cost	157
Figure 38.	Comparison of service level	157

NOTATIONS

n	Total length of the planning horizon.
i	Number of period.
j	Number of material items.
k	each item of materials, $k \in [1, j]$.
D_{avg_k}	Average weekly demand per year (ton/week), $k \in [1, j]$.
L	Inventory lead–time (weeks)
K_k	Ordering cost for placing an order (Yuan/order), $k \in [1, j]$.
h_k	Holding cost per unit inventory per unit time per year (Yuan /ton).

- g_k Shortage or emergency–order cost (Yuan /ton/ shortage).
 c_k Purchasing cost (Yuan/ton).
 T Review period (week).
 OT Number of times of ordering.
 OP Ordering percentage (OT/n).
 Q_{sk} Emergency–order quantity kth items.
 Q_k Purchasing quantity of kth items per year (ton/year).
 ST_k Emergency–order times per year.
 SP_k Emergency–order percentage (ST_k/n).
 SS_k Safety stock (ton).
 Mad_k Max. weekly demand of kth items per year (ton).
 Mid_k Min. weekly demand of kth items per year (ton).
 s_k Re–order level (ton).
 S_k Ending inventory (Order–up–to level) of kth items at every period (ton)
 $Finv_k$ Forecast inventory at lead–time from now.
 Q_k Order quantity of kth items at period i (ton).
 D_j Demand of kth items at period i .
 CT_k Min. inventory cost of each item.
 CTU Total annual min. inventory cost (Yuan).
 C_h Total annual holding cost (Yuan).
 C_o Total annual ordering cost (Yuan).
 C_s Total annual shortage or emergency–order cost (Yuan).
 C_p Total annual purchasing cost (Yuan).
 PDF Probability Density Function.
 f Mathematical function for different purpose, e.g. $Q_i=f(S_i, D_i)$.
 Std_D Standard deviation of demand distribution.
 Std_Q Standard deviation of order quantity.
 Std_S Damping effect of inventory to demand fluctuations. $Damp = \frac{Std_S - Std_D}{Std_D}$
 ω Demand–magnification effect $\omega = \frac{c_{out}}{c_{in}} = \frac{c_{out} |_{Order}}{c_{in} |_{Demand}}$

- ω_1 1st stage demand–magnification effect $\omega_1 = \frac{C_{out_1}}{C_{in_1}} = \frac{C_{out_1|order1}}{C_{in_1|Demand1}}$
- ω_2 2nd stage demand–magnification effect $\omega_2 = \frac{C_{out_2}}{C_{in_2}} = \frac{C_{out_2|order2}}{C_{in_2|Demand2}} = \frac{C_{out_2|order2}}{C_{in_2|order1}}$
- ω_t The final stage (next to supplier, for example second stage) order to end customer (first) demand–magnification effect $\omega_t = \frac{C_{out_2|order2}}{C_{in_2|Demand1}}$

ABBREVIATIONS

BF	Blast Furnace
BOF	Basic Oxygen Furnace
DC	Distribution Center
EBQ	Economic Batch Quantity
EDI	Electronic Data Interchange
EOQ	Economic Order Quantity
FICM	Fuzzy Inventory Control Model
FLC	Fuzzy Logic Control
GA	Genetic Algorithms
GT	Group Technology
IISI	International Iron and Steel Institute
JIT	Just–In–Time
LM	Lean Manufacturing
MF	Membership Functions
MPC	Manufacturing Planning and Control
MPS	Master Production Schedule
MRP	Material Requirement Planning
OPT	Optimised Production Technology
PBC	Period Batch Control
PDF	Probability Density Function
QRM	Quick Response Manufacturing
SDN	Supply Demand Networks

SIMM	Standard Inventory Management Models
SKU	Stock Kept Unit
SLC	Pseudonym of Chinese iron and steel company in the case study (real name kept confidential)
SS	Safety Stock
TOC	Theory Of Constraints
TQM	Total Quality Management
WIP	Work In Proces

ABSTRACT

Guangyu Xiong (2006). Supply Chain Inventory Control for the Iron and Steel Industry. *Acta Wasaensia* No. 163, 197 p.

This dissertation is written in relation to the iron and steel industry and mainly conducted based on a case study of an iron and steel corporation, one of the typical medium iron and steel-makers in China (2,000,000 tons per year), which, for confidentiality purposes, will be called "SLC". The research focuses on inventory control models. It first investigates the standard inventory management models (SIMM), and tries to apply modern fuzzy logic to the traditional inventory approach for the traditional iron and steel industry. Then a cost-effective supply chain inventory model is presented for the materials inventory of production with the purpose of making improvements: this uses fuzzy logic controller combined with the traditional inventory model. Finally, a simulation is used to test and analyse the model. The overall objectives of the research are to propose a fuzzy inventory control model (FICM) and investigate how the proposed model improves efficiency and reduces the total inventory costs in a real company by the inventory control model; then how the proposed FICM can improve the ability to counteract demand fluctuations when the model is extended to supply-demand networks if changing markets are taken into account in the demand. The proposed inventory model is used to develop propositions from the findings that can be presented by SIMM and modern fuzzy set theory. A qualitative case study is undertaken using the proposed inventory model with the benefits from the traditional inventory model and modern fuzzy logic issues.

Company "SLC" has provided related information on the inventory and production process. An effective supply chain inventory model is established, where the (s, S) policy and fuzzy logic combined with (s, S) policy are both performed. The effectiveness of the inventory control model is studied by simulation.

The modelling efforts with the case study of a real company significantly increase its relevance and therefore its perceived value to real cases. As a conclusion the research provides companies with a useful inventory model of supply chain management, especially applicable to the iron and steel industry, which will lead to higher efficiency in iron and steel making. Moreover, the research provides new insights into applying existing knowledge to a real company, which seems to be a fairly untouched area of application in the iron and steel industry. With the selected research method, the conclusions are valid in the case study setting and related generalizations to a wider context should be further studied.

Guangyu Xiong, Department of Industrial Management, University of Vaasa, P.O.Box 700, FI-65101 Vaasa, Finland.

Key words: Inventory control, EOQ, (s, S) policy, fuzzy control, iron and steel industry

1 INTRODUCTION

1.1 Dissertation Objective

This dissertation researches supply chain inventory control for application in the iron and steel industry. It focuses on alternative approaches to the traditional inventory model and simulates supply chain inventory control, and analyses the effect of control strategies based on the simulation. Fuzzy logic is combined with the traditional inventory model to create an improved inventory control model. The dissertation starts with an investigation of the traditional inventory control model and problems in the iron and steel industry, and continues with a proposed fuzzy inventory control model (FICM) based on a fuzzy logic controller combined with the (s, S) policy for supply chain inventory control of raw materials in Company “SLC”, which is a typical medium sized iron and steel-maker in China, producing 2,000,000 tons per year. Subject to the demand cases (stochastic demand case and demand with imprecise fluctuation case caused by fluctuating markets) for stable raw materials supply, the proposed fuzzy model applies the fuzzy logic controller to make inventory costs lower and to improve the ability to counteract the demand-magnification effect. In the case study the simulation takes the sample and collection of real historical data from Company SLC, and applies them to the simulation and analysis. Finally, the issues specific to the FICM of Company “SLC” are presented. Based on investigation of standard inventory management models (SIMM) and study of modern fuzzy set theory, the research is combining the (s, S) policy with a fuzzy logic controller, and proposes FICM benefiting from traditional and modern issues for the real case company. The research provides an approach benefiting from traditional and modern issues for the industry.

1.2 Problem Statement

1.2.1 Brief Description of Supply Chain Inventory in the Iron & Steel Industry

Before describing the research itself, this section provides additional background on the problem, including a brief description of supply chain inventory control and its related

techniques that are applied in the traditional iron and steel industry, which is the background of this research.

Over the last decade, the world has changed from a marketplace with several large, almost independent markets, to a highly integrated global market demanding a wide variety of products that comply with high quality, reliability, and environmental standards. Moreover, today's changing industry dynamics have influenced the design, operation, and objectives of supply chain systems by placing emphasis on (1) improved customer service, (2) reduced cycle time, (3) improved products and service quality, (4) reduced costs, (5) integrated information technology and process flow, (6) planned and managed movement, and (7) flexible product customisation to meet customer needs. Effective management of supply chain systems is achieved by identifying customer service requirements, determining inventory placement and levels, and creating effective policies and procedures for the coordination of supply chain activities.

This research is particularly about supply chain inventory management in the iron and steel industry, which has a reputation for being conservative, slow and dirty. The demand in this industry fluctuates a lot because of the changing markets. According to the projections by IISI (The International Iron and Steel Institute, Brussels, 03 October 2005), the prospects are still for continued real growth in the demand for steel worldwide. Apparently, steel demand is forecast to grow to between 1,040 and 1,053 million tonnes in 2006 from a total of 972 million tonnes in 2004. This is a growth of 4–5% over the two year period. The strongest growth continues to come from China, which should see a 10% increase in steel demand in 2005 and a further 7–10% growth in 2006 (<http://www.worldsteel.org/news/107>). Looking further ahead to 2007 (Table 1), if the IISI's forecast of increased steel demand is to be met, then crude steel production would need to rise to 1,130 million tones (http://www.issb.co.uk/pdf/200402_china.pdf). Therefore, as one of the important world industries, the steel industry should have the same profit and market position. But the iron and steel industry is currently under considerable pressure: profits have not been at the high levels which would correspond with the high consumption of the past several years. Moreover,

environmental pressures are steadily increasing due to increasing production and consumption. The reasons for this trend are:

1. Iron and steel making is expensive, since it requires massive amounts of specific types of raw material feeding (supplying) and specific chemical processes.
2. The raw materials must be prepared within tight specifications for the inventory to work efficiently, since iron and steel making is an exact chemical process.
3. Iron and steel making is relatively inflexible from the blast furnace (BF) or basic oxygen furnace (BOF), since it requires specific types of raw material feeds to enable efficient operation.
4. The iron and steel-making operation continues to be a major source of environmental emissions, since the main raw material preparation (coke ovens, iron ore, etc.) cause pollution.

Table 1. Estimated global requirement for steel-making materials

	<i>Million tonnes</i>				
	2001	2002	2003	2004	2007
Steel Demand *	780	831	884	936	1,041
Crude Steel Production	850	902	970	1,016	1,130
Materials					
Iron Ore	1,050	1,120	1,200	1,260	1,400
Coke	300	315	340	355	400
Scrap	375	400	425		500

* IISI forecasts

NB. estimated materials consumed based on current furnace mix.

Iron and Steel Statistics Bureau

There are a lot of opportunities for iron and steel-makers to make supply chain improvements and although they have made progress in this area, the industry still lags behind others. There have not been a lot of improvements regarding inventory turns compared with industries such as electronics and high-tech in the past years. In the past, some companies, including Company "SLC", have only concentrated on alternatives to Blast Furnace (BF) and Basic Oxygen Furnace (BOF) technology that meets the

challenge of increasing environmental and cost pressures, but they have not considered the fluctuating demand of iron and steel markets and improved supply chain management. For example, some steel companies would rather provide an alternative production route that offers competitive solutions to meet the metallic requirement of the iron and steel industry than provide an effective supply chain management that can adjust production according to iron and steel markets. Today, technology is changing fast and allowing greater matching of the supply chain management. Most iron and steel-makers have recognized that they need to improve their supply chain management as well as the technology of production, and they are starting to improve their supply chain management, raising performance to new heights.

Therefore the modern iron and steel-maker needs a very finely tuned supply chain to maintain the feeding of raw materials into the production process with minimum chemical and physical variations and capital costs. Iron and steel-makers should take a strategic decision to concentrate on innovation and efficiency improvement for their supply chain and cost reduction. Especially, considering the changing markets in the iron and steel industry, effective management of supply chain is achieved by identifying fluctuating demand based on a customer service requirements, determining inventory placement and levels based on improved inventory control model, and creating effective policies and procedures for the coordination of supply chain activities and the fluctuating demand of the iron and steel markets.

In summary, the ideal supply chain to an iron and steel company should include the following attributes:

1. High efficiency with respect to materials using supply chain management.
2. Reduced capital costs for inventory and time delay.
3. Flexibility for the fluctuating demand of iron and steel markets.
4. Inventory management flexibility, alarm report while the emergency orders happen so that risk of production can be reduced.

Points 1 and 2 above need the improved materials inventory model to drive the efficiency of the value and supply chains – to reduce costs and to improve the use of

assets along the chain, and make changes that can be significant and offer the potential of increasing returns on assets. Points 3 and 4 need the improved inventory model to take the fluctuating demand of iron and steel markets into account in the production of iron and steel.

1.2.2 Problem of Traditional Inventory Model in Company “SLC”

In a traditional supply chain inventory, the raw materials are purchased and stocked as inventories to be used later in the production processes. In a situation where market demand is fluctuating and unpredictable, sometimes the inventory is built up for the following reasons:

1. To avoid a shortage of raw materials.
2. To take advantage of economies of scale.
3. To maintain a smooth workflow in a multistage production facility.
4. To take advantage of fluctuating market prices.

But these items kept in the warehouse or idle in the store are parts of the accumulating costs and tie up funds that could be otherwise used or invested to earn more profits. For some industries like the food industry, some items are perishable or have a limited shelf life, which can add up to an unexpected loss of profit margin. On the other hand, if the manufacturing line has not enough inventory level to support the production, shortages or emergency orders will be inevitable and disrupt the production processes. Therefore, it is the routine job of a production manager to trade off between the inventory level and lower production cost, which is based on different inventory models (Taha, Operations Research, an introduction, 6th Edition, Chen et al 2001, Cohen et al 1980, Esogbue et al 1997, Fleischmann 1998, Johansen et al 2000, Karmarkar 1993, Rosling 2002).

SIMM are based on the minimization of expected costs, both direct and indirect, and the traditional methods of inventory control use Economic Order Quantity (EOQ) models. The basic EOQ model (Harris, 1913) was based on the assumption that demand is constant, no shortage is considered and the lead-time is zero or constant. These

assumptions do not apply in real life applications. The EOQ model does not take into consideration the demand pattern of the end product before determining the inventory levels and materials. Such unrealistic assumptions make basic EOQ not very attractive in current industrial settings. Besides the basic model, there are many extensions to the EOQ models, which relax some assumptions when the EOQ is applied in industry. For example,

1. Lead-time: allowing a lead-time between placing an order and receiving it introduces the problem of when to order (typically, at some stock level called the re-order point).
2. Shortages or emergency-orders.
3. Buffer (safety) stock: some stock is kept back to be used only when necessary to prevent shortages (emergency-orders).
4. Probabilistic demand: instead of a constant depletion (demand) for stock, probability distributions are allowed. These have two similar classifications: the stationary case, in which the demand probability density function remains unchanged over time; and the non-stationary case, where the demand probability density function varies with time (Taha, *Operations Research, an Introduction*, Macmillan Publishing Company, 5th Edition. p. 483).

The above relaxed assumptions exist in the iron and steel industry. A lead-time exists between the raw materials supplier and receiving the raw materials in the iron and steel industry for feeding the production. Shortages or emergency-orders should be considered when the changing markets are taken into account. Buffer (safety) stock is necessary for the iron and steel company. Probabilistic demand can be used when the steel supply chain is shifting to an incomplete push system.

In the iron and steel making supply chain, iron ore, coke, limestone and coal powder are the chief raw materials for the BF process, and the supply and storage of these raw materials is regarded as an important item. In China, even though rapid economic growth and an improving standard of living are spurring higher and higher levels of high quality steel consumption, there are many iron and steel makers still using the

traditional management model of feeding raw materials to the production, which does not satisfy the attributes proposed in the previous section. Also environmental pressures, capital costs and changing market forces are making steel producers look for new ways to help them meet modern demands. Some Chinese iron and steel-makers have begun developing advanced raw materials inventories alongside expansion of their production. They aim at meeting the demand for a stable supply and changing markets to make raw material inventory costs more competitive with appropriate supply chain inventory control. SLC is one of them.

SLC was founded in 1969. Originally, it started as a local and small iron maker, now it has become the largest steel complex in Western China. The company now aims at an annual output of 3,000,000 tons of steel and steel products. SLC has developed fast in recent years. The annual output has been raised to 2,000,000 tons of steel in 2004 from 300,000 tons of steel per year previously.

By 2003, SLC had accumulated total assets of 1.73 billion Chinese Yuan, an increase of 94 percent. In 2003 the growth of previous years continued and the estimate of total sales income exceeded 1 billion Chinese Yuan, an increase of 149 per cent, and total net profits exceeded 0.12 billion Chinese Yuan, an increase of 303 per compared with the previous year. It ranks highly with major steel producers around Western China.

However, facing economic globalisation and a changing market in the international iron and steel industry, the company is currently under considerable pressure. Prices have been at low levels for many years and environmental pressures are steadily increasing. As a result, to regain competitive advantage, SLC has mapped out a development blueprint in a bid to build itself into a powerful and competitive steel enterprise. One of the points is that SLC plans to further improve supply chain management, and will further lower its inventory costs. In reducing the per ton steel cost in improving the supply chain management, the raw materials inventory is an important part of the supply chain, and in fact, the company has realized that there are some costs that are too high in its supply chain inventory.

In the past, SLC was using the old inventory system (Figure 1) and is still employing it for managing inventory and ordering raw materials (feeding) to the supply chain. The detailed order policy is presented in Chapter 5.

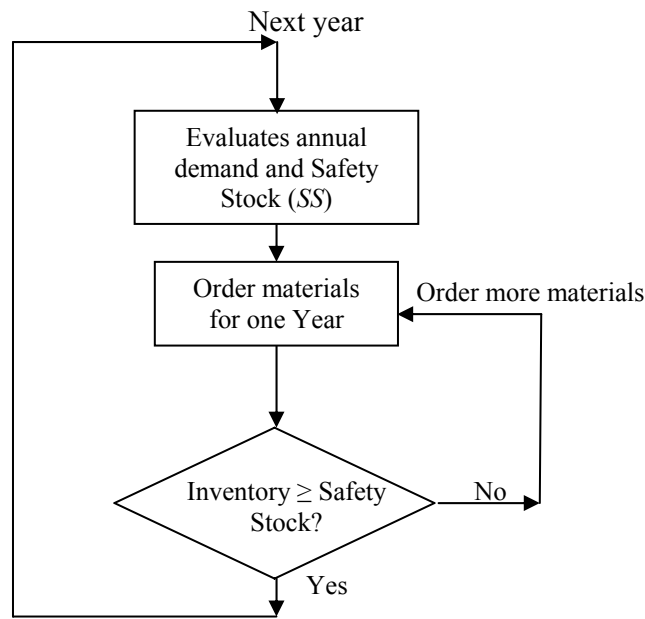

Figure 1. Current inventory control model in SLC

According to its producing scheduling, the annual steel product is evaluated in advance, and the inventory manager would order all materials at one time for one year and check the inventory with safety stock based on previous experience and production demand. Since there is not enough storage for all annual materials, the company only keeps enough materials for feeding production demand for a certain period. The orders will determine if the inventory level becomes too low. In delivery from the supplier (upstream participant) to the company, the existing railway connects the mine located in the supplier's province to the raw materials plant and provides direct access to the venues. Trains connecting the venues of the supplier and SLC will make one trip per day, and trucks will be available between train stations and the venues or the mining

supplier and venues, as the case company has its local mining supplier. A lot of trains and trucks will operate in the region each day. Since the nationwide railway system is integrated and managed by the government, there will be no shortage of available trains usually. This provides the fixed lead-time between the raw materials plant placing an order and receiving it. Normally, the company would rather order a full container than a less-than-full container, since the transportation cost will not then need to include a penalty cost per item for not using a full container. In consequence, the delivery from the supplier will be only considered with full containers.

Obviously, the old inventory policy is completely a push system. Before, this old inventory policy might have been effective when the company only had push production and did not take fluctuating steel and iron markets into account. However, along with the growth of iron and steel-making in recent years, SLC has become a steel cooperative that has a multi-stage iron and steel supply chain, including iron-making, steel-making, and with changing iron and steel markets. The development of the supply chain in SLC is due to there being two types of participants in the demands—the company's own inner steel-making and the customers of the iron and steel markets. The company's supply chain has been shifting to an incomplete push system. Under the current circumstances, the demand from the inner steel-making mill may be stable or uniform, but, unfortunately, the real market (iron and steel) demand is not so constrained or so tidy; the demand fluctuations occur quite often due to the fluctuating steel and iron markets, so it is a stochastic demand case or demand with imprecise fluctuation case. This fluctuating demand in steel and iron markets is related to fluctuations in the construction industry, car industry, even the military industry, and so on. These industries sharply fluctuate according to the situation of the developing economy, military situation and even regional conflicts. Thus, as a modern iron and steel maker, SLC has to be concerned with demand fluctuations in inventory management and in the iron and steel markets. Moreover, it is obvious that it does not make good economic sense to order a whole year's materials, especially when the company's supply chain is shifting to an incomplete push system, the company's old inventory policy is not an appropriate model, and the weak ability of the old policy to

counteract fluctuating demand caused by changing markets is not adapted to the developed supply chain and incomplete push production. There is no doubt that SLC needs to improve its raw materials inventory and ability to counteract fluctuating demand.

Quite understandably, these problems are almost self-evident. In order to provide competitive advantage in the marketplace, SLC should respond to tougher times by seeking reductions in the costs of raw materials inventory and improving the ability to counteract demand fluctuations. The expectation of this research is that the FICM will help to improve the company's supply chain inventory management and achieve cost reduction and improved ability to counteract demand fluctuations when applied in situations of stochastic demand and demand with imprecise fluctuation caused by the fluctuating market. An alternative model of inventory policy is needed to effect these changes.

1.3 The Research Questions and Research Approach

Firstly, some concepts concerning this research will be clarified, as follows:

Inventory policy: according to Taha, an inventory policy answers two questions: 1. How much to order? And 2. When to order? (Taha, *Operations Research, an Introduction*, Macmillan Publishing Company, 6th Edition. p 439).

Inventory control system: this is an integrated package of software and hardware used in warehouse operations, and elsewhere, to monitor the quantity, location and status of inventory as well as the related shipping, receiving, picking up and putting away processes. In common usage, the term may also refer to just the software components. (http://en.wikipedia.org/wiki/Inventory_control_system)

(s, S) policy: this represents one optimal inventory policy based on the basic EOQ model. In the continuous or period review, when the inventory level (S) is less than ($<$)

the re-order point (s), an order is placed, otherwise (\geq) applies, i.e., do not order. As Taha states, “The optimality of the (s, S) policy is guaranteed because the associated cost function is convex. If the convexity property does not hold, the (s, S) policy is not optimal.” (Taha, *Operations Research, an Introduction*, Macmillan Publishing Company, 6th Edition. p 599.)

Fuzzy logic: fuzzy logic is derived from fuzzy set theory dealing with reasoning that is approximate rather than precisely deduced from classical predicate logic. It can be thought of as the application side of Fuzzy Set Theory, dealing with well thought-out real world expert values for a complex problem (Klir 1997).

Fuzzy controller: it uses rules to model process knowledge in an explicit way. Instead of designing algorithms that explicitly define the control action as a function of the controller input variables, the designer of a fuzzy controller writes rules that link the in-out variables with the control variables by terms of linguistic variables (Zimmermann, *Fuzzy set theory and its applications*, 1985).

Bullwhip effect: is defined as an increase in variability as fluctuations travel up the supply chain. Typically, suppliers and retailers observe that, while customer demand for specific products does not vary much, inventory and back-order levels fluctuate considerably across their supply chain (http://en.wikipedia.org/wiki/Bullwhip_effect). The demand-magnification effect in this research is similar to bullwhip effect.

Supply Chain Management (SCM): Supply chain management (SCM) is the process of planning, implementing, and controlling the operations of the supply chain with the purpose of satisfying customer requirements as efficiently as possible. Supply chain management spans all movement and storage of raw materials, work-in-process inventory, and finished goods from point-of-origin to point-of-consumption (http://en.wikipedia.org/wiki/Supply_Chain_Management).

Supply Network: Supply network is a pattern of temporal and spatial processes carried out at facility nodes and over distribution links, which adds value for customers through the manufacture and delivery of products. It comprises the general state of business affairs in which all kinds of material (work-in-process material as well as finished products) are transformed and moved between various value-add points to maximize the value added for customers. A supply chain is a special instance of a supply network in which raw materials, intermediate materials and finished goods are procured exclusively as products through a chain of processes that supply one another (http://en.wikipedia.org/wiki/Supply_network).

Demand Driven Supply Network: A demand driven supply network focuses on technologies and business process improvements that can elevate performance of all aspects of the supply chain. This includes how information flows through the extended manufacturing enterprise - across internal functional areas and into external partners, including buyers and sellers. The supply demand network (SDN) in this research is similar to demand driven supply network (<http://www.managingautomation.com/maonline/channel/DemandDrivenSupplyNetworks/>).

Figure 2 illustrates the research framework of this research. This research effort seeks to develop and apply an effective inventory control model for the raw material plant, which belongs to Company “SLC”. In the thesis a FICM with a fuzzy logic controller will be introduced and compared with SIMM. The associated research questions are the following:

Question 1: Can the FICM be combined with the (s, S) policy to reduce the total inventory cost relative to SIMM?

Question 2: Can FICM reduce the ordering and shortage costs (and the total inventory cost) in case of (1) stochastic demand and (2) imprecisely fluctuating demand relative to SIMM?

Question 3: Can the FICM reduce the demand-magnification effect caused by the SIMM in a multi-stage supply-demand network?

Question 4: Can the FICM show superior performance to the (s, S) policy in a multi-stage supply-demand network?

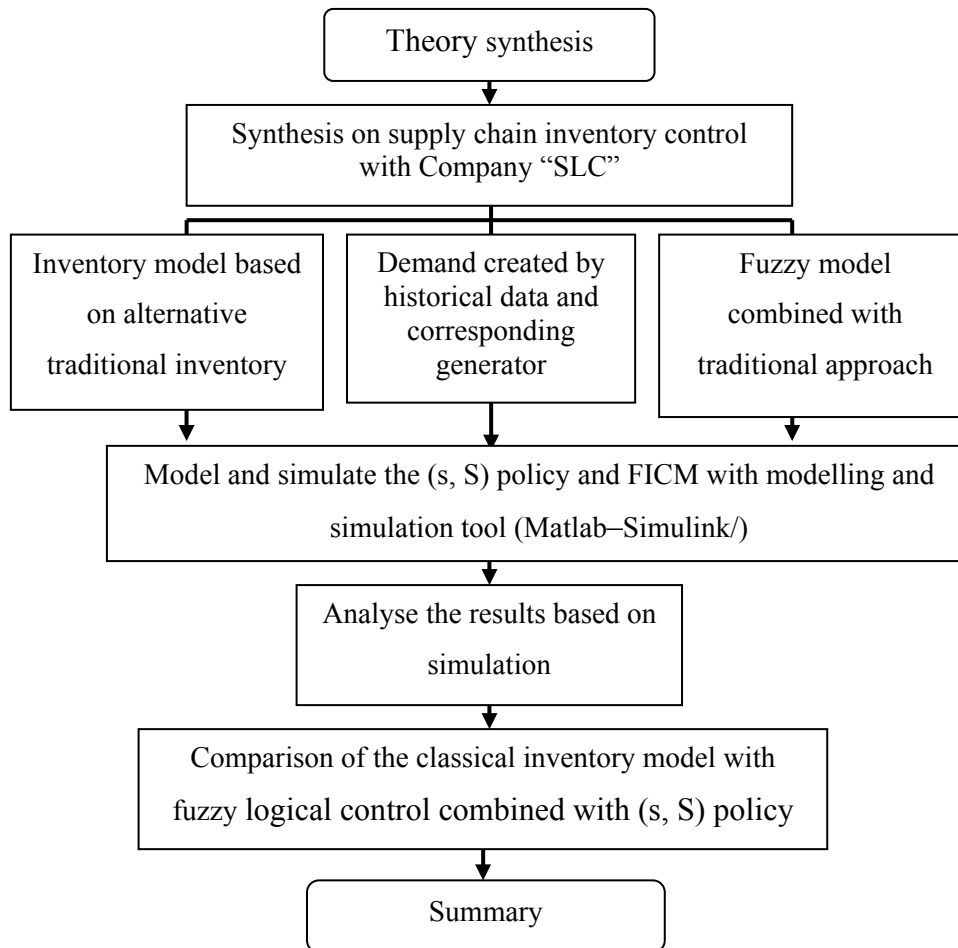

Figure 2. Research framework

Answering the above questions involves finding the answers to a number of subordinate questions. First, the traditional inventory models are based on the minimization of expected costs, both direct and indirect, and the traditional methods of inventory control use EOQ models, while the extension (s, S) policy based on the basic EOQ model relaxes some assumptions of other EOQ models, and is one of the more advanced. This model is similar to the existing inventory policy in SLC, thus this research needs to first

study the performance of the (s, S) policy. Secondly, can the extension (s, S) policy be combined with the fuzzy logic controller and a FICM be proposed? Third, how well does the FICM perform in the different demand cases (stochastic demand case and demand with imprecise fluctuation case)? Under some conditions and the data provided by the case company, can the proposed fuzzy control model be shown to offer a better inventory management model than the crisp inventory classical model?

Preparation for answering these questions addressed three key issues. The first issue was to establish an objective inventory model based on inventory theory for Company “SLC”– to specify how the model realizes the optimisation of the inventory level and cost, and how the model improves the ability to counteract the demand fluctuations when the model is used in multiple supply demand networks. Secondly, the research established an inventory model based on a fuzzy logic controller combined with a traditional inventory model for the SLC. Third, the fuzzy and classical inventory control models were run by simulation, finding answers to the questions posed above, and showing how the system achieved its performance while it was operating.

1.4 Contribution of the Research

The research provides four main contributions to supply chain management in the iron and steel industry. Firstly, it provides a cost-effective inventory model to the supply chain based on a synthesis of a traditional inventory model and a fuzzy logic controller, with the proposed FICM benefiting from traditional and modern issues for the real iron and steel industry. Since this research is based on an actual iron and steel company, and the proposed FICM is not much more complicated than the one currently in use in the company, it will be easily used in the iron and steel industry. Secondly, beside the uniform demand case that the case company has been using, the proposed FICM can be applied in cases of stochastic demand and demand with imprecise fluctuation caused by changing markets when the steel supply chain is concerned with fluctuating demand that the company has never taken into account in its old inventory policy. Thirdly, the FICM demonstrates the new attempt in the iron and steel industry. Its application to the supply

chain in the iron and steel industry provides a new prospect in combining traditional with modern issues. Fourthly, the synthesis of the modelling effort in the case study of a real company significantly increases its relevance and therefore perceived value to supply chains in real industry. The proposed inventory control model will provide a basis for the supply chain inventory management of iron and steel-makers, and when iron and steel companies and other industries can have complete data and apply them in the fuzzy model; it will also be possible to extend to other industries.

2 LITERATURE REVIEW AND DEVELOPMENT OF THE TRADITIONAL INVENTORY MODEL

2.1 Overview

This chapter presents a review of the literature relevant to issues raised in the problem description and in the methodology sections, and lays out the general approach used to address those problems. The discussion first starts with the classical inventory control models in the supply chain and their development, using optimisation techniques in solving inventory problems. Next, due to the limitation of classical inventory control models in industry, it moves on to the development of inventory control systems in supply chain management using fuzzy control techniques. Among the relevant literature reviewed, some research studies apply fuzzy set theory in managing inventory strategies to counteract demand fluctuations: these are presented and discussed. Finally, an inventory control model is suggested in accordance with issues arising from the review of the development of traditional inventory model and the fuzzy logic applied in inventory management control, and these issues are developed to propose an FICM for the company.

2.2 Inventory Control Model and its Development

Inventories deal with holding sufficient stocks of goods (e.g. parts and raw materials), which will ensure the smooth operation of a production system or a business activity. Historically, inventory has been viewed by business and industry as both an asset and a liability. Firstly, too much inventory consumes physical space, creates a financial burden, and increases the possibility of damage, spoilage and loss. Also, too much inventory frequently compensates for sloppy and inefficient management, poor forecasting, haphazard scheduling, and inadequate attention to process and procedures. Furthermore, it causes more environmental problems in the iron and steel industry. Secondly, too little inventory disrupts manufacturing operations, causes chaos on the

shop floor, and increases the likelihood of poor customer service. In many cases good customers may become irate and take their business elsewhere if the desired product is not immediately available. From that standpoint the only effective way of coping with supply chain inventory is to minimize its adverse impact by striking a “happy medium” between the two extreme cases (Taha 1962).

Since this research is specifically about raw materials inventory in the steel industry, the proposed model employed will use the extension (s, S) policy that is based on the traditional EOQ-type model, and the review will start with EOQ model and its development.

The traditional methods of inventory control use EOQ models. However, the basic EOQ presented in 1913 with the Harris model was based on the assumption that demand is constant, no shortage was considered and the lead-time was zero or constant. These assumptions are not realistic in real life applications. The EOQ model does not take into consideration the demand pattern of the end product before determining the inventory levels of parts and materials. Therefore, besides the basic model, many authors added extensions to the basic EOQ model, for example:

- Lead-time: allowing a lead-time between placing an order and receiving it introduces the problem of when to re-order (typically at some stock level called the re-order level).
- Stock-outs: allowing stock-outs (often called shortages) means that no stock is currently available to meet orders. Often replenishment of ordering is not received all at once.
- Buffer (safety) stock: some stock is kept back to be used only when necessary to prevent stock-outs.
- Probabilistic demand: instead of a constant depletion (demand) for stock, allow probability distributions (Janssen 1998).

Here we summarize the main findings presented in the literature, which develop the basic EOQ model when it is applied in inventory control. The selected references highlight significant contributions, but are not meant to be all-inclusive.

The current literature consists of both classes, which are deterministic and stochastic inventory control models. Deterministic models can be further sub-divided into stationary versus dynamic models. The stationary models correspond to the classical economic order quantity (EOQ), which was mentioned earlier. As early as 1967, Schrady developed an extension to this model that includes item returns. His analysis seeks optimal lot sizes for the recovery channel and 'virgin' procurement, both of which involve fixed costs. More recently, variants to this model have been discussed, e.g. by Richter (1996) and Teunter (2001). For the dynamic models, Wagner and Whitin (1958) first proposed an optimal algorithm to solve the single item, single-level, uncapacitated economic lot size problem. In their model, demand figures for future periods were assumed to be deterministic. The algorithm is based upon three theorems that give some important clues about the structure of optimal solutions:

1. Initial inventory can always be assigned to zero.
2. At optimality, a production volume is either zero or a sum of demands for several periods.
3. A setup results in a production quantity that satisfies all demand until the next production setup

Some researchers have suggested several extensions to the classical Wagner-Whitin model. The Silver-Meal heuristic model (1973), in particular, tries to identify the production setup points by including demand figures one by one in the order. The effectiveness of their model is to make the simplicity to Wagner-Whitin model. Beltran & Krass (2002) show that return flows increase the combinatorial complexity of this model. In particular, the fundamental zero-inventory-property is lost.

With the class of stochastic inventory model, two streams of contributions can provide the basis for investigation in this research. Within this stream one may distinguish

between periodic review and continuous review approaches (Mahadevan 2003; Taha 1962; Wells 2001). Another important differentiation concerns single versus two-stage (echelon) models. In the single stage case, the analysis is limited to end-items stock, while the two-stage case involves a more detailed picture of the recovery channel, distinguishing end-item and recoverable stock. This research refers to the stream between periodic review and continuous review approaches.

For the periodic review approaches, Whisler (1967) analysed the control of a single stock point facing stochastic demand and returns. He showed the optimality of a two-parameter policy that keeps the inventory level within a fixed bandwidth in each period by means of disposal and new supply. Both actions are immediate and the costs are purely linear. Simpson (1978) extended this model to a two-stage situation. The optimal policy then relies on three critical numbers that control the disposal, remanufacturing, and new supply decision, respectively. Further, Fleischmann & Kuik (1998) provided another optimality result for a single stock point. They show that a traditional (s, S) policy is optimal if demand and returns are independent, recovery has the shortest lead-time of both channels, and there is no disposal option. Related models have also been analysed by Kelle & Silver (1989), Cohen et al (1980), and Mahadevan et al (2003). Johansen and Hill (2000) developed a solution procedure using asymptotic renewal theory and policy improvement for a continuous demand distribution and only a single replenishment order may be outstanding at any time and the lead-time is fixed. Later, Johansen (2001) explored optimal and near optimal base stock policies for lost sales models with negligible set-up costs and constant lead times for a discrete demand and when more than one order may be outstanding at any time. Chen et al (2001; 2003) developed the optimal pricing and inventory control policy in periodic-review systems with fixed ordering cost. This research considers a periodic-review pricing and inventory control problem for a single item retailer. Under a mild assumption on an additive demand function, at the beginning of each period, (s, S) policy is optimal for replenishment, and the optimal price will depend on the inventory level after the replenishment decision has been made. Based on their research, they suggest that the

fixed ordering cost has a significant effect on the optimal policy variable values. Specifically, as ordering cost increases, s decreases, while S increases.

For continuous review approaches, Moinzadeh and Nahmias (1988) consider a continuous review inventory model with two supply modes differing in lead times and costs, and they propose a heuristic reorder point–order quantity policy for both supply modes. Mohebbi and Posner (1999), and Johansen and Thorstenson (1998) propose variations of this policy. Ramasesh et al. (1991) offer an analysis of a reorder point–order quantity policy in a model with deterministic demand, in which each order is split equally across two vendors differing in stochastic lead times. Rosling (1997) also provides a solution methodology for the (r, Q) model with normal demand and a fixed lead–time when the complications of negative demands are ignored. Muckstadt & Isaac (1981) consider a single stage model, where the recovery process is modelled as a multi–server queue. Van der Laan, Dekker, & Salomon (1996) developed an alternative approximation for this model and extend it with a disposal option. Finally, Van der Laan et al. (1999) provide a detailed analysis of the corresponding two–stage model. Namit & Chen (1999) present two algorithms to solve the (r, Q) inventory model for gamma lead–time demand without using tabulated values. Tyworth & Ganeshan (2000) demonstrate the relevant simplicity of solutions and discuss further considerations when those models are applied in practice. Their research presents a practical method of estimating the parameters of the gamma distribution and describes a convenient alternative formulation of the current model. Other related models about continuous review have also been analysed by Rosling (2001; 2002).

In summary, most of the work on development with EOQ models, both in periodic review and continuous review approaches, focuses on the structure of optimal policies for specific cases. This highlights the fact that practical implementation calls for more efficient evaluation of policy alternatives, and therefore for approximations to the optimal policy. It is evident from the above discussion that there are some limitations to the research on EOQ inventory models. First, most studies assume that the company (vendor) faces a constant, deterministic demand. Second, the treatment of the inventory

management of the vendor is a gross simplification of the actual situation, and of incapacitated situations. Third, with the emphasis on strict assumptions in the EOQ model, order policy would be difficult to justify as a matter of policy. However, it must be noted that EOQ can be successful only when demand is stable over time. In situations where demand is dynamic (which is very often the case in real life) the research direction outlined by advanced theory is likely to be useful.

Therefore, among EOQ-type models the extension (s, S) policy based on traditional inventory model will be one of the choices in this research, as this model can be used with mild assumptions and demand represented with a PDF (Probability Density Function). It will provide a basis for the proposed inventory model for the company. Further, modern fuzzy set theory that is suggested to combine with this basic inventory policy can be of benefit in improving the supply chain inventory control in a company, since fuzzy logic control based on fuzzy set theory has the features to cope with imprecise information, faster and simple programs, and is fairly robust, and has been applied to problems in engineering, business, medical and related health sciences, and natural sciences, and there have been successful applications and implementations of fuzzy set theory in production management. As a result, the combination of the benefits from traditional inventory models and modern fuzzy control issues is taken into the research. Hence, literature on fuzzy set theory in production and supply chain management will be mainly reviewed in the following section.

2.3 Fuzzy set theory Applications in Supply Chain Inventory Management

This section provides a survey of the application of fuzzy set theory in supply chain management. Fuzzy set theory has been studied extensively over the past 40 years. Most of the early interest in fuzzy set theory pertained to representing uncertainty in human cognitive processes (see, for example, Zadeh, 1965). This theory has demonstrated many advantages in real-world applications, e.g. in engineering, business, and many industries.

The use of fuzzy set theory as a methodology for modelling and analysing decision systems is of particular interest to researchers in production management because of the ability of fuzzy set theory to quantitatively and qualitatively model problems which involve vagueness and imprecision. Karwowski et al. (1986) present and identify the potential applications of fuzzy set theory to areas of production management, including new product development, location and layout of facilities, production scheduling and control, inventory management, quality and cost benefit analysis.

To gain a better understanding of the use of fuzzy set theory in supply chain inventory for the case study and to provide a basis for fuzzy inventory control, the literature of fuzzy set theory in production management is reviewed. There have been many successful applications and implementations of fuzzy set theory in production management. Fuzzy set theory is recognized as an important problem modelling and solution technique. It provides the possibility of using fuzzy set theory in modelling and simulation of supply chain inventory management. Among a number of publications, Guiffrida and Nagi (1997) summarize fuzzy research findings in production and inventory planning according to the application and methods found in a number of journal articles and books. They review the literature of fuzzy set theory in production management, classify the literature based on the application of fuzzy set theory to production management research; and identify future research directions. Inventory management is one class in their review, and their main fuzzy research findings in inventory management are summarized in Table 2.

In Table 2, fuzzy set theory has been applied to problems in inventory management. Since the inventory control model requires demand or demand forecasts as its input parameters for inventory related costs such as carrying, order, shortages and backorders, it causes difficulties in precisely evaluating each of these terms. The studies in Table 2 demonstrate the usefulness of fuzzy set theory in modelling and solving inventory problems when data and objectives are subject to potential ambiguity.

Table 2. Fuzzy research findings in inventory management (Guiffrida and Nagi 1997)

Author(s)	Application	Method
Lee et al. (1991)	MRP lot-sizing	Develops fuzzy Silver–Meal, Wagner–Whitin, and part–period balancing algorithms
Lee et al. (1991)	MRP lot-sizing	Develops fuzzy part–period balancing algorithm
Park (1987)	Economic Order Quantity Model	Determines EOQ with fuzzy ordering cost and holding cost
Sommer (1981)	Withdrawal from market	Satisfies fuzzy inventory and production capacity levels during withdrawal

Furthermore, besides the reviewed literature by Guiffrida and Nagi, there are some other researchers who have started to focus on inventory management in recent years, and these will provide evidence that the iron and steel industry may use fuzzy set theory in its supply chain raw materials inventory.

Esogbue and Liu (1997) developed fuzzy criterion dynamic programming to multidimensional case for an open inventory network whose background deals with stochastic multi–location inventory systems and multi–reservoir operations. They prove the existence, uniqueness and stability theorems of solutions to their model and give an illustrative example.

Hung et al. (1996) developed a fuzzy–control–based Quick Response (QR) re–order scheme for seasonal apparel. The fuzzy–control scheme uses Mamdani inference logic. A stochastic computer simulation model of the apparel–retailing process is employed to evaluate the performance of the proposed scheme compared to that of existing approaches.

Ballard et al. (1996) propose a fuzzy control system based on the (Q, r) frame. They compare the performance and implementation of two inventory control methodologies, which are the classic (Q, r) inventory model and a fuzzy control system. In the same year, the other researchers in the same group, Zhu and Bart (1996) also developed an

inventory controller using fuzzy logic, which is similar to that in the study by Ballard et al. (1996). They just use the (s, S) policy to replace the (Q, r) model, the fuzzy part is the same. Both projects use the fixed expression to calculate s and S according to different distributions and do not calculate them according to varying demand and previous inventory level, i.e. their model does not consider the inventory level as a dynamic variable according to dynamic demand, whatever the distribution is. Also their model does not show multi-items and lead-times. In view of these points, inventory level will use the proposed model in this research as a dynamic input, whatever the distribution is. The calculation for s and S will consider more factors. More details will be discussed in subsequent chapters.

Li et al (2002) developed a fuzzy model in a single-period inventory system with two types of uncertainties, one arising from randomness and from fuzziness, which can be characterized by fuzzy numbers. They developed two models, in one the demand is probabilistic, while the cost components are fuzzy, and in the other the costs are deterministic but the demand is fuzzy. In each, the objective is maximization of profits, which is fuzzy, and optimisation is achieved through fuzzy ordering of fuzzy numbers. Mondal & Maiti (2003) used a soft computing approach to solve non-linear programming problems under a fuzzy objective goal, and resources with/without fuzzy parameters in the objective function for multi-item fuzzy models use GA (genetic algorithms).

In the related literature review, the bullwhip effect is a special class in supply chain management. As one of the inputs of inventory management, customer demand plays a key role in achieving effective inventory management. However, demand fluctuations from the bullwhip effect vary significantly between industries. Several scholars (Lee 1997, 2000; Disney & Towill 2003; Forrester 1961; Fisher 1997; Burbidge 1984; Towill 1991, 1994, 1999) have worked with the bullwhip effect and the demand fluctuations that it results in. According to prevailing opinion, Lee et al. (1997a) have identified four basic determinant reasons for the bullwhip effect:

- Quality of the forecast and its update frequency

- Re-order frequency and re-order batch size (order quantity)
- Special price schemes, leading to speculative buying
- Expectation of shortage, leading to protective buying

The demand fluctuations are hard to monitor and control. Based on studies (Lee 1997, 2000; McCullen & Saw 2001; Donovan 2002; Huang 2003; Li 2004), the following list gives related counteractions for these causes of the bullwhip effect:

- Information sharing: including point of sale data (POS), EDI, computer aided ordering (CAO).
- Channel alignment: including vendor managed inventory (VMI), direct sales, outsourcing, and consolidation.
- Operational efficiency: including lead-time reduction, set-up time reduction and ABC approach.

Most recent research has focused on how to avoid and eliminate demand fluctuations by an information sharing strategy. Huang et al. (2003) researched the impacts of sharing information on the supply chain dynamics, and reviewed recent representative papers since 1996. Their review shows that the benefits of information sharing are significant, especially in counteracting the bullwhip effect. However, this may not be beneficial to some supply chain entities, owing to the high adoption cost of joining an inter-organizational information system, and unreliable and imprecise information. In this case, the company must consider more effective counteractions to demand fluctuations. Warburton (2004) proposed analytical solutions that agree with numerical integrations and previous control theory results. These depend on exact expressions being derived for the retailer's orders to the manufacturer. But these exact expressions are normally difficult, or even impossible, to build within an entire supply chain. The approach is quite general, but limited: applicable to a wide variety of inventory management for several different reasons.

To research the bullwhip effect case, there are some researchers who select two-stage supply chains or use a two-stage supply chain system, elucidating the relevance method

of counteracting demand fluctuations or bullwhip effect. For example, Disney and Towill (2003) proposed a vendor–managed inventory and bullwhip reduction in a two–level supply chain. Their research focuses on one supplier, one customer relationship, and particular attention is given to the manufacturer’s production scheduling activities. They investigated each of the potential sources of bullwhip identified by Lee et al. (1997a, b), and show that it is possible to completely avoid two causes of bullwhip altogether. It is also possible to reduce the impact of other sources of bullwhip. The research shows that VMI (vendor managed inventory) can be of great benefit to the vendor or supplier in a VMI relationship if they correctly use inventory and sales information in the production and inventory control decision–making process. Narasimha and Rahul (2005) present a supply chain structure analysis and design method. Their research approach uses a wide system dynamic to bring out structural peculiarities and the macro level behaviour of supply chains. They use a two–echelon supply chain system to elucidate the method that they claim can easily be deployed in supply chains and can also be used to justify information technology investment decisions. Moreover, Boute et al. (2005) consider a two echelon supply chain and focus on an inventory replenishment rule that reduces the variation of upstream orders and generates a smooth ordering pattern. The research focuses on an inventory replenishment rule that reduces the variation of upstream orders and generates a smooth ordering pattern. The case company in this research is also using a one and two–stage supply chain system; however, the counteracting demand fluctuations will apply the proposed FICM.

Some research studies (Petrovic et al. 1999, 2001; Carlsson et al. 2000, 2001, 2002; Giannoccaro et al. 2003, 2005; Wang et al. 2005) apply fuzzy set theory in managing inventory strategies. Carlsson and Fuller (2001) propose a fuzzy logic approach to reduce the bullwhip effect, and their fuzzy logic model is based on numerous theorems, processes of demand signal processing, and is used in the paper industry. Petrovic et al. (1999) developed a supply chain fuzzy model to determine the order quantities for each inventory in the supply chain in the presence of uncertainties. According to the obtained order–up–to levels for all sites, a simulation approach was developed to evaluate the

performance of the entire SC. Later, Petrovic et al. (2001) considered fuzzy lead-times in the SC simulation model developed in their previous research. However, their fuzzy SC model was still isolated and cannot be used to evaluate the entire SC directly. Giannoccaro et al. (2003) propose a SC inventory policy using a periodical review policy based on the concept of fuzzy echelon stock. However, as Wang (2005) says, Petrovic's model could not estimate the influences of inventory policy (e.g. order-up-to level) determined at an upstream site on downstream sites, although the external supplier's reliability was considered in their model. Thus, Petrovic's fuzzy model could not directly evaluate the performances of an entire supply chain and Giannoccaro's model did not consider material lead-times and the supplier's reliability and could not estimate the effects of supply delay from an upstream site on downstream sites. Similarly, Giannoccaro's fuzzy model could not evaluate the performances of an entire supply chain directly. Aimed at the weakness of the above models, which could not evaluate the performances of an entire supply chain directly, Wang and Shu (2005) have developed a fuzzy decision model to evaluate supply chain performances and select suitable inventory strategies. In their model, a genetic algorithm approach is developed to determine the order-up-to levels of all fill rates of the finished product fulfilling the target at the same time. However, Wang's (2005) fuzzy decision model does not involve the performances of the bullwhip effect and inventory sensitivities caused by demand fluctuations, even though the model evaluates most supply chain performances.

In brief, fuzzy set theory has been applied to problems in inventory management, especially in EOQ models. As per the review above, the methods found in the traditional inventory model and fuzzy set theory inventory literature are important from a theoretical perspective. From the review of the fuzzy part, many researchers are looking for new solutions with fuzzy set theory to compensate for the shortcomings of EOQ. Most of them, however, have considered different fuzzy algorithms to improve inventory control, even though some methods have considered combining EOQ and a fuzzy algorithm, like the fuzzy control system based on the (Q, r) frame by Ballard et al. (1996) and the inventory controller using fuzzy logic by Zhu and Bart (1996), but few projects have considered inventory level as a dynamic variable according to dynamic

demand and other factors. From the review of the bullwhip effect part, most models do not involve the performance of the bullwhip effect and its impact on inventory level caused by demand fluctuations, even though the model has evaluated most supply chain performances. As a result, this research considers that modern fuzzy inventory control based on fuzzy set theory combined with the extension (s, S) policy is not only another choice for the case company in considering dynamic inventory level according to dynamic demand, but also makes it possible to directly evaluate the performance of each stage in an entire supply demand network, including the related performance with costs and inventory. Overall, this research will be about raw materials inventory for the iron and steel industry and will compare extension (s, S) policy with the fuzzy logic control combined with (s, S) policy, which takes into cognizance the previously related review, as well as injections of new issues, and will apply it to the iron and steel industry, and set out to explore the benefits of counteracting demand fluctuations with the proposed inventory model and investigate how the FICM can counteract demand fluctuations, evaluate and improve inventory performance. Finally, the research will provide an effective fuzzy supply chain inventory model for Company SLC.

3 ANALYSIS AND EVALUATION OF TRADITIONAL INVENTORY MODEL

3.1 Overview

The objective of the chapter is to provide an investigation and comparison of inventory control between the different developed inventory models based on the basic EOQ type models. Since Taha (1968, 1971, 1972, and 1982) et al have made a summary of a series of the inventory models, including the basic EOQ and its developed inventory models, this chapter will provide a unifying framework for investigating all the classical single stage inventory models. From this observation it is possible to provide the mathematical expressions for cost functions with some assumptions commonly used within the field of inventory control. Among the developed models, the extension (s, S) policy will be shown to provide a suitable model for inventory management in comparison with the basic EOQ model and its extension model.

3.2 Supply Chain Inventory Management and Inventory Control Policy

3.2.1 Common Problems in Supply Chain Inventory Control

Inventory could be considered an itemized report or record of a product that will be used to satisfy future demand for that product. It requires a policy inventory control. According to Section 1.3, this policy may involve some items such as when to order, how much to order, what products to order, and the best ordering policy for a warehouse to minimize cost, while meeting demand. The supply chain inventory system control will give the answer.

A supply chain inventory system is a set of policies and controls that monitor the amount of inventory level and determines what level should be maintained, when it should be ordered, and how large the orders should be.

The purposes of inventory include the following items:

1. To maintain the independence of operations.
2. To meet variation in product demand.
3. To allow flexibility in production scheduling.
4. To provide a safeguard for variation in raw material delivery time.
5. To take advantage of economic purchase–order quantity.

The classical economic order quantity model (EOQ) is an order policy to determine the amount of order level and it is easy to understand. As has been noted, there were always some assumptions that the demand was continuous and constant. Normally, it is a good approximation of the actual demand; however in many situations this is not the case. The demand varies and orders come in clusters. Under such conditions the traditional EOQ can be arbitrarily bad, because its assumptions are not valid. Under such conditions, one must take the demand variations into consideration in determining the order quantity. Thus some inventory policy extensions to the EOQ have been investigated – advanced model in this chapter including the (s, S) policy. Using calculus, the derivative of the total cost function is taken and the derivative (slope) set as equal to zero for these models. Moreover, the (s, S) policy is regarded as one of the appropriate inventory policies in modern large industries such as textiles, iron and steel and car industries.

A basic introduction of inventory control will be given before discussing the inventory models with a probabilistic demand (also called stochastic demand when one explains how the demand is generated) or deterministic demand process. Inventory control takes into account several issues including statistics (data analysis, inference, parameter estimation, etc), informatics (to maintain a record of the inventory in an adequate data base) and operational research (modelling and determination of an optimal or a reasonable order policy). Different types of inventory systems may be considered such as pure inventory systems where only the inventory itself is taken into account. Other systems are production inventory systems where production interactions are included, and distribution inventory system which involves the allocation of the available inventory, etc. In these items, pure inventory and its control will be studied. Each

particular problem has its own characteristics and the most important ones can be listed as the following:

Planning horizon: this is the time over which the inventory level is controlled. This horizon may be finite or infinite, deterministic or stochastic.

Number of items (products): an inventory system may involve more than one item (product). The case is of interest mainly if some kind of interaction exists between the different items. For example, the items may compete for limited floor space or limited total capital.

Products: the inventory system may include one or many products. The items of these products, which are stored, may be different from each other in many ways and interactions may take place among the different items. There are products that have to be stocked under controlled conditions, some are perishable or subject to obsolescence; others can be stocked and indefinitely exposed to the elements without deterioration. In case of interactions, some items may be substitutes for each other, or may compete for limited capacity.

Demand process: the demand process may occur continuously in time or it may only occur at certain fixed points in time. It may consist of discrete sizes (1, 2...) or continuous sizes (0, ∞). Moreover, the inventory models can be classified in four general categories with respect to the nature of demand (Table 3).

Table 3 illustrates the different classifications for demand as they are normally assumed in inventory systems. A deterministic demand may be static, in the sense that the consumption rate remains constant with time, or it may be dynamic, where the demand is known with certainty, but varies from one time period to another. The probabilistic demand has two similar classifications: the stationary probabilistic case, in which the demand is a random variable having a probability distribution, and PDF–probability density function, which is the same for each period; and another case is the non–

stationary probabilistic, where the demand is a random variable having a probability distribution, and probability density function varies with the period.

Table 3. General classifications with respect to characteristics of demand

DEMAND	CHARACTERISTIC	DEMAND RATE	
		Same for Each Period	Varies with Period
Deterministic	Known, Constant	Static Deterministic	Dynamic Deterministic
Probabilistic	Random Variable Having Probability Distribution	Stationary Probabilistic	Non-stationary Probabilistic

“It is rare that a deterministic static demand would occur in real life” (Taha, Operations Research, an Introduction, Macmillan Publishing Company, 5th Edition. p 483). This situation may be regarded as the simplest case. The most demand can perhaps be represented by the probabilistic non-stationary distribution. However, from a mathematical standpoint the resulting inventory system will be complex. Normally, people select the deterministic demand distribution or stationary probabilistic demand distribution with some assumptions.

Although the type of demand is a principal factor in the design of the inventory model, the following factors may also influence the way the model is formulated:

Lead-time (Delivery lag): when an order is placed, it may be delivered instantaneously, or it may require some time before delivery is effected. The time between the placement of an order and its receipt is called delivery lag or lead-time. Components of lead-time can include delivery time and processing time. Basically, deterministic and stochastic lead-times may be considered. If a deterministic lead-time L is assumed, it may be equal to zero (instantaneous replenishment) or positive. If a stochastic lead-time is taken into account, then the analysis becomes extremely

complicated. In such a case it might happen that orders placed later will arrive earlier at the facility and so issues about order crossing have to be considered.

Review process: the inventory process may be controlled either continuously or periodically. For continuous review (R, Q policy), the level of inventory is known at all moments in time and the re-order decisions can be made at any time. For periodic review (s, S policy), the inventory level is known only at discrete points in time. As an example, at the end of a working week the inventory level can be determined and so the re-order decisions can be made only at these moments. These moments correspond with the beginning of a new period. At the same time, a continuous review system might be had but the re-order decisions can only be taken due to outside restrictions at discrete points in time.

Stock replenishment: although an inventory system may operate with lead-time, the actual replenishment of stock may occur instantaneously or uniformly. Instantaneous replenishment can occur when the stock is purchased from outside sources. Uniform replenishment may occur when the product is manufactured locally within the organization. In general, a system may operate with positive delivery lag and also with uniform stock replenishment.

Shortage: this situation occurs when inventory is unavailable for a customer or for production. The way that the system reacts to this situation is important for the structure of the process. Basically there are two possibilities:

1. Customer: backorder processing (costs of securing a customer are tremendous (mail order)), lost sales and lost goodwill. Due to the shortage, dissatisfied customers will respond in one of four ways: 1) The customer will wait for delivery until the next replenishment but there is a cost associated with waiting that is proportional to the waiting time. This is called the backorder case. 2) There is a fixed charge that occurs whenever the event of shortage occurs during a cycle. The charge is independent of the number of shortages that occur. 3) The customer will wait for delivery until the next replenishment but there is a cost

associated with dissatisfaction that is a constant, independent of the waiting time. This is called the fixed shortage cost case. 4) The customer will not accept delivery at any future time and the sale is lost. This is called the lost sales case. The first three cases involve backordered processing, and the last case involves lost sales and lost goodwill.

2. Production: rescheduling, downtime and delay, expediting, substituting. Due to shortage, inventory is depleted, and new production must at least equal current consumption, and more likely exceed it, in order to replenish inventory. It will result in production stoppage, downtime and delay. The company has to make a new production schedule to substitute original schedule in order to expedite production.

There are different ways to treat this situation:

1. The company fixes portions of the shortage, a portion to be lost and another to be backlogged.
2. The customers are willing to wait, but only for a fixed amount of time.

Costs: Since usually the goal is to minimize some cost function, its characteristics are very important. The most relevant costs are listed below:

Ordering costs: these costs are associated with the outside procurement of material including the cost of writing the order, processing the order throughout the purchasing system, postage, invoice processing, accounts payable processing, receiving and inspection, and transportation, etc. These costs can be divided into two parts: those that are independent of the quantity ordered, and those which are dependent. The first ones are usually called set-up costs, which are fixed costs involved with the placement of an order. The second one is a function of the order quantity and the most common assumption is that these costs are proportional to the order quantity. However, in situations of quantity discounts or price breaks this function can be concave, convex, or

even more general. It is important to note that including a set-up cost in a model increases the complexity considerably.

Holding costs: these costs are the result of carrying inventory in storage and space (production, storage); storage implements (shelves); rent, utilities, security; insurance (space, materials, equipment); taxes, wages; maintenance, damage, operating costs (light, heating) etc. In fact, it is impossible to represent all these costs with great accuracy in the model and so simplifications are needed. The common assumption is that holding costs are proportional to the level of the inventory; it means the holding costs are linear over time. Clearly, the costs of keeping an inventory continuously in a continuous review system (Q, R policy) may be adapted, and it might happen that the costs of keeping an inventory are charged at a period ending inventory levels in a periodic review system (s, S policy).

Purchasing cost: this cost is the cost to purchase the commodity unit price. It becomes an important factor when the commodity unit price becomes dependent on the size of the order. This situation is normally expressed in terms of a quantity discount or a price break, which means the unit price of the item decreases with the increases of ordered quantity. The purchasing cost is neglected in the normal analysis when it is constant. Hence, it is only relevant if quantity discounts apply.

Shortage cost: this cost is the cost charged whenever a shortage occurs, and this may be charged in a complete back ordering system or a lost sales system, or a combination of both. It is sometimes called an emergency order.

Figure 3 (Taha, Operations Research, an Introduction, Macmillan Publishing Company, 5th Edition. p. 482) illustrates the variation of the four cost components of the general inventory model as a function of the inventory level. The optimum inventory level corresponds to the minimum of the sum of the four types of costs. Note, however, that an inventory model need not include all four types of costs, either since some of the costs are negligible or will render the total cost function to components for

mathematical analysis. In application, a cost component can be deleted only if its effect on the total cost model is negligible.

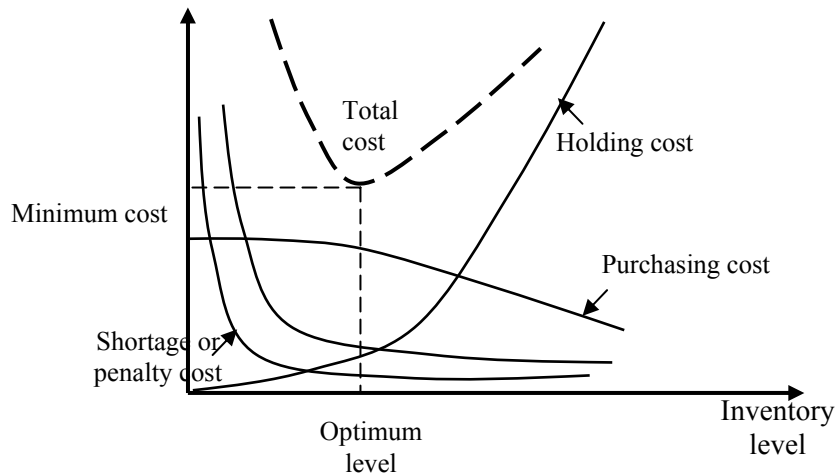

Figure 3. Variation of the four cost components

Service level: this denotes a performance measure of the inventory system and can be defined in various ways. A replenishment cycle is given by the time evolving between two consecutive replenishments of the inventory system. The most common ones are given below:

No-stock-out service measure: this service measure is the probability of no stock-out during a replenishment cycle. A stock-out is defined as the event when the so-called net stock inventory level drops within the replenishment cycle from a non-negative value to a negative value. This measure only takes the appearance of a stock-out into consideration and not the size or duration of the stock-out. This research will define the service level based on this measure and take the case company into account.

The fill rate service measure: this service measure denotes the fraction of demand directly delivered from stock. This measure is very popular in practice. A typical example of this measure is given by the condition that 95% should be delivered directly from stock.

Ready rate measure: this service measure is the fraction of time that the inventory level is positive. It is often used in the control of inventory systems of equipment used for emergency purposes.

These above characteristics imply the basic elements of inventory problems. The optimal control rule may be determined by minimizing the expected holding and ordering cost subject to some service level restriction. Real systems are in general so complex that they cannot be represented with complete accuracy. Therefore, a model with simplifying assumptions must be made. These notes will start with the simplest possible models and by adding all kind of restrictions will increase the complexity of the models.

3.2.2 A Generalized Inventory Model

When dealing with two questions, namely “How much to order” and “When to order”, all inventory models should give the answer to these.

Clearly, the first question of how much to order is expressed in terms of what the order quantity is called. It represents the optimum amount that should be ordered every time an order is placed and may vary with time, depending on the situation under consideration.

For the second question, this depends on the type of inventory system. If the system provides periodic review at equal time intervals, e.g. per week or month, the time for acquiring a new order usually coincides with the beginning of each time interval. On the other hand, if the system is the continuous review type, a re-order point is usually specified by the inventory level at which a new order must be placed. Thus, the solution of the general inventory problem may be presented as follows:

1. Periodic review case: receive a new order of the amount specified by the order quantity at equal interval time [1, 2...]

2. Continuous review case: the inventory is monitored continuously and a replenishment order is placed at continuous time $[0, \infty]$.

In this research, equal time intervals are called periods. When comparing continuous and periodic review from a computational point of view, it is clear that continuous review needs more resources, heavy computation and real-time sampled data than periodic review. Hence, it may only be valuable if good software and good information technology are used in the continuous review case. The periodic review case might be easier to master in industries. Moreover, this case might bring the bullwhip effect problem or demand-magnification effect into a multi-stage inventory system. In this research, good software (E.g. Matlab) and an effective control method (e.g. fuzzy logic control) can be used for this application.

In brief, a periodic review seems easier in computation and practicality than continuous review. In the next section, the single stage inventory policy under different models will be analysed and estimated, including continuous review and periodic review.

Whether continuous review or periodic review, the order quantity and order point are determined by minimizing the total inventory cost that can be expressed as a function of these two variables.

The cost components of inventory models can be classified as stated earlier:

1. The ordering or set-up cost K (Money/order),
2. The purchase cost c (Money/unit),
3. The holding cost h (Money/unit-time period),
4. The shortage or emergency-order cost C_s (Money/unit).

In this section, the inventory model with single-item inventory will first be considered. The total cost of a general inventory model can be summarized as a function of the cost components, as follows:

(Total inventory cost) = (holding cost) + (ordering cost) + (shortage cost) + (purchasing cost)

(Taha, Operations Research, an Introduction, Macmillan Publishing Company, 5th Edition. p. 483)

Therefore, the total inventory costs for the single item can be calculated using the following cost equation:

$$CT = C_h + C_o + C_s + C_p \quad (3-1)$$

Where:

CT = Total inventory cost

C_h = Total holding cost

C_o = Total ordering cost

C_s = Total shortage cost

C_p = Total purchasing cost

Some parameters are defined as follows:

I_1 = Average inventory quantity

I_2 = Number of times of ordering

I_3 = Shortage or emergency-order quantity

I_4 = Average purchasing quantity

K = Set-up (or ordering) cost for placing an order

Money/order

h = Holding cost per unit inventory per unit time

Money /unit/period

g = Shortage or emergency-order cost

Money / unit

c = Purchasing cost per unit

Money /unit

Then, C_h , C_o , C_s , and C_p can be substituted by I_1 , I_2 , I_3 , I_4 and h , K , g , c . When C_h is computed as per unit of time, thus the cost function is replaced by

$$CT = C_h + C_o + C_s + C_p = h \times I_1 + K \times I_2 + g \times I_3 + c \times I_4 \quad (3-2)$$

Note: the purchasing cost is neglected in normal analysis, since it is constant and hence should not affect the inventory level. In this case, the cost equation is given by

$$CT = C_h + C_o + C_s = h \times I_1 + K \times I_2 + g \times I_3 \quad (3-3)$$

But the purchasing cost becomes an important factor when the commodity unit price becomes dependent on the size of the order. This situation is normally expressed in terms of a quantity discount or a price break, where the unit price of the item decreases with the increase of ordered quantity. The company in terms of price-break will be discussed in detail in further chapters.

3.2.3 EOQ Type Models

Deterministic Models with Deterministic Demand

It is extremely difficult to develop a general inventory that accounts for all variations in real systems; even if a sufficiently general model can be formulated, it may not be analytically solvable. The models presented in this section are thus meant to be illustrative of some inventory systems. It is unlikely these models will fit a real situation exactly, but the objective of the presentation is to provide different ideas that can be adapted to specific inventory systems. As discussed earlier, there are some simplifying assumptions used in development of the model. The parameters used during the development of the model can be relaxed or modified.

In the following, the demand process and an inventory control policy will be described in more detail so that a clear picture of development from the simple EOQ to extension (s, S) policy can be obtained, and at the same time an analysis of the model will be presented. Additional assumptions will also be introduced as needed.

Since the demand process is deterministic, some assumptions may be made, as follows:

r = demand rate (demand variation over time)

p = order rate (order variation over time)

The relationship between r and p is based on different cases.

In the model with deterministic demand, it additionally assumes that Lead-time = 0, and $p \geq r$. The analysis and evaluation may be started with the simple system cases for the single item case without the price breaks, finally the extension (s, S) policy is taken into consideration.

Lot Size System: (Basic EOQ model) (Taha, Operations Research, an Introduction, Macmillan Publishing Company, 5th Edition)

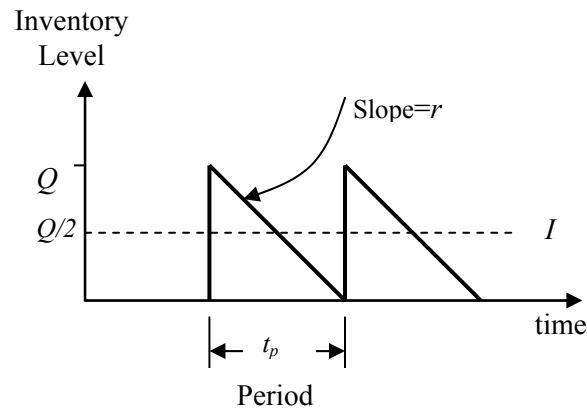

Figure 4. Lot size system ($p = \infty$)

It first starts with the simplest case, in which additional assumptions are

1. r is Constant (uniform).
2. Re-order point $s = 0$

The investigation can be based on two conditions: $p = \infty$ and $p < \infty$

Case 1: $p = \infty$ (Figure 4)

Clearly, this case needs only input variables: r , h (holding cost: \$/unit/period). The variable should be determined, which is the order quantity (Q). It is easy to prove the optimum order quantity as:

$$Q_o = \pm \sqrt{\frac{2Kr}{h}} \quad (\text{See Appendix 1})$$

Therefore, the answers for the two questions “how much to order” and “when to order” should be:

How much: $Q_o = \pm \sqrt{\frac{2Kr}{h}}$

When: $t_p = \frac{Q_o}{r}$

Where:

K = setup (or ordering) cost for placing an order Money/order

h = holding cost per unit inventory per unit time Money /unit/period

r = demand rate

In this case, the order quantity is usually referred to as Wilson’s economic lot size or simply the economic order quantity (EOQ), which is actually a classical EOQ model.

As said in Chapter 2, EOQ is well known and easy to understand and find insights for an inventory policy since it was introduced in 1913 by Ford W. Harris. There are many papers for this model. The objective of the EOQ model is simple, to find that particular quantity to order which minimizes the total variable costs of inventory. As seen, the total costs are usually computed on an annual basis and include two components, the costs of ordering and holding inventory. Annual ordering cost is the number of orders placed times the marginal or incremental cost incurred per order.

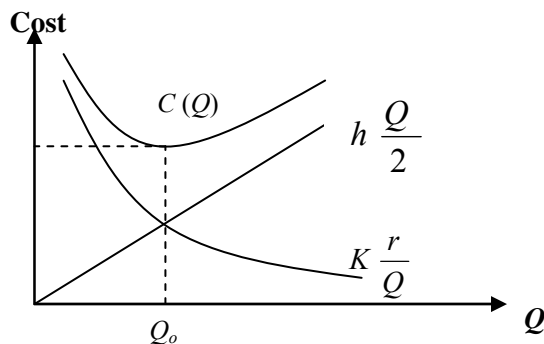

Figure 5. Cost curve in lot size system

(Taha, Operations Research, an Introduction, Macmillan Publishing Company, 5th)

By adding the item, holding and ordering costs together, the total cost curve is determined (Figure 5), which in turn is used to find the optimal inventory order point that minimizes total costs. Figure 5 illustrates how these two components (annual holding cost and annual order cost) change as Q , the quantity ordered, changes. As Q increases the holding cost increases but the order cost decreases. Hence the total annual cost curve is as shown below – somewhere on that curve lies a value of Q_o that corresponds to the minimum total cost. Thus, the optimal solution is easy to obtain. This basic EOQ model is based on the following assumptions that must hold before the model can be used, including:

1. Demand is constant.
2. Only relevant costs are holding and ordering/set-up.
3. Set-up costs are constant.
4. All demands for the product will be satisfied.
5. No quantity discounts.
6. No uncertainty in lead-time or supply.

Under these assumptions, it is true that EOQ is not especially sensitive to errors in inputs. But the realities include:

1. Uncertain demand
2. Variable order quantity
3. Lead-time > 0 , varies
4. Initial inventory > 0

For convenience, the researchers developed EOQ models in the case of the deterministic demand and relaxed some of the above assumptions when the basic EOQ model is used for the application. Among these developed models, to better model reality, relaxing the assumptions and using (s, S) policy as the next section will develop this basic EOQ

model. Taha has summarized these developed models (Taha, Operations Research, an Introduction, Macmillan Publishing Company, 5th & 6th Edition).

Single Stage Inventory Policy with Probabilistic Demand– Random Variable Demand

The single–stage inventory policy was analyzed and estimated with deterministic demand. However, it is rare that a deterministic static demand would occur in real life. Thus, this situation may be regarded as the simplest case. The most accurate representation of demand can perhaps be made by probabilistic non–stationary distribution. However, as we mentioned earlier, from the mathematical standpoint the resulting inventory system will be made complex by probabilistic non–stationary distribution. Normally, the deterministic demand distribution or stationary probabilistic demand distribution with some assumptions are selected.

In this section different single–stage inventory models with stationary probabilistic demand are presented. The first model extends the deterministic continuous review model (S system in the previous section) by directly including probabilistic demand in the formulation. The basic decision criterion used with the probabilistic inventory model in this section is the minimization of the expected cost as before. However, the objective is to concentrate on the development of the inventory problem, and consider the possibilities in the iron and steel–making field.

In this section a stochastic demand process will be considered, D , during the period. $f(D)$ is defined as the probability density function (PDF) of demand D for the continuous case, while $p(D)$ as the probability density function (PDF) of demand D for the discrete case. They can be expressed as:

$D \sim p(D)$ when $D = 0, 1u, 2u, 3u \dots$ discrete.

$D \sim f(D)$ when $0 \leq D \leq \infty \dots$ continuous.

Further, the expected cost for the period will be analysed and estimated.

For a continuous model, it assumes that the period is specified as t_p , let order rate p be ∞ (without ordering cost), the expected cost $C(S)$ (cost/unit time) for the period is then given by

$$C(S) = hI_1(S) + gI_2(S)$$

Where:

h = holding cost per unit inventory per unit time

Money /unit/period

g = shortage or emergency-order cost

Money / unit

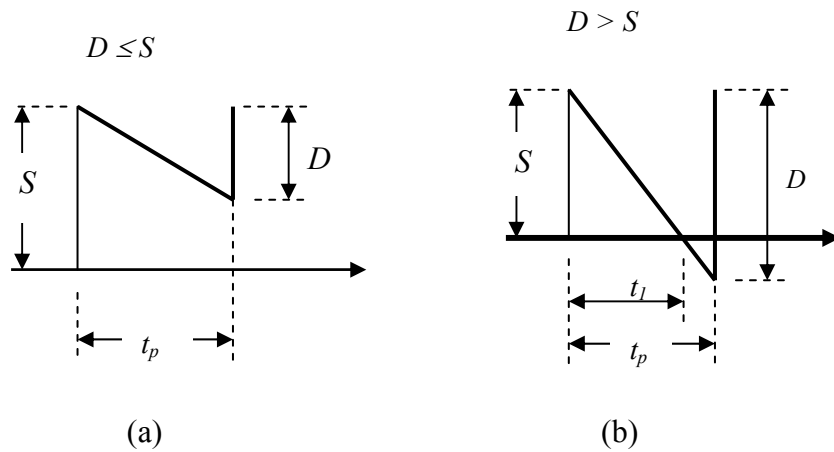

Figure 6. Probability density function (PDF) of demand for the continuous case (Taha, Operations Research, an Introduction, Macmillan Publishing Company, 5th Edition. p. 523)

From Figures 6 (a) and (b), given D , the holding inventory quantity and the shortage inventory quantity are given by two cases, as follows (Taha, Operations Research, an Introduction, Macmillan Publishing Company, 5th Edition. p. 523):

Case 1. $D \leq S$

$$I_1(S, D) = S - \frac{D}{2}$$

$$I_3(S, D) = 0$$

Case 2. $D > S$

$$I_1(S, D) = \frac{S t_1}{2 t_p} = \frac{S S}{2 D} = \frac{S^2}{2D}$$

$$I_3(S, D) = \frac{(D-S)t_2}{2t_p} = \frac{D-S}{2} \frac{D-S}{D} = \frac{(D-S)^2}{2D}$$

Thus, the holding inventory quantity and the shortage inventory quantity should be:

$$I_1 = \int_0^S \left(S - \frac{D}{2} \right) f(D) dD + \int_S^{\infty} \frac{S^2}{2D} f(D) dD$$

$$I_3 = \int_S^{\infty} \frac{(D-S)^2}{2D} f(D) dD$$

For a discrete model, the previous results can be expanded into the discrete case, thus the holding inventory quantity and the shortage inventory quantity should be:

$$I_1 = \sum_{D=0}^S \left(S - \frac{D}{2} \right) P(D) + \sum_{D=S+1}^{\infty} \frac{S^2}{2D} P(D)$$

$$I_3 = \sum_{D=S+1}^{\infty} \frac{(D-S)^2}{2D} P(D)$$

The Leibnitz Rule can be used to formulate the following equation (See Appendix 2)

$$\int_0^{S_0} f(D) dD + \int_{S_0}^{\infty} \frac{S_0}{D} f(D) dD = \frac{g}{(h+g)}$$

S_0 can be calculated from the above equations.

Because of the discrete case, let $D, S = 0, 1u, 2u \dots$ the expected cost $C(S)$ (cost/unit time) for the period is then given by:

$$C(S) = h \left[\sum_{D=0}^S \left(S - \frac{D}{2} \right) P(D) + \sum_{D=S+u}^{\infty} \frac{S^2}{2D} P(D) \right] + g \left[\sum_{D=S+u}^{\infty} \frac{(D-S)^2}{2D} P(D) \right]$$

$$C(S_o) \leq C(S_o + u)$$

$$C(S_o) \leq C(S_o - u)$$

Thus, $M(S_o - u) \leq \frac{g}{h + g} \leq M(S_o)$

Where:

$$M(S) = \sum_{D=0}^S P(D) + (S + \frac{u}{2}) \sum_{D=S+u}^{\infty} \frac{P(D)}{D}$$

h = holding cost per unit inventory per unit time

Money /unit/period

g = shortage or emergency–order cost

Money / unit

Analysis and Estimation of a Single–Stage Model-- (s, S) Policy

The single–stage inventory models occur when an item is ordered once only to satisfy the demand of a specific period. In this section single–stage models will be investigated under different conditions, including instantaneous demand with and without ordering cost. It is assumed that stock ordering occurs instantaneously. The optimal inventory level will be derived based on the minimization of the expected inventory cost, which includes ordering, holding, and shortage.

At Instantaneous Demand without Ordering Cost

For a continuous model (Figure 7), in the model with instantaneous demand, it is assumed that the total demand is filled at the beginning of the period. Thus, depending on the amount demanded, D , the inventory position right after demand may be either positive (surplus) or negative (shortage).

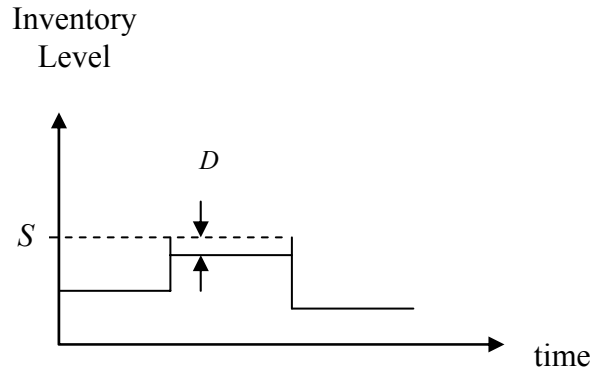

Figure 7. A continuous model with instantaneous demand

(Taha, Operations Research, an Introduction, Macmillan Publishing Company, 5th Edition. p. 519)

The two cases are shown in Figure 7. From Figure 7, the amount on hand after an order is received, the hold inventory I_1 , and the shortage inventory I_2 are generally in two cases, which are $D \leq S$ and $D > S$. Let D be the demand during t_p ,

$f(D)$ is defined as the probability density function (PDF) of demand D . Further, let c be the purchasing cost per unit. If it assumes that S is continuous and no setup cost is incurred, the expected cost for the period is then given by:

$$C(S) = h \int_{D=0}^{\infty} I_1 f(D) dD + g \int_{D=0}^{\infty} I_3 f(D) dD$$

Thus the hold inventory I_1 , and the shortage inventory I_2 are given by:

Case 1. $D \leq S$

$$I_1(S) = S - D$$

$$I_3(S) = 0$$

Case 2. $D > S$

$$I_1(S) = 0$$

$$I_3(S) = D - S$$

(Taha, Operations Research, an Introduction, Macmillan Publishing Company, 5th Edition. p. 519)

For the cost function should be:

$$C(S) = hI_1(S) + gI_3(S)$$

If both cases are considered together, the cost function is given by:

$$C(S) = h \int_{D=0}^S (S - D) f(D) dD + g \int_{D=S}^{\infty} (D - S) f(D) dD \quad (3-4)$$

The optimal value of S_o is obtained by equating the first derivative of $C(S)$

$$\int_{D=0}^{S_o} f(D) dD = \frac{g}{h + g} \quad (\text{See Appendix 3})$$

(Taha, Operations Research, an Introduction, Macmillan Publishing Company, 5th Edition. p. 524. Note: the purchasing cost in this research is not taken into account in the above model)

Where:

h = holding cost per unit inventory per unit time	Money /unit/period
g = shortage or emergency-order cost	Money / unit

For a discrete model, if demand is now supposed to occur in a discrete rather than in a continuous case, then

$$C(S) = h \sum_{D=0}^S (S - D)p(D) + g \sum_{D=S+1}^{\infty} (D - S)p(D) \quad (3-5)$$

In a discrete case, the necessary conditions for a minimum are give by:

$$C(S_o) \leq C(S_o + u) \rightarrow C(S_o + 1) - C(S_o) \geq 0 \quad (3-6)$$

And

$$C(S_o) \leq C(S_o - u) \rightarrow C(S_o - 1) - C(S_o) \geq 0 \quad (3-7)$$

Taha gives the results in the discrete as follows (Taha, Operations Research, an Introduction, Macmillan Publishing Company, 5th Edition. p. 522):

$$\text{For (3-6),} \quad \sum_{D=0}^{S_o} p(D) \geq \frac{g}{h+g}$$

$$\text{For (3-7),} \quad \sum_{D=0}^{S_o - u} p(D) \leq \frac{g}{h+g}$$

Thus, S_o must satisfy:

$$\sum_{D=0}^{S_o - u} p(D) \leq \frac{g}{h+g} \leq \sum_{D=0}^{S_o} p(D)$$

Where:

h = holding cost per unit inventory per unit time

Money /unit/period

g = shortage or emergency-order cost

Money / unit

At Instantaneous Demand with Ordering Cost

Based on the previous analysis, the (s, S) policy is now analysed and estimated, first considering the model in the last section with the exception that ordering cost $C_o = KI_3$ will be taken into account. Let $C_T(S)$ be the total expected cost of the system inclusive of the set-up cost. Thus:

$$C_T(S) = hI_1(S) + gI_2(S) + KI_3$$

The minimum value of $C_T(S)$ is shown in last section to occur at S_o , satisfying

$$\int_{D=0}^{S_o} f(D)dD = \frac{g}{h+g}$$

Since C_o is constant, the minimum value of $C_T(S)$ must also occur at S_o . The curves $C(S)$ and $C_T(S)$ are shown Figure 8 following (Taha, Operations Research, an Introduction, Macmillan Publishing Company, 5th Edition. p. 524). The new symbols s

and S are defined in the figure for use later in the analysis. The value of S is equal to S_o , and the value of s is determined by:

$$C(s) = C_T(S) = C_o + C(S) \quad \text{for } s < S$$

Or

$$C(s) = C_T(S) = KI_3 + C(S) \quad \text{for } s < S$$

Thus, the question now is, for given D , the amount on hand before the order is placed, how much should be ordered. This question is investigated in three conditions:

1. $D < s$
2. $s \leq D \leq S$
3. $D > S$

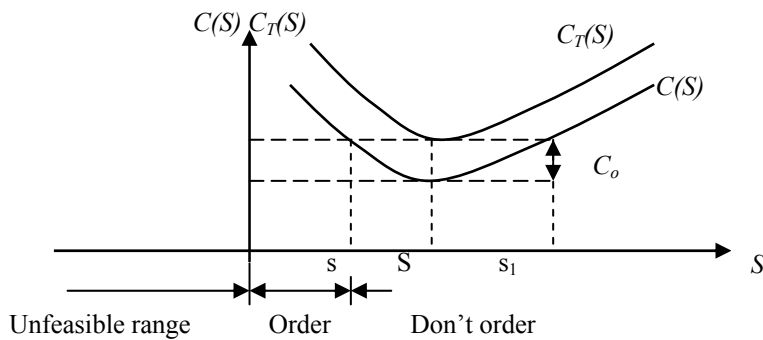

Figure 8. Curves $C(S)$ and $C_T(S)$ in discrete case

Case 1: $D < s$

In this case, its equivalent cost is given by $C_T(S)$ since x is already on hand. If any additional amount $S - D$ ($S > D$) is ordered, the corresponding cost given is $C_T(S)$, which includes the ordering K . It follows from Figure. 8, for all $D < s$,

$$\min_{S > D} C_T(S) = C_T(S) < C(D)$$

(Note: here S is different from S ; S is the amount ordered per cycle, while S is the order-up-to level)

Thus the optimal inventory level must reach $S_o = S$ and the amount ordered must be $S - D$.

Case 2: $s \leq D \leq S$

In this case, from Figure 8

$$C(D) \leq \min_{S > D} C_T(S) = C_T(S)$$

Thus it is no more costly not to order in this case. Hence $S_o = D$

Case 3: $D > S$

In this case, from Figure.8, for $S > D$

$$C(D) < C_T(S)$$

This again indicates that it is less costly not to order. Hence $S_o = D$.

This policy is called the (s, S) policy and it is summarized as follows:

If $D < s$, order $S - D$

If $D \geq s$, do not order

The optimality of the (s, S) policy follows from that the cost function is convex. In general, when this property is not satisfied, the (s, S) policy will cease to be optimal.

Up to now, the above models have been considered in this chapter, which deal with different single stage inventory situations, including different assumptions regarding the cost parameters, deterministic versus the probabilistic demand, and lead-times. The simplest model is associated with deterministic demands, while the more complex model is associated with probabilistic inventory situations.

In general, the (s, S) type policy is widely implemented in single-stage inventory systems. An (s, S) policy instructs that whenever the inventory position drops to or below s , the re-order level, an order is placed to raise it back up to S , the order-up-to level. When the demand process is given as a random variable, the stochastic model is referred to as the (s, S) model. Compared with the basic EOQ model, the (s, S) policy has considered, for example:

1. Lead-time: allow a lead-time between placing an order and receiving it – this introduces the problem of when to re-order (typically at some stock level called the re-order level). The (s, S) policy will input a re-order and lead-time.
2. Shortages or emergency-order: allow shortages, i.e. no stock currently available to meet orders. The (s, S) policy will put it in shortage costs.
3. Buffer (safety) stock (SS) – some stock is kept back to be used only when necessary to prevent shortages.

In evaluating any inventory models, including (s, S) policy and its developing models, generally two cost components are considered: ordering cost and holding-shortage cost. Optimization of an (s, S) system is to get a pair of s and S parameters so as to minimize the long-run average cost (per period) or discounted total cost.

Some assumptions are also needed for the (s, S) policy (system) as follows:

1. Demand for the product is stationary probabilistic throughout the period.
2. Lead-time (time from ordering to receipt) is constant (for the extended policy).
3. Price per unit of the product is constant.
4. Inventory holding cost is based on average inventory.
5. Ordering costs are constant.
6. All demands for the product will be satisfied.

Normally, the (s, S) policy is a good choice if both review and ordering costs are high. Thus, the (s, S) policy is widely implemented in single-stage inventory systems after the investigating and alternatives. In this case, the possible application of the (s, S) policy for iron and steel making is considered. However, some extension to its

assumptions should be made before it applies to real industry and it meets its service level.

Extension (s, S) Policy: with Lead-time, Buffer Stock and Service Operations

In this section with the (s, S) policy, more assumptions are relaxed. There are some extensions to the (s, S) policy considered – for example:

1. Lead-time: allowing a lead-time between placing an order and receiving it introduces the problem of when to re-order (typically at some stock level called the *re-order point, s*). The extension (s, S) policy will input a re-order lead-time.
2. Buffer (safety) stock: in most cases we would set the level of safety stock, namely the initial inventory level, so as to assure some specified service level. Some stock is kept back to be used only when necessary to prevent shortages.
3. Service level: probability that demand will not exceed supply during lead-time.

By adding the above items, it is hoped that a high level of customer service can be achieved. The definition $r\%$ is given as the service level, and σ is the standard deviation of the lead-time demand, while SS is the safety stock. As stated, SS is added and ordered earlier because of L to reach the desired customers. A parameter $r\%$ is needed to express the service level, $r\%$ is called the service level or fill rate according to subsection 3.2.1, which is the desired probability of not running out of stock in any one cycle. The strategically important $r\%$ is set by top management and is a strategic performance measure. In general, $r\%=99.8\%$, in the iron and steel industry, $r\%$ should be 100% for iron-making according to this definition, because the BF process needs uninterrupted feeding. This research will take the definition for $r\%$ in the next chapter so as to consider service level in the case study.

As discussed in the last section, the (s, S) policy determines when to order. When the inventory level on hand drops to a predetermined amount (s), it is time to re-order. In extension (s, S) policy, this amount should include expected demand during lead-time and usually some safety stock to reduce the probability of a shortage. Without buffer stock,

stock may run out of because of a re-supply delay or higher than anticipated demand. If demand can be predicted then normal EOQ orders are merely placed on time. But a shortage with unpredictable demand (demand fluctuations) is risked, so introducing a safety stock (*SS*) or buffer stock reduces the risks of variable demand/lead-time.

Here, lead-time and *SS* under (*s*, *S*) policy are discussed. Order quantity is fixed for a period of time t_p in order to maintain an inventory level (*S*), also called order-up-to level. The base inventory level *S* is determined by calculating the quantity needed between the time the order is placed and time that the next period's order is received and adding a quantity of safety stock to allow for variation in the demand.

The time between the placing of the order and the receiving of the next period's order is the sum of review period t_p and the replenishment lead-time L . The demand per unit of time, μ_d , is multiplied by the time between order placement and the next period's order ($t_p + L$) to determine the expected quantity to be sold. *SS* depends upon the variability in the demand and the desired order fill rate (customer service level).

Suppose D_{avg} is the average weekly demand in units and L is the lead-time (e.g. weeks). This basically means if an order is placed now, the order will arrive after L (weeks). Hence, the order must be L weeks in advance. Since the weekly demand is D_{avg} , the demand or consumption during these L weeks will be given by

$$DL = D_{avg} \times L \quad (3-8)$$

Thus, an order should be placed L weeks in advance or as soon as the inventory level drops to *s*, which is the re-order point. Therefore,

$$s = DL = D_{avg} \times L \quad (3-9)$$

s units are needed in the inventory to meet the demand during the lead-time of L weeks. Thus, DL can be called the lead-time demand. Enough inventories are at least needed to

cover the lead-time demand. Since the lead-time demand may vary, it is advisable to carry some extra inventories, SS (Safety Stock) on top of the lead-time demand so as to achieve high customer service; s is thus given by:

$$s = D_{avg} \times L + SS \quad (3-10)$$

For simplification in some cases, the general safety stock calculation is given by:

$$SS = (\text{Max. weekly demand} - \text{Average weekly demand}) \times L \quad (3-11)$$

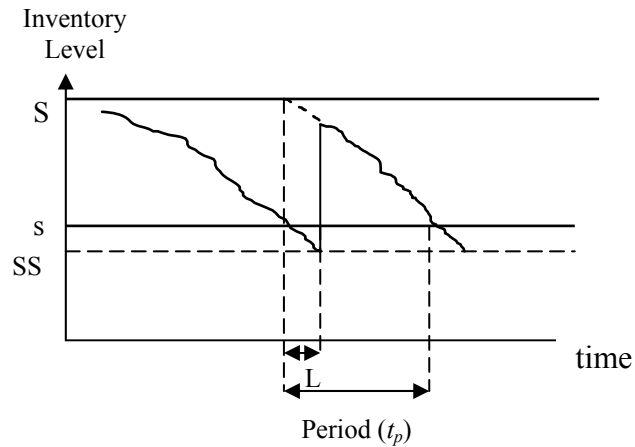

Figure 9. Extension (s, S) policy

(<http://www.business.auburn.edu/~gibsobj/2006%20-%20AMLG%205770/AMLG%205770%20-%20Chapter%2003.ppt>)

For the case study in the steel industry in this research, SS must take into account around 2–3 weeks of material feeding to the BF process, that is $SS = \text{Average weekly demand} \times 2.5 \text{ weeks}$.

Thus, the re-order point is a function of:

1. Lead-time
2. Average demand
3. Demand variability
4. Service level

Figure 9 shows a view of the extension (s, S) policy.

3.2.4 Shortening Lead-time by Inventory model

The different inventory models based on EOQ type models have been analysed in the previous section and it has also been shown that the extension (s, S) policy can provide one of the most suitable models for inventory management comparison with the basic EOQ model and its extension model. One of the features of extension (s, S) policy is the lead-time allowed that corresponds to the real world. On the other hand, re-order point s and safety stock SS will increase, and service level decrease due to the lead-time. Considering lead-time, the entire production process becomes asynchronous, with high lead-time variability and its consequences of rising safety stock needs. Therefore, improvements can be made in lead-time, which should shorten by employing several strategies in the company. Some issues about short lead-time will be discussed in this section.

The work by Zipkin (1986) and Karmarkar (1993) offers much insight on lead-time estimation using basic elements of congestion in the production environment. The setup cost in classical EOQ models is typically excluded from the lead-time model since it is not part of the basic trade-off. Karmarkar (1989) noted that WIP and lead-time related costs are significant parts of total manufacturing costs, even when capacity utilization is less than 100 percent. He suggested that lot-sizes are associated with lead-times and are quite different from those of conventional EOQ models (Karmarkar 1987).

Table 4. Lead-time segment (Murgiano 1994)

Lead-time	Greater Costs From
	Increased overhead
Set Up Time	Decreased machine utilization
	Decreased labor productivity
	Forcing increased queue time
	Lost opportunity cost of capital
Queue Time	Greater quality problems
	Obsolescence
	Greater space requirements
	Taxes
Move Time	Increased material handling

Suri (1998) developed Quick Response Manufacturing (QRM) strategy to shorten the lead-time, which is discussed in detail in the next sub-section. Murgiano (Waterloo Manufacturing Software, USA. <http://www.waterloo-software.com/leadtime.html>) has proposed that the best way to understand the relationship between short lead-times and low costs is to break lead-time up into its segments: set up time, process time, queue time, and move time (Table 4). During the process time segment of lead-time, a company is transforming components or raw material and bringing them closer to their final shippable state. Only during the process time segment is a company adding value. According to Murgiano's concept, if a manufacturer has inventory in-house and is not adding value to it, it is incurring cost.

From these views of different aspects in lead-time, it can be assumed that lead-time is a function of the following:

1. Manufacturing speed
2. Service level
3. Amount of inventory on hand

The previous sections have discussed that the traditional EOQ models do not care about responsiveness for their models and have fixed assumptions. Quick response manufacturing (QRM) developed by Suri (1998), a new model of manufacturing cycle-time reduction, is becoming a company-wide strategy to shorten lead-times in all phases of a manufacturing enterprise. It facilitates bringing products to market more quickly and secures business prospects by helping companies compete in a rapidly changing economic arena. QRM will not only make a firm more attractive to potential customers, it will also increase profitability by reducing non-value added time, cutting inventory level in inventory management and increasing return on investment. According to Suri (1998), QRM focuses all efforts towards a single goal – lead-time reduction. From the inventory management point of view, the relationship between lead-time and inventory level will be analysed.

According to Suri and his LT equation (See Appendix 4), the illustration is shown in Figure10. Figure10 (a) shows the behaviour that increasing variability in either arrival

times or job times will cause the lead-time to increase. For this case, at 70% utilization and low total variability, the lead-time might be low variability. Suri (1998) hence summarizes the issue with the QRM principle, planning to operate at 80% or even 70% capacity on critical resources. Figure 10 (b) shows the behaviour of lead-time as a function of lot size decision. Q_{MIN} is the lot size when U equals 1 (100%), while Q^* is the lot size when the lead-time is minimal. Obviously, if responsiveness (agileness) is the goal of the company, then order (lot size) policy should be to operate at a Q^* level on average.

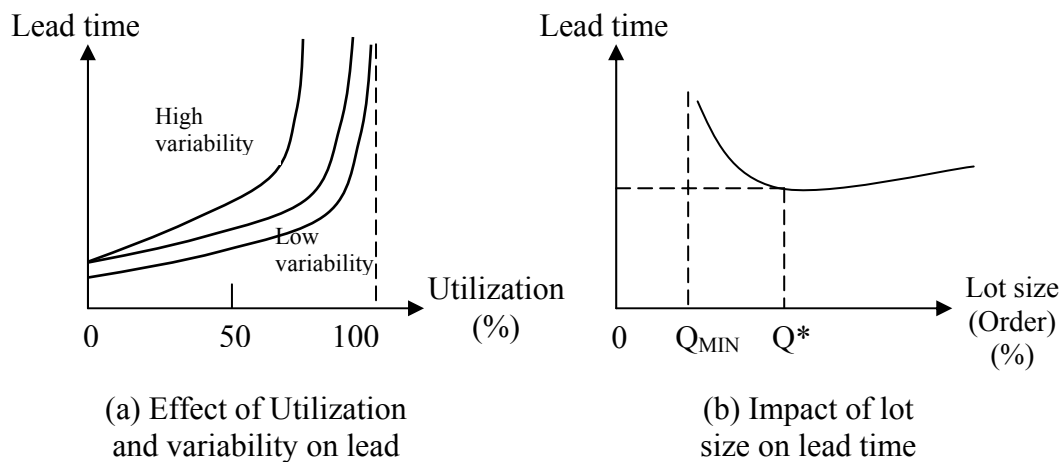

Figure 10. U and lot size with lead-time (Suri)

It is clear that QRM strategy takes different lead-times to satisfy customer demand by responsiveness. Compared with traditional EOQ models, as analysed in the previous sections, QRM strategy is widely considering more time formulae. EOQ models estimate the order quantity by optimising the cost function without estimating the dynamics and interactions of production. In the view of QRM, the EOQ model fails to consider several effects and costs when it operates its order policy. Suri summarized these, as follows:

1. Costs of long lead-times.
2. Market values of responsiveness.
3. Costs of a growing response time spiral.

4. Costs of poor quality.
5. Costs of obsolescence or engineering changes.

Concerning these effects, the pure EOQ models are inadequate today in practice, even if still widely used. An effective inventory management can not only run with smaller order quantity and lower inventories, but also with more rapid lead-times for improved customer response, like QRM.

Whatever actions and issues the company uses to shorten its lead-time, as Karmarkar states (in: *Handbooks in Operations Research and Management Science, Logistics of Production and Inventory* 4:6. 1993), the lead-time model provides a different way of thinking about bottlenecks. The traditional definition of a bottleneck is the resource with the highest utilization, since total throughput will be limited by that resource. This is a useful definition in situations where production efficiency, capacity utilization and throughput maximization are the key criteria. However, the recognition of lead-time as a measure of production performance suggests that a bottleneck might be alternatively defined as any resource that has a long delay associated with it. This same result has been also proved by QRM. Contrary to lead-time models, EOQ models do not shorten lead-time and few models consider lead-time, and just regard lead-time as a constant.

3.3 EOQ Models and Periodic Policy in the Development of Modern Industry

3.3.1 EOQ Models Falling into Disfavour in Modern Industry

The previous subsections have analysed and evaluated EOQ type models, whose simplest possible models have been added to with all kinds of restrictions. Even though its developed models have increased in complexity according to the real world, the EOQ model still has a number of limitations due to the assumptions that it is based upon, namely:

1. Constant demand.
2. Instantaneous delivery.
3. Single product.

4. Fixed set-up costs.
5. Ignoring quantity discounts.

Being aimed at the limitations of the EOQ model, a number of methods such as JIT, Total Quality Management (TQM), Theory of Constraints (TOC), Optimised Production Technology (OPT), Period Batch Control (PBC) and Material Requirements Planning (MRP) are being used by companies in managing their production and inventory. Among these, PBC, originally developed by Burbidge (1978, 1985, 1996) shows strong benefits for multiple stage production and inventory management.

For multi-stage production, PBC is a production planning system that has strongly been propagated as a simple and effective instrument in obtaining the benefits of Group Technology (GT), such as short throughput times and low work in progress. In order to obtain these benefits, PBC decomposes the manufacturing system in N stages and gives each stage the same amount of time P to complete the required operations. At the end of a period of length, P, the work is transferred to the next stage, and new work arrives from the preceding stage. Here, we do not focus on how to design PBC and how it works., but just list some benefits of PBC relative to EOQ shortcomings (Table 5).

Table 5. Comparison between EOQ and PBC

	EOQ	GT + PBC
Load of work on groups	Difficult to treat	Flexible to permit the addition of parts, requirements, stock orders, etc.
Setting-up time	Not a concern	Minimum setting-up time
Operation scheduling	Simple	Simpler
Ordering	Simple	Simpler
Throughput time	Not a concern	Short throughput time
Reaction to market demand	Stable demand, even stationary Probabilistic demand	Rapidly follows changes in market demand with minimum of stock and WIP
Accountability	Worse accountability in SDN	Better accountability (delegation)

Obviously, due to the number and diversity of factors that have to be considered, the historical EOQ in the modern supply network is losing its benefits and becoming a daunting task with complex demands from the customer. Periodic models in inventory systems are gaining increasing popularity as a way to quickly improve productivity and competitiveness, and hence there is much research devoted to the development of various issues. As the traditional inventory model developed has many drawbacks in terms of flexibility, many new techniques of inventory control have emerged to cope with the fluctuating market demand. The fuzzy model – knowledge based on fuzzy set theory applied to inventory management will be applied in this research, which will be discussed in more detail in further chapters.

3.3.2 Main Reasons for the EOQ Model Limitations in Modern Industry

Burbidge (1978) examined three reasons why the EOQ model is faulty, namely:

1. It uses an uneconomic method of batching.
2. It accepts set up cost as a fixed cost.
3. EOQ theory provides an improvident method for fixing the investment on stocks.

In detail, in multi-stage production, four factors are relevant to the EOQ problem, namely the order quantity, run quantity, set up quantity and transfer quantity. These four batch quantities should be independent parameters; however EOQ assumes and gives all four of them the same value. This results in uneconomic batching. The EOQ model treats set-up costs (ordering costs) as a fixed cost; in fact, it is not difficult to reduce this cost if effort is made. Moreover, as fixing the value of the run quantity has a major effect on the size of the investment, this results in EOQ theory providing an improvident method for regulating the investment on stock.

Overall, in view of shortening lead-time and flexibility to SDN (Supply Demand Network), EOQ is neither a lead-time model that can shorten lead-time, nor is it a PBC model that can be flexible with stock order and set-up time according to market demand in SDN. In short, according to Burbidge (*Production Flow Analysis for Planning Group Technology*. 1989. p.166) “EOQ is pseudo-scientific nonsense”.

4 COMBINING FUZZY LOGIC CONTROL AND (s, S) POLICY IN INVENTORY MANAGEMENT

4.1 Overview

From the last chapter, we see that one of the purposes of this research has been to explore the approach associated with the extension (s, S) policy based on the traditional inventory model and optimising controls for the case iron and steel case company. The context of the present work is to explore the approach associated with the FICM based on fuzzy set theory. This work took place in two phases: foundations of fuzzy set theory and a fuzzy model in an inventory control system based on fuzzy set theory combined with the (s, S) policy.

4.2 Foundations of Fuzzy Set Theory

Traditional control systems are based on mathematical models. They are the products of decades of development and theoretical analysis, and are highly effective.

However, in many cases, a mathematical model of the control process may not exist, or may be imprecise, including the traditional inventory model because of too much simplifying, or be too “expensive” in terms of computer processing power and memory, and a system based on empirical rules may be more effective. If the traditional control systems are so well-developed, why bother with fuzzy control? It has some advantages, such systems can be easily upgraded by adding new rules to improve performance or add new features, and so on.

Fuzzy set theory has been studied extensively over the past 40 years. Most of the early interest in fuzzy set theory pertained to representing uncertainty in human cognitive processes. The use of fuzzy set theory as a methodology for modelling and analyzing decision systems is of particular interest to researchers in real world management due to the ability of fuzzy set theory to quantitatively and qualitatively model problems which

involve vagueness and imprecision. Fuzzy set theory has been applied to problems in inventory management and production plan selection in some topical fields. Hence, fuzzy set theory can be one choice of raw materials inventory in the iron and steel case company.

In order to gain a better understanding of the use of fuzzy set theory in the case study and to provide a basis for this research, the foundations of fuzzy set theory are discussed in this section. These basic concepts and techniques will underlie fuzzy logic and its applications in both supply chain inventory control and management.

The concept of Fuzzy Logic (FL) was conceived by Zadeh, a professor at the University of California at Berkley, and presented not as a control methodology, but as a way of processing data by allowing partial set membership rather than crisp set membership or non-membership. This approach to set theory was not applied to control systems until the 70's due to insufficient small-computer capability prior to that time. Professor Zadeh reasoned that people do not require precise, numerical information input, and yet they are capable of highly adaptive control. If feedback controllers could be programmed to accept noisy, imprecise input, they would be much more effective and perhaps easier to implement. As Zadeh states (1965), as complexity rises, precise statements lose meaning and meaningful statements lose precision.

FL is a control system methodology that lends itself to implementation in systems ranging from simple, small, embedded micro-controllers to large, networked, multi-channel PC or workstation-based data acquisition and control systems. It can be implemented in hardware, software, or a combination of both. FL provides a simple way to arrive at a definite conclusion based upon vague, ambiguous, imprecise, noisy, or missing input information. FL's approach to control problems mimics how a person would make decisions, only much faster. After Zadeh presented the fuzzy set theory, a number of publications have been further contributing to this theory and fuzzy logic method. Among them, Zimmermann (1985) summarized and introduced the basic theory of fuzzy sets and its application in some areas.

The following sections will give an introduction to some of the basic concepts of FL.

4.2.1 Fuzzy Sets

Fuzzy logic starts with the concept of a fuzzy set. Fuzzy sets are an extension of classical (crisp) set theory and are used in fuzzy logic. In classical set theory the membership of elements in relation to a set is assessed in binary terms according to a crisp condition – an element either belongs to or does not belong to the set. By contrast, fuzzy set theory permits the gradual assessment of the membership of elements in relation to a set; this is described with the aid of a membership function.

A fuzzy set on a classical set X is defined as follows:

If X is a collection of objects denoted generically by x , then a fuzzy set \tilde{A} in X is a set of ordered pairs:

$$\tilde{A} = \{(x, \mu_{\tilde{A}}(x)) \mid x \in X\}$$

(Zimmermann, Fuzzy Set Theory, and its Application, 1985. p.11–12)

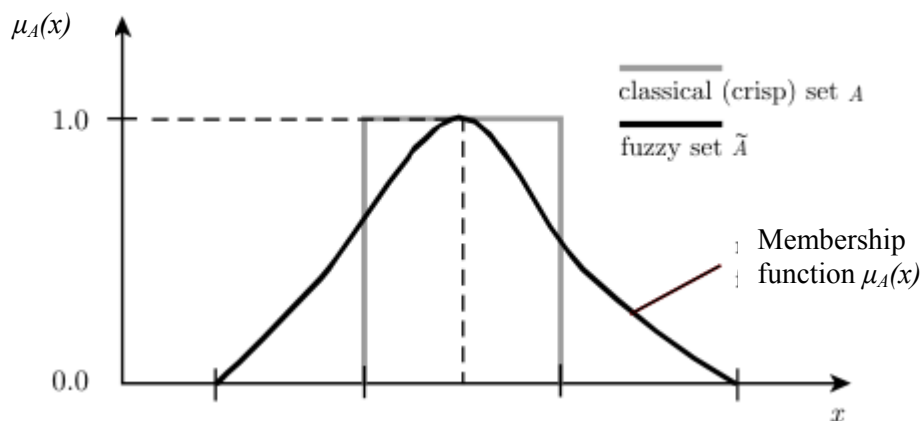

Figure 11. Fuzzy set and crisp set

$\mu_A(x)$ (Figure 11) is called the membership function that quantifies the degree of membership of the elements x to the fundamental set X . An element mapping to the value 0 means that the member is not included in the given set, 1 describes a fully included member. The range of the membership function is a subset of the nonnegative real numbers. The values strictly between 0 and 1 characterize the fuzzy members.

In fuzzy logic, the truth of any statement becomes a matter of degree. Any statement can be fuzzy. Fuzzy reasoning is the ability to reply to a yes–no question with a not–quite–yes–or–no answer. Reasoning in fuzzy logic is just a matter of generalizing the familiar yes–no (Boolean) logic. If it gives “true” the numerical value of 1 and “false” the numerical value of 0, fuzzy logic also permits in–between values like 0.1 and 0.5.

4.2.2 Membership Functions

The membership function is a graphical representation of the magnitude of participation of each input, which needs to be mathematically and numerically well defined with proper and various methods based on their various applied areas and relevance parameters. It associates a weighting with each of the inputs that are processed, defines functional overlap between inputs, and ultimately determines an output response. The rules use the input membership values as weighting factors to determine their influence on the fuzzy output sets of the final output conclusion.

There are different membership functions associated with each input and output response. The simplest membership functions are formed using straight lines. Of these, the triangular (Figure 12) is common, but bell, trapezoidal, haversine and exponential have been used. More complex functions are possible but require greater computing overhead to implement. Some features of the membership function are: magnitude (usually normalized to 1), width (of the base of function), shouldering (locks height at maximum if an outer function. Shouldered functions evaluate as 1.0 past their centre), centre points (centre of the member function shape), overlap (N&Z, Z&P, typically about 50% of width but can be less). For a detailed description, one example shown in Figure12 illustrates the features of the triangular membership function, which is used in

the normal case application because of its mathematical simplicity. Other shapes can be used, but the triangular shape lends itself to this illustration. The degree of membership (DOM) is determined by plugging the selected input parameter (error or error-dot) into the horizontal axis and projecting vertically to the upper boundary of the membership function(s).

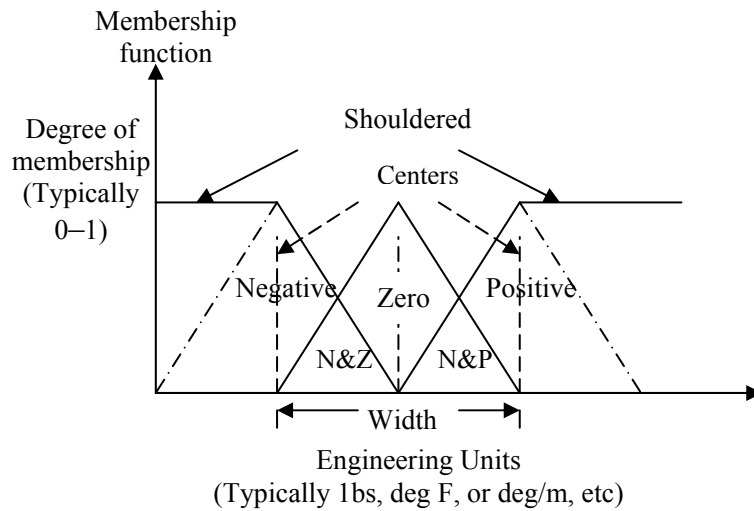

Figure 12. Features of the triangular membership function
 (Kaehler, Fuzzy Logic Tutorial, *Encoder, The Newsletter of Seattle Robotics Society*)

In brief, there is a unique membership function associated with each input parameter. The membership functions associate a weighting factor with values of each input and the effective rules. By computing the logical product of the membership weights for each active rule, a set of fuzzy output response magnitudes are produced. In short, a membership function associated with a given fuzzy set maps an input value to its appropriate membership value

4.2.3 Fuzzy Logical Operations

Classical set theory uses Boolean logic that provides the fundamental operator on sets, including the union (or), intersection (and) and not operators. These operators also exist in fuzzy logic, but are defined differently. Zadeh (1965) presented these general terms as follows:

The membership function $\mu_C(x)$ of the intersection $C=A \cap B$ is given by:

$$\mu_C(x) = \text{MIN} \{ \mu_A(x), \mu_B(x) \}, x \in X$$

The membership function $\mu_D(x)$ of the union $D=A \cup B$ is given by:

$$\mu_D(x) = \text{MAX} \{ \mu_A(x), \mu_B(x) \}, x \in X$$

The membership function $\mu_{\hat{A}}(x)$ of the complement of a normalized fuzzy set \hat{A} ; $\mu_{\hat{A}}(x)$ is given by:

$$\mu_{\hat{A}}(x) = 1 - \mu_A(x), x \in X$$

Besides the above general operators, Zadeh and other authors have extended the terms; Zimmermann (1985) has discussed these extensions. This research will only concern itself with the general terms.

4.2.4 Fuzzy Rules

Fuzzy set theory offers the possibility of application for handling vague or uncertain information. Fuzzy logic is one application of fuzzy set theory; as Zadeh (1973) says, it is an extension of set-theoretic multi-valued logic, in which the truth values are linguistic variables (or terms of the linguistics variable truth). Zadeh (1975) also presented a logic whose distinguishing feature are (i) fuzzy truth-values expressed in linguistic terms, e.g., true, very true more or less true, rather true, not true, false, not

very true and not very false, etc. (ii) imprecise truth tables; and (iii) rules of inference, whose validity is approximate rather than exact.

When fuzzy sets and fuzzy operators are applied in fuzzy logic, the fuzzy rules (if-then rule statements) are used to formulate the conditional statements that comprise the fuzzy logic, and it can help to simplify implementation by combining multiple inputs into single if-then statements while still handling non-linearity. A single fuzzy if-then rule assumes the form if x is A then y is B , where A and B are linguistic values defined by fuzzy sets on the ranges (universes of discourse) X and Y , respectively. The if-part of the rule “ x is A ” is called the antecedent or premise, while the then-part of the rule “ y is B ” is called the consequent or conclusion (MatLAB 6.5, Fuzzy logic toolbox help).

For example, in inventory control, dealing with inventory control in terms such as “if” demand is too high, “and” inventory is getting low, “then” add order to the inventory is used. These terms are imprecise and yet very descriptive of what must actually happen.

It is obvious that FL can handle imprecise inputs, is inherently robust, and can process any reasonable number of inputs, but the system complexity increases rapidly with more inputs and outputs. Simple if-then rules are used to describe the desired system response in terms of linguistic variables rather than mathematical formulae in a non-linear system. The number of rules is dependent on the number of inputs, outputs, and the designer’s control response goals.

Interpreting an if-then rule involves distinct parts, as follows (MatLAB 6.5, Fuzzy logic toolbox help)

1. Fuzzify inputs: Resolve all fuzzy statements in the antecedent to a degree of membership between 0 and 1. If there is only one part to the antecedent, this is the degree of support for the rule.
2. Apply fuzzy operator to multiple part antecedents: if there are multiple parts to the antecedent, apply fuzzy logic operators and resolve the antecedent to a single number between 0 and 1. This is the degree of support for the rule.

3. Apply implication method: use the degree of support for the entire rule to shape the output fuzzy set. The consequent of a fuzzy rule assigns an entire fuzzy set to the output. This fuzzy set is represented by a membership function that is chosen to indicate the qualities of the consequent. If the antecedent is only partially true, (i.e., is assigned a value less than 1), then the output fuzzy set is truncated according to the implication method.

The case study sections will describe clearly that the linguistic variables are used to represent an FL system's operating parameters. In short, the fuzzy rules are a simple graphical tool for mapping the FL control system rules. They accommodate two input variables and express their logical operation as one output response variable. To use, define the system using if-then rules based upon the inputs, decide appropriate output response conclusions, and load these into the fuzzy rules.

4.2.5 Defuzzification

Defuzzification is the process of producing a quantifiable result in fuzzy logic. Typically, a fuzzy system will have a number of rules that transform a number of variables into a “fuzzy” result, that is, the result is described in terms of membership in fuzzy sets. (<http://en.wikipedia.org/wiki/Defuzzification>).

The most popular defuzzification method is centroid calculation, which returns the centre of area under the curve. In Matlab 6.5, there are five built-in methods supported: centroid, bisector, middle of maximum (the average of the maximum value of the output set), largest of maximum, and smallest of maximum (MatLAB 6.5, Fuzzy logic toolbox help).

4.2.6 Fuzzy Inference Systems

Fuzzy inference is the process of formulating the mapping from a given input to an output using fuzzy logic. The mapping then provides a basis from which decisions can be made, or patterns discerned (MatLAB 6.5, Fuzzy logic toolbox help). The process of

fuzzy inference involves all of the pieces that are described in the previous sections: membership functions, fuzzy logic operators, and if–then rules.

There are two types of fuzzy inference system that can be implemented in the Fuzzy Logic Toolbox: Mamdani (1975) type and Sugeno (1985) type. Mamdani's fuzzy inference method is the most commonly seen fuzzy methodology. It was proposed in 1975 by Mamdani as an attempt to control a steam engine and boiler combination by synthesizing a set of linguistic control rules obtained from experienced human operators. Sugeno–type systems extend Mamdani–type systems, the fuzzy part is still in the antecedent of rules, which are used for selection, the consequent of rules is more complex: some function (e.g. polynomial) of input variables. In general, Sugeno–type systems can be used to model any inference system in which the output membership functions are either linear or constant (MatLAB 6.5, Fuzzy logic toolbox help). References to descriptions of these two types of fuzzy inference systems can be found in the bibliography (Zimmermann 1985; Mamdani 1975; Sugeno 1985).

In summary, FL was conceived as a better method for sorting and handling data, but has proven to be an excellent choice for many control system applications, since it mimics human control logic. It can be built into anything, from small, hand–held products to large computerized process control systems. It uses an imprecise, but very descriptive language to deal with input data more like a human operator. It is very robust and forgiving of the operator and data input and often works when first implemented, with little or no tuning. It has been successfully applied in fields such as automatic control, data classification, decision analysis, expert systems, and computer vision. Due to its successful application, FL is possible to be associated with raw materials inventory control in the iron and steel case company, as a FICM.

4.3 Proposed FICM

In Chapter 2, the literature review illustrates how the fuzzy set theory has been applied to problems in inventory management and production plan selection in some fields.

Following the Fuzzy Logic (FL) based on the fuzzy set theory, the proposed model is using a fuzzy logic controller into account for the inventory control system based on fuzzy set theory in the iron and steel case company. Hopefully, it will reflect a significant shift in the application of modern fuzzy logic in the traditional iron and steel industry — a shift which will be of benefit to the case company and even to other iron and steel companies who hope to improve both control and management by FL techniques.

The quantitatively and qualitatively inventory control model problems involve the vagueness and imprecision, the classical (crisp) set theory is difficult to provide the appropriate model to the vagueness and imprecision. Since a fuzzy set is different from the classical crisp set, it is a mapping of a set of real numbers onto membership values lie in the range $[0, 1]$ by the membership functions and they are recognized as an important problem modelling and solution technique, this provides the possibility of using the FL based on the fuzzy set theory in modelling and simulation of supply chain inventory management.

The fuzzy control system design is based on empirical methods, basically a methodical approach to trial-and-error. Based on the previous sections about the basic concepts and techniques of FL, and some examples and case studies in some other industrial fields, the application procedures are summarized by Kaehler as follows (<http://www.seattlerobotics.org/encoder/mar98/fuz/flindex.html>):

- (1) Define the control objectives and criteria: What are we trying to control? What do we have to do to control the system? What kind of response do we need?
- (2) Determine the input and output relationships and choose a minimum number of variables for input to the FL engine (typically error).
- (3) Using the fuzzy rule-based structure of FL, break the control problem down into a series of IF X AND Y THEN Z rules that define the desired system output response for

given system input conditions. The number and complexity of rules depends on the number of input parameters that are to be processed and the number of fuzzy variables associated with each parameter. If possible, use at least one variable and its time derivative. Although it is possible to use a single, instantaneous error parameter without knowing its rate of change, this cripples the system's ability to minimize overshoot for step inputs.

(4) Create FL membership functions that define the meaning (values) of Input/Output terms used in the rules.

(5) Create the necessary pre- and post-processing FL routines when programming the rules into the FL engine (tool).

(6) Test the system, evaluate the results, tune the rules and membership functions, and retest until satisfactory results are obtained.

With the above train of thought, this research on modelling and simulation of raw material inventory by fuzzy logic techniques refers to the procedures associated with the classical model and the present situation in the case company. As a result, an improvement model of the inventory control model has been developed for the supply chain based on FL, which should be a fuzzy logic control combined with the (s, S) policy for the iron and steel company. With this model, several aspects of the system are handled in the same manner as in the crisp runs. This supply chain inventory model uses the benefits from the (s, S) policy that is applied to probabilistic inventory situations, as well as the benefits from modern fuzzy control theory that is very robust and forgiving of operator and data input, etc. Answering the two questions of an inventory policy (How much to order? And when to order?), with the proposed FICM, **the (s, S) policy will decide when an order needs to be placed, and the fuzzy controller will evaluate the order quantity when an order is being placed.**

In detail:

Firstly, the (s, S) policy will be used for when an order should be placed. The lead-time is taken into account with inventory level, which means that the forecast inventory involves order quantity from lead-time early.

$$\begin{cases} \text{forecast} - \text{inventory} < s(\text{crisp}), \text{ order } (Q_i \neq 0) \\ \text{forecast} - \text{inventory} \geq s(\text{crisp}), \text{ don't order } (Q_i = 0) \end{cases}$$

Then the fuzzy controller is used for how much an order quantity (Q_i) should be. In the application procedures mentioned earlier, the control objectives and criteria are first defined, thus the order quantity could be controlled so that the inventory level is up to S (the order-up-to level). Next, the input and output is determined; it is clear that the inventory level and the current period's demand quantity are the inputs, while the order quantity should be the output of the control system. When the inventory level on hand drops to a predetermined amount (s) –the re-order point that can be calculated by the extension (s, S) policy, an order will be placed, which will arrive after some weeks of delay (lead-time) from now (i -th period). The order quantity will be the function of the current inventory and demand, the FICM is given by:

$$Q_i = f(S_i, D_i) \quad \text{found by Matlab/Fuzzy Logic Toolbox} \quad (4-1)$$

Where

S_i = Current inventory level

D_i = Current demand quantity

Q_i = Order quantity

The current inventory level and the current period's demand are given membership function values. The membership values are based on a logic described later. To maintain flexibility in the model, all the parameters indicated below are in terms of the model's inputs. This allows the model to be adapted to different cases. The core advantages of a fuzzy controller are robustness under uncertainty and expert

experiments, and inaccurate information is considered. Then other procedures are followed.

Fuzzification: Input/Output is classified including the demand, inventory level and order into three sorts: low, medium and high. The corresponding membership function is similar to Figure 12 in the previous section. To implement a fuzzy controller, three elements are required: a collection of fuzzy control rules, an inference mechanism, and an output interface (defuzzification).

1. Fuzzy Control Rules: the fuzzy control rules are based on the experiences of inventory ordering policy. The relationship between demand, inventory level, and the order quantity is summarized in some tables, e.g. Tables 6 and 7: if demand is low (e.g. below average) and the inventory is low, then the order quantity is low (or medium); if demand is medium (e.g. average) and the inventory is medium, then the order quantity is high; if demand is high (e.g. above average) and the inventory is high, then the order quantity is high, and so on. The two input linguistic variables, demand and inventory, and one output linguistic variable, order quantity, are defined with the corresponding term sets {below /around average, as around average, above /around average}, {low, medium, high}, and {small, medium, large}, respectively.

In the case company of this research, for the demand, inventory level and order, each universe of discourse is assumed within U_d , U_i , and U_o . They can be expressed by:

$$U_d \in (0, X_d), U_i \in (SS, X_i), U_o \in (0, X_o)$$

For the inputs, the lower boundary of demand is zero, and the lower boundary of inventory level is SS , respectively. This makes sense, since it means no nought–demand has occurred, and the minimum inventory level has been the safety stock. Negative values of the demand and inventory are impossible in the case, and SS can be calculated by equation (5–9) in Chapter 5. For the output, the lower boundary of inventory equals zero, since there are no orders in the beginning. On the other hand, the upper limits of

the universes are set for the demand, inventory level and order as X_d , X_i , and X_o , respectively.

Where there is a one-stage fuzzy controller,

$X_d = 2 \times$ Average weekly demand

$X_i =$ Re-order point

$X_o = 2 \times$ Average ordering (purchasing) quantity

The values on the x-axis represent the different values for different variables. The scalar factor could be changed easily. Varying the value of this scaling unit can tune the membership function to make the performance better.

In the case study in the following chapter, it is possible to choose the shape of the membership function from a pool of commonly used parameterized families including triangular, trapezoidal, Gaussian, sigmoid, and S-shaped. After a shape is selected, the parameters are manipulated to tune the shape. The shape of triangular and trapezoidal was chosen as the shape of the membership function for inputs and output respectively. Some of them are shown as Figure 13. In the case study, with the aid of the Fuzzy Logic Toolbox in Matlab, it is possible to produce the membership of almost any imprecise concept.

Table 6. Relations1 between demands, inventory level and order quantity

<i>Inventory</i>	<i>Demand</i>			
	<i>Low</i>	<i>Medium</i>	<i>High</i>	<i>Zero</i>
Low	Low	Medium	High	Zero
Medium	Low	Medium	High	Zero
High	Low	Low	Medium	Zero

Table 7. Relations2 between demands, inventory level and order quantity

<i>Inventory</i>	<i>Demand</i>			
	<i>Low</i>	<i>Medium</i>	<i>High</i>	<i>Zero</i>
Low	High	High	High	Zero
Medium	Medium	High	High	Zero
High	Low	Low	High	Zero

Fuzzy Control Rules: the fuzzy control rules are based on the experiences of inventory ordering policy. The relationship between demand, inventory level and the amount to be ordered is summarized in Tables 6 and 7, etc. For example, the actual meaning of Table 6 should be that if demand is below around average, and the inventory is low, then the order quantity is low; if demand is average and the inventory is medium, then the order quantity is high; if demand is above average and the inventory is high, then the order quantity is high, and so on. Table 7 is a little more extreme compared with Table 6. It seems that higher order quantities are better in some demand cases, so that different fuzzy rules are used in the tables. It means less frequent ordering, so that it gives a better performance, since the ordering costs for placing an order are high when the holding costs are relatively low. Moreover, if demand is zero, then the order quantity is zero whatever the inventory is, and it will produce more cost-effectiveness for inventory with fuzzy logic control.

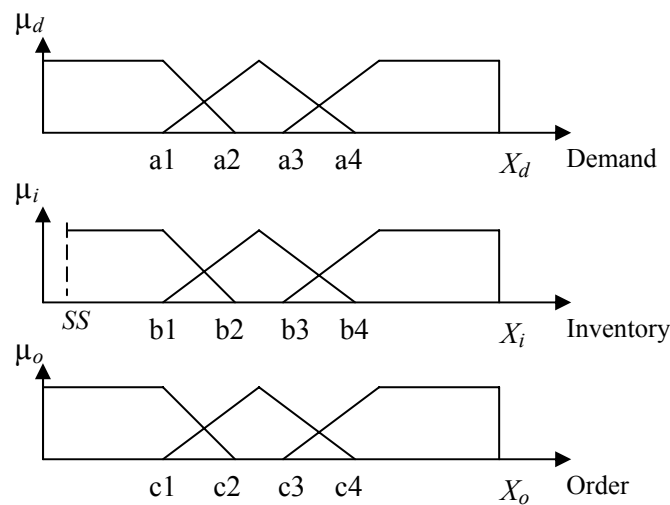

Figure 13. Fuzzy membership functions for demand, inventory and order

2. Membership Function: the values on the x-axis represent the different values for different variables. The scalar factor could be changed easily. Varying the value of this scaling can be tuning the membership function to make the performance better. For example, the demand as antecedent 1 has three terms, i.e. Low (L),

Medium (M) and High (H); the inventory level as antecedent 2 also has three terms, which are the same as the demand; and the order as consequent (the output) is also divided into three terms, the same as the inputs. Hence, the corresponding membership functions (MF) are established as a numerical meaning for each term. Several trial runs were used with fine-tune order quantity, and inventory level parameters.

3. Fuzzy Operators: complex operators drastically increase the number of computations necessary to run the system. So the minimum operations were selected as the intersection operators for ordering in the fuzzy model. Simply, the MIN operator performs the logical AND.

Inference Mechanism: Mamdani's fuzzy inference is performed in the output model, since this method is the most commonly seen fuzzy methodology. Also it is the default in the Fuzzy Logic Toolbox, which will be used in the case study. Thus, Mamdani's fuzzy inference is better suited for the case study.

Defuzzification: The most popular defuzzification method is centroid calculation, which returns the centroid of the area under the curve. There are five built-in methods supported: centroid, bisector, middle of maximum (the average of the maximum value of the output set), largest of maximum, and smallest of maximum. The centroid method is used for the case study.

Finally, this research should test the system, evaluate the results and tune the rules and membership functions, and retest until satisfactory results are obtained. Matlab-Fuzzy Logic Toolbox can help to simulate and analyse the system's performance by comparing the classical inventory model with fuzzy logical control combined with classical (s, S) policy.

4.4 Application of FICM to Counteract Demand Fluctuations

The proposed FICM which has been discussed combines the (s, S) policy and fuzzy logic controller. Whichever inventory model is used in a company, customer demand must act as a key input in inventory management. Especially demand fluctuations due to the bullwhip effect within a supply chain network have been highlighted by a number of researchers with reference to supply chain networks.

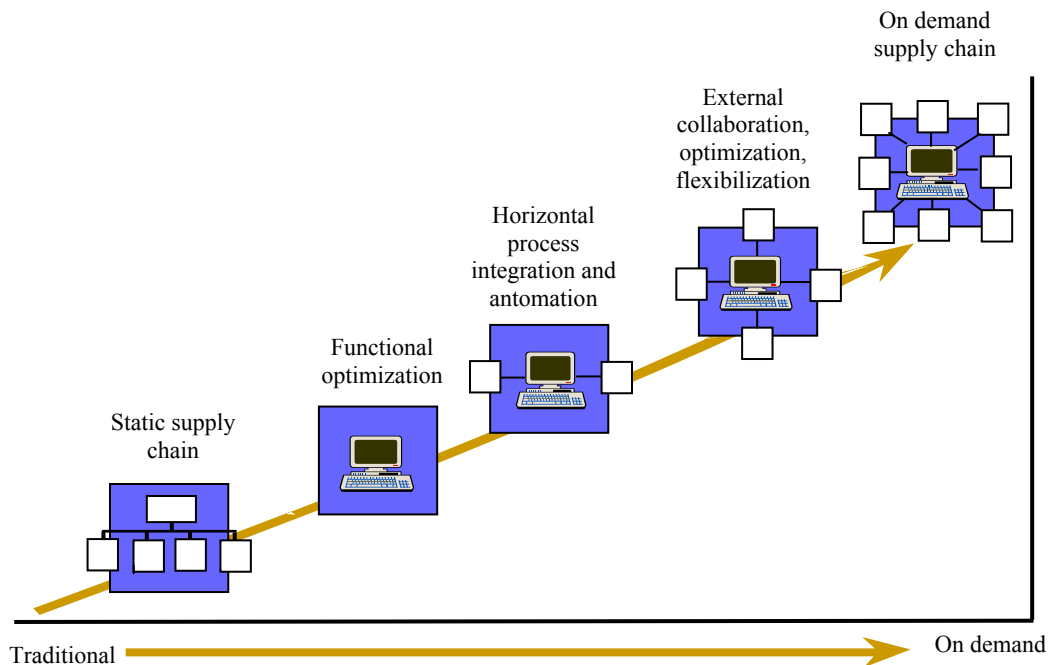

Figure 14. Supply chain maturity model: the path toward on demand (IBM Institute for Business Value 2003)

A recent trend of most companies is the need to establish effective and proactive real-time responses to evolving market conditions, customer expectations and daily supply and demand shifts. One of the recent important changes affecting the performance and management of supply chains is the increased visibility of downstream demand. This needs greater responsiveness within an own enterprise. The pressures to implement demand-driven supply-demand network practices and the reduction of the related costs

allowed by easier and cheaper access to communication and information technology resources make it possible for companies to begin to organize their interfaces, leading to a perspective shift from enterprises to extraprises. Overall, the traditional supply chain has recently shifted to demand-driven supply-demand network (SDN) (Figure 14). Therefore, a number of studies have shown increasing interests in coordination contract (Cachon & Lariviere 2001) with information sharing strategies (Lee et al. 2000) with SDN; integration studies have also gone beyond intra-organization control and internal integration, and more attention is being paid to the complicated external integrations problems across organizations (Frohlich & Westbrook 2001).

Considering the inventory management within SDN, and the demand from customers being the most important input of inventory control system, greater emphasis is being placed on the demand side in the inventory system of the network, on customer operations and fulfilling customer needs. Therefore, from the view of customer demand-driven SDN, it is necessary to investigate the demand and its fluctuations in inventory management through SDN so that the company can solve problems due to uncertain demand and its fluctuations. In terms of the feature of FL, the fuzzy logic controller can be used (1) for very complex processes, when there is no simple mathematical model. (2) for highly nonlinear processes. (3) if the processing of (linguistically formulated) expert knowledge is to be performed. Based on these commendable and applicable features, this research explores how the FICM works when the fluctuations happens to the demand. As the major previous objective of this model was to be cost-effective, the model's benefits in terms of order quantity and inventory cost have been discussed, so this section will only set out to explore the benefits of counteracting demand fluctuations with the proposed FICM, and the objectives are to investigate how the FICM counteracts demand fluctuations. The supply chain in the case company has been developed in recent years, and there are two types of participants in the demands – the company's own inner steel-making and the customers of the iron and steel markets. The demand from the inner steel-making mill may be stable or uniform, but the real market (iron and steel) demand is not stable due to the fluctuating steel and iron markets, which is a stochastic demand case or demand

with imprecise fluctuation case. The case study in this research aims at how the proposed FICM counteracts demand fluctuations under the current data given by SLC.

4.4.1 Demand Fluctuations and Causes

As one of the inputs of inventory management in SDN, customer demand plays a key role in achieving all the goals of effective inventory that have been presented in Section 1.2.2 and Chapter 3. As said earlier, most companies used to “measure their muscle” by their inventory level. The inventory level holding must provide the demand required by the inventory management system or the suggested storages to the best of the inventory’s ability. Figure 15 shows a clear picture description of the bullwhip effect, where slight discrepancies between channel demand and real demand can cause ever-larger ripples as they travel back through the supply chain – a powerful case for creating a more flexible and accurate supply chain, e.g. economic information sharing.

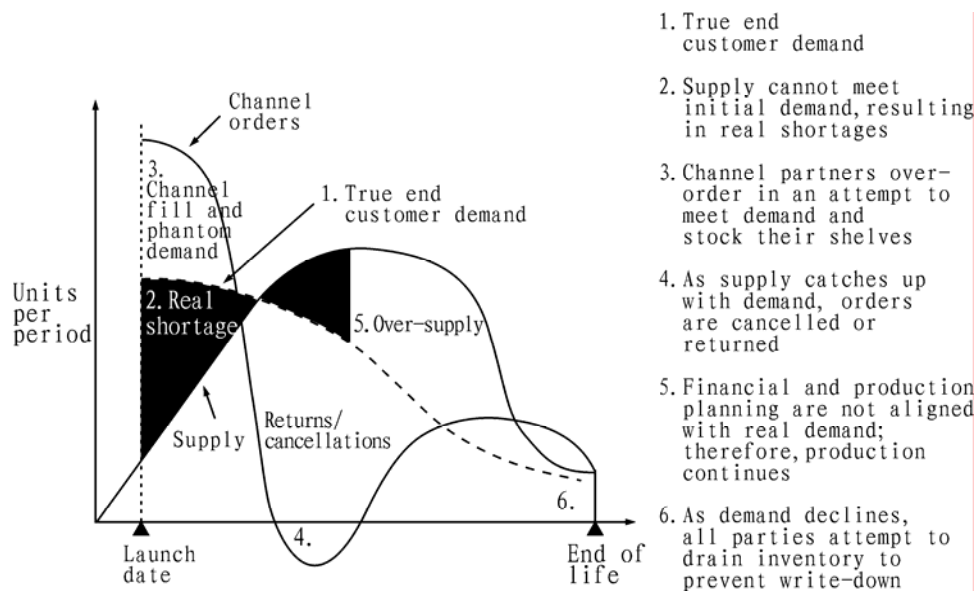

Figure 15. The bullwhip effect (Accenture)

With traditional inventory management, when a peak demand fluctuations occur the company has to keep a high inventory level to satisfy demand, even though this peak does not map true demand. Lee et al. (1997a) also gave an example of such fluctuations

in demand by the bullwhip effect, as shown in Figure 16. This maps the typical demand fluctuations by the bullwhip effect in SDN. In SDN, this kind of fluctuation occurs much more than in the traditional supply chain. On the other hand, because the most important goal of effective inventory management is reducing inventory and its cost, in view of the demand fluctuations in SDN companies should not only focus on minimum inventory level and cost by traditional inventory management systems, but also should care about demand fluctuations by the bullwhip effect so that they can extend inventory visibility across SDN to optimise the use of inventory and increase flexibility in response to short-term, or even long-term demand fluctuations.

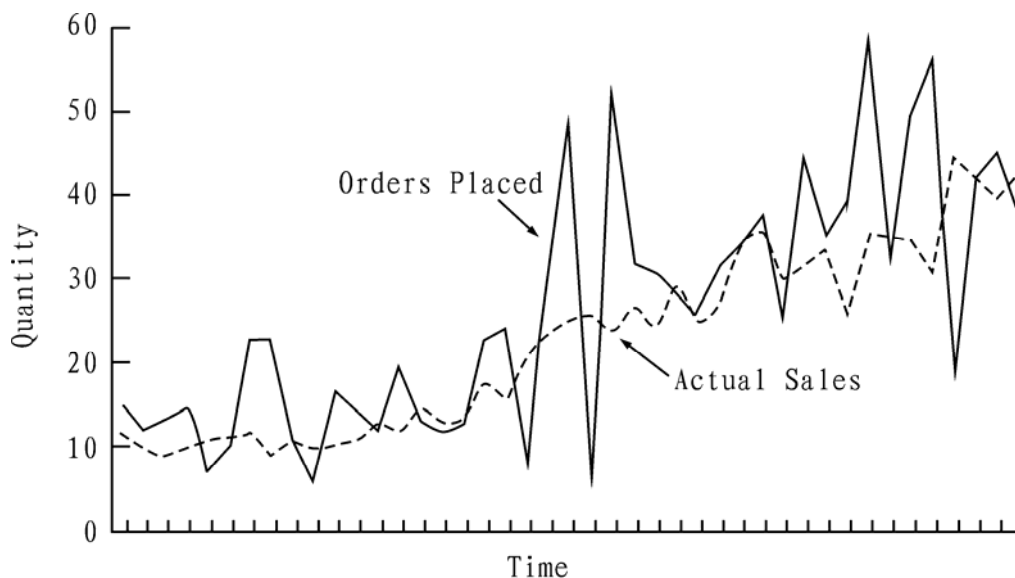

Figure 16. Higher variability in orders due to the Bullwhip Effect (Lee 1997a)

It is obvious that the bullwhip effect will bring significant negative impacts on inventory management and production within supply networks. Carlsson and Fuller (2000, 2001) summarized these negative impacts as follows:

1. Excessive inventory investments throughout the supply chain as retailers, distributors, logistics operators and producers need to safeguard themselves against the variations.

2. Poor customer service, as some part of the supply chain runs out of products due to the variability and insufficient means for coping with the variations.
3. Lost revenues due to shortages, which have been caused by the variations.
4. The productivity of invested capital in operations becomes sub-standard as revenues are lost.
5. Decision-makers react to the fluctuations in demand and make investment decisions or change capacity plans to meet peak demands. These decisions are probably misguided, as peak demands may be eliminated by reorganisations of the supply chain.
6. Demand variations cause variations in the logistics chain, which again cause fluctuations in the planned use of transportation capacity. This will again produce sub-optimal transportation schemes and increase transportation costs.
7. Demand fluctuations caused by the bullwhip effect may cause missed production schedules, which actually are completely unnecessary, as there are no real changes in the demand, only inefficiencies in the supply chain.

Lee et al. (1997a) also have identified four basic determinant reasons for the bullwhip effect:

1. The quality of the forecast and its update frequency.
2. The re-order frequency and the re-order batch size (order quantity).
3. Special price schemes, leading to speculative buying.
4. Expectation of shortage, leading to protective buying.

Based on preceding academic studies, Disney & Towill (2003) collected the causes of the bullwhip effect (Table 8). Disney & Towill divided these causes into four groups: the Forrester effect, which is caused by demand signal processing and lead-times; the Burbidge effect (order batching); the Houlihan effect, which deals with rationing and gaming against uncertainty, and the promotion effect, caused by price changes, discovered by Lee et al. (1997) and Fisher et al. (1997).

Table 8. Development of the bullwhip effect (Disney and Towill 2003)

	<i>Focus</i>	<i>Sources</i>	<i>Offered solutions</i>
Forrester effect, (Forrester 1961)	Time-varying behaviour of industrial organisations – Industrial dynamics	Feedback logic, feedforward logic, uncertainties, time delays and lead-times	Faster order handling, eliminating distribution level, changing inventory policy
Burbidge effect, (Burbidge 1984)	Production management	Problems in shop-floor control systems, uncertainties, time delays, multiple-cycle ordering, multiple-phased ordering, economic batch quantities	Avoid suing EBQ and MRP. Using systems theory principles to production management
Houlihan effect, (Houlihan, 1988)	Balancing inventories, production capacity and customer service in international supply chains	Local protection against shortages caused by upswing in demand, over-ordering causing unreliable delivery and increased safety stocks	Balancing inventories, production capacity and customer service
Promotion effect, (Lee et al (1997); Fisher 1997)	Effects of price changes	Price variation	Stable pricing Strategies

Considering that uncertainty is a major cause of bullwhip, Houlihan (1987) presented how the actions caused by uncertainties in the chain may result in amplified orders. If a shortage of a product occurs, this might cause over-ordering, since customers want to protect themselves against future shortages. This may cause demand amplification in two ways: first, the forecasts made by the parties upstream are based on larger demand, and, second, the over-ordering might cause more shortages, which in turn cause over-orders and increased safety stocking.

Since the development of the supply chain in the case company SLC, it has become a steel cooperative that has a multi-stage iron and steel supply chain, with two types of participants in the demands - the inner steel-making mill and the customers of the iron and steel markets. The market (iron and steel) demand is not constant; demand fluctuations occur quite often due to the fluctuating steel and iron markets.

4.4.2 Counteracting and Coping with Demand Fluctuations in Inventory Management

It is a fact that the demand fluctuations caused by the bullwhip effect might be hard to monitor and control in industry (in the case of this research, iron and steel products). According to the causes of demand fluctuations, there are related strategies to be aimed at counteracting the demand fluctuations. In inventory management systems, essential to counteracting the bullwhip effect is to first specifically understand what drives customer demand and inventory consumption, as they are the triggers for placement order quantities within SDN. The most effective process for counteracting the demand fluctuations by bullwhip effect is to understand what drives demand and supply patterns and then work collaboratively to improve information quality and compress cycle times throughout the entire process. Based on academic studies (Lee et al., 1997, 2000), Table 9 gives the related remedies for these causes of the bullwhip effect.

Table 9. Remedies for the bullwhip effect

Causes / Remedies	Information Sharing	Channel Alignment	Operational Efficiency
Demand Forecast update	Point of sale data (POS) ; EDI Computer Aided Ordering (CAO)	Vendor managed Inventory (VMI) Direct sales	Lead-time reduction
Order Batching	EDI	Outsourcing Consolidation	Set-up time reduction
Price Fluctuations		EDLP (every day low prices)	ABC approach
Rationing and shortage gaming	EDI	VMI	

Similar strategies by McCullen and Saw (2001) point out four principles on how to avoid the Forrester effect (bullwhip effect):

1. Control system
2. Time compression
3. Information transparency
4. Echelon elimination

In more detail, Donovan (2002) lists the actions to counteract the bullwhip effect, as follows:

1. Minimize the cycle time in receiving projected and actual demand information.
2. Establish the monitoring of actual demand for a product to as near a real time basis as possible.
3. Understand product demand patterns at each stage of the supply chain.
4. Increase the frequency and quality of collaboration through shared demand information.
5. Minimize or eliminate information queues that create information flow delays.
6. Eliminate inventory replenishment methods that launch demand lumps into the supply chain.
7. Eliminate incentives for customers that directly cause demand accumulation and order staging prior to a replenishment request, such as volume transportation discounts.
8. Minimize incentivized promotions that will cause customers to delay orders and thereby interrupt smoother ordering patterns.
9. Offer the products at consistently good prices to minimize buying surges brought on by temporary promotional discounts.
10. Identify, and preferably eliminate, the cause of customer order reductions or cancellations.
11. Provide vendor–managed inventory (VMI) services by collaboratively planning inventory needs with the customer to projected end–user demand, then monitor actual demand to fine tune the actual VMI levels. (Note: VMI can increase sales and profits especially in industries where buyers can go to alternative sources if stock–out.)

The above actions can give the ability to the manager of an inventory system to find opportunities for improvement and increase business performance by coping with demand fluctuations from the bullwhip effect. The company can apply these actions as much as it can. In the steel industry, some actions can possibly be used, e.g. action 3, 4,

8 and 11: however, some actions could be dependent on the situation in the company, e.g. with action 10 it might not be easy to identify and eliminate the cause of customer order reductions or cancellations.

Among these actions and strategies, information sharing in real-time and using Information and Communication Technology (ICT) has long been a major strategy to avoid problems in supply chain management such as the bullwhip effect. The case study in this thesis is also using the information sharing case.

4.4.3 General Counteraction to Demand Fluctuations in Traditional Industry

Even though much research has been devoted to demand fluctuations, however even the most modern of inventory management and supply chain management systems cannot completely stop demand fluctuations by the bullwhip effect when inventory management from the supply chain is shifting to SDN. What is the reason for this? According to the inventory model, the customer demand forecast (D_i) can be constructed from historical demand term and other aspects (Figure 17).

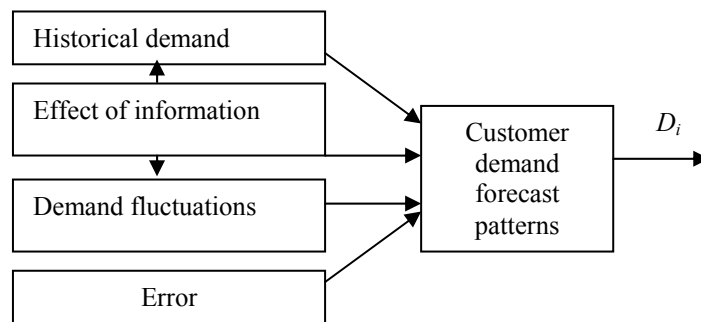

Figure 17. Customer demand forecast patterns

$$\text{Customer demand forecast} = \text{Historical demand} + \text{Effect of information} + \text{Demand fluctuations} + \text{Error } \epsilon$$

The first term— historical demand is used for any inventory model, since it is the crucial part and the demand information can be collected earlier. Thus, the historical demand analysis is a more important task, this capability analyses historical demand data for each product and identifies the appropriate demand classes such as seasonal, non-seasonal, erratic, lumpy. These problems will partly concern the second term— effect of information. In using demand data by information technology, a company's forecasting capability remains a crucial asset, since unreliable information results in inefficiencies in SDN. Moreover, the supply chain partners have mutual commitments. One form of such commitment is early order commitment. An early order commitment is a company purchase order, fixed in both quantity and delivery time, made by a retailer to the supplier earlier than a planned lead-time for manufacturing and delivery. Therefore, in using demand information in demand patterns by information technology, two things are important: (1) using the right information and (2) using the right forecasting model and software. The bullwhip effect has a negative effect on the first aspect. In recent years, various industries have embarked on industry-wide initiatives that promote information sharing and integration across the partners in the supply chain, which is a counteraction to the bullwhip effect that has been discussed. For the effect of information on demand forecast, there is a lot of software offering solutions for the right information and model, like Oracle Demand Planning (ODP) (2002), which is an Internet-based planning solution that can rapidly improve supply chain performance by improving the predictability of customer demand and enabling collaboration and consensus. Oracle Demand Planning is part of the Oracle E-Business Suite, an integrated set of applications that are engineered to work together. Even so, in demand patterns, the third term— daily/weekly demand fluctuations are still a problem for companies, and then fluctuations are also related to the effect of information technology, i.e. the second term could impact on the third—demand fluctuations that have been discussed in the previous section. The fourth term is random error, which is difficult to avoid.

Returning to inventory models, most EOQ models just consider the first term— historical demand, which assumes that demand is stable or its varying is constant, e.g. Q system,

S system and (Q, S) system, even though some models consider Probability Density Function (PDF) of demand, which partly considers the effect of information. However, they have not considered demand fluctuations by the bullwhip effect in inventory models in SDN. Other inventory management models have been trying to update the customer demand to reflect actual demand–variation in SDN, not only in historical terms, but also in information distortion terms; e.g. Lee et al (1997c) model some special cases by real examples. Thus, an effective inventory model could forecast demand that reflects demand fluctuations; however, this is not enough. Inventory management could also counteract these demand fluctuations. Since the proposed FICM in this chapter aims to reduce inventory level and costs, this research will not focus on how information works with inventory models and how demand fluctuations impact on supply chain network inventory management, but will investigate how the proposed FICM copes with demand fluctuations.

4.4.4 Application of Proposed FICM to Counteract Demand Fluctuations

There are a number of researchers in recent years, who have been interested in using fuzzy logic control to counteract demand fluctuations that have been discussed in the previous section and in Chapter 2. By the proposed FICM, with related counteracting strategies, this research aims to apply the FICM counteracting demand fluctuations.

As an illustration for multiple stage inventory management control structure decisions and a simplification, we model an SDN (Figure 18) with a supplier–materials supplier (in the case of this research, raw materials plant), which supplies two downstream plants under exogenous stochastic customer demand. An additional raw material supplier and the end customer are included for completeness. Using this model, the performance of counteraction to demand fluctuations under stable and dynamic demand conditions are discussed under related industry conditions. Additional fuzzy theory analyses are used to test the effectiveness of the FICM in SDN.

From a stage perspective, there are two levels in the supply network hierarchy: material supplier (material plant in the case of this research) and factory (in the case of this research: BF, BOF). From a channel perspective, there are two supply chain channels, A and B. For example, the raw material plant sends materials to (BF1), which is in the supplier–tier stage and in supply chain A. BF1 also sends its product (iron) to company 3 (BOF1, factory stage, chain A), which makes the production process (BOF) and sends it to the final customer (including downstream factory/customers). The customer also has the choice of using supply chain B, which is composed of Company 2 (supplier stage, supply chain B) and Company 4 (factory stage, supply chain B). Using this model, we can discuss ways of counteracting demand fluctuations and inventory management using counteracting issues.

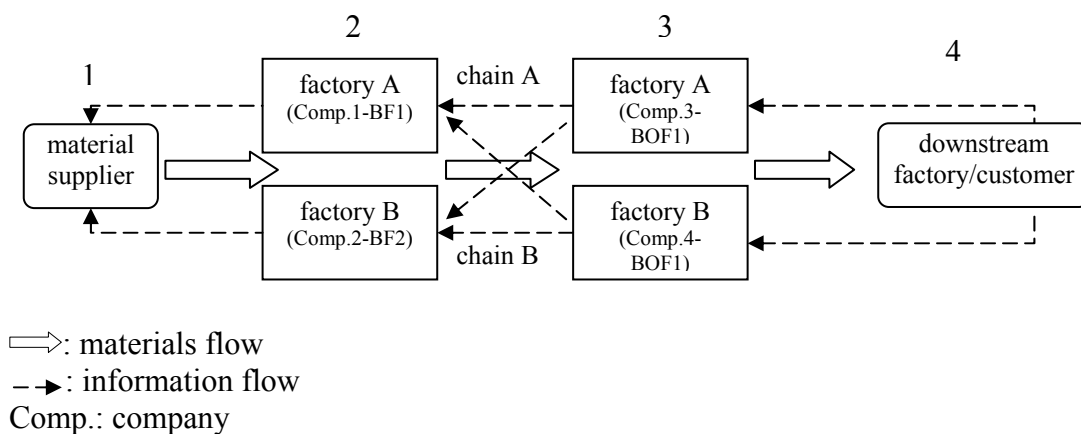

Figure 18. Supply network structure model in the iron and steel industry

As said earlier, information sharing will be used in the proposed model for counteracting demand fluctuations. According to this action, “Avoid Multiple Demand Forecast Updates” can be used and will make demand data at a downstream site available to the upstream site; this results in the upstream site (materials supplier) using demand data from the end customer, which crosses chain A and B, integrates forecasting data from the same demand data, and both sites can then update their forecasts with the same raw data from the end downstream site.

“Break Order Batches” (Lee et al. 1997a) are not available in the case of this research – the iron and steel industry, even though it is helpful in the general electric and computer industries. In heavy industry, the normal order quantity is enough for the full truckload constraint of the same product, or even more so in the iron and steel industry.

“Eliminate Gaming in Shortage” (Lee et al. 1997a) is available in the iron and steel industry. Due to higher economic growth, shortages of steel products might occur. The international Iron and Steel Institute (IISI) is anticipating a much stronger growth of demand. China is currently projected to account for 61% (58mmt) of the forecasted two-year global increase of 94 mmt in 2004 and 2005 (IISI, Short Range Outlook for 2004–2005). According to Lee’s statement, ‘Gaming’ occurs during shortages and peaks, when customers have little information on the manufacturers’ supply situation. The sharing of capacity and inventory information helps to alleviate customer anxiety and, consequently, lessen their need to engage in gaming. But sharing capacity information is insufficient when there is a genuine shortage. Some manufacturers work with customers to place orders well in advance of the sales season. Thus, they can adjust production capacity or scheduling with better knowledge of product demand. In view of this action, the producers and customers could follow related reports so that they could capture related trends, e.g. from IISI. However, the different tiers have different main points for their downstream partners, for example: the materials supplier can only cross the chain to get end demands, since it acts a major supplier to the chain (A and B). However, the other downstream tiers should investigate different kinds of product, which its downstream tiers lack or are in excess of. Comp.1–BF1 and Comp.2–BF2 should know how iron products are going in the market, including pig iron, cast iron, bloomery iron, and Comp.3–BOF1 and Comp.4–BOF2 should know how steel products are going in the market, including stainless steel, strip steel, and so on. However, the intermediate partners and downstream partners demanding information do not impact on the first tier partner—the materials supplier, which is a total supplier to the other partners.

“Stabilize Prices” is available but it is a difficult task for iron and steel-makers to do alone. In the steel industry, the price is influenced by many factors, but a major factor is

the material price and the demand of economic development. Iron and steel-makers cannot easily make an attractive price offer without customer demand and global economic growth. In this industry, the price fluctuation is mainly dependent on economic development. It is also influenced by the actions of central government, like cooling actions in terms of its overheated steel industry, or a medium-term capacity adjustment. In view of this, the partners in inventory management could pay attention to economic trends and related government reports.

Besides information sharing and avoiding multiple demand forecast updates, the FICM could be used in raw materials management, which has been discussed in detail in the previous chapters. Theoretically, information sharing through coordination and collaboration is available when the partners have common benefits from supply chain networks, e.g. cooperative network. Since the cooperative partnership model focuses on developing long term relationships with suppliers who are often given implicit guarantees on future business, with this cooperative relationship companies build trust with suppliers, and collaborate with partners in production and inventory planning. In return, suppliers make relationship-specific investments, which, in turn, enhance the productivities of the entire supply chain/network. It is well known that successful cases such as Dell and HP use information technology to successfully operate massive collaborated supply networks in which each specialized business partner focuses on only a few key strategic activities. In contrast, there are a number of companies using the traditional arm's-length model-competitive relationship. This advocates minimizing dependence on suppliers and maximizing bargaining power (Porter, 1998). Competition among the suppliers is encouraged, with the benefit of cost reduction and economic efficiency resulting to the purchasing firm. In the case of competitive supply chain networks, information sharing by coordination and collaboration is difficult. Unfortunately, a number of supply chain networks are still the traditional arm's-length model, i.e. competitive relationship. In the iron and steel industry, it is possible to build a cooperative partnership within supply chain networks so that the inventory management can easily facilitate information sharing for each partner. However, in the case of the competitive model, inventory management should look for effective

strategies and policies to cope with demand fluctuations besides information sharing. The proposed FICM is an alternative to cope with demand fluctuations besides reduction of inventory level and costs, both in cooperative or competitive networks. For cooperative networks, this permits integrated information sharing for the inventory manager to demand input to the FICM. For competitive networks, where information sharing is not easy, it is possible to use the FICM for the inventory management of each stage. In the network model (Figure 18), a fuzzy controller can be built for inventory management in each connection, between 1–2, 2–3 and 3–4. According to this case – the iron and steel industry, feeding product between BF and BOF processes does not need inventory, as the hot iron is sent to BOF process directly. Hence, the model has just 2 connections: 1–2 and 3–4 (Figure 19.).

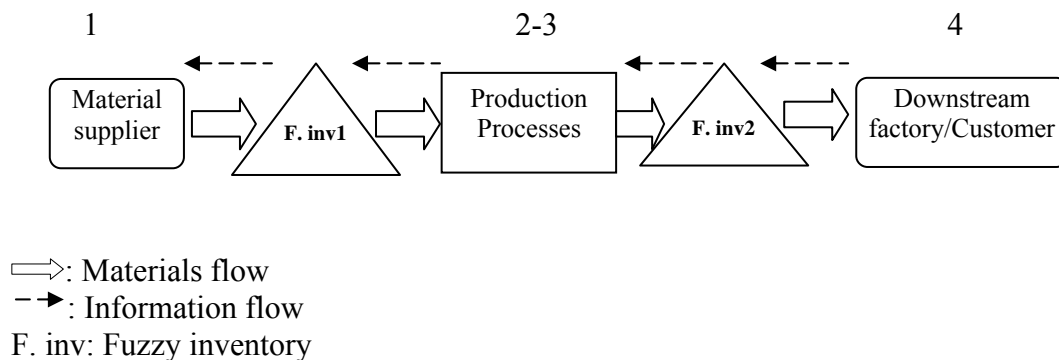

Figure 19. FICM in SDN

According to the case study in the following chapter, this research attempts to illustrate the capabilities of the fuzzy model in terms of demand fluctuations. More specifically, the four exercises conducted here include:

1. Effective ways of counteraction from related literature
2. The impact of fuzzy control on inventory management
3. Damping effect of the FICM on demand fluctuations
4. Demand–magnification effect of the FICM.

First, information sharing can be applied as far as possible as the company can. In detail, for the case company in the iron and steel industry, the BF–iron–maker and BOF–steel–maker can share the same consumption data for their production planning and inventory management. This is reasonable when the case company has developed its own inner steel–making. With the case study, this research gives a comparison of the classical inventory model with the proposed FICM by fuzzy controller with and without an information sharing case.

The application procedures for the fuzzy controller in each stage are similar to the previous section. The part for the fuzzy controller of each stage should consider fuzzy rules, fuzzy operator's MF (membership functions), and defuzzifications. Here, this study extends FICM in SDN from the single– stage fuzzy model.

To extend FICM in SDN, for the demand, inventory level and order in each stage, each universe of discourse should be assumed to be different, as U_{d-nb} (universe of discourse of demand), U_{i-nb} (universe of discourse of inventory), and U_{o-nb} (universe of discourse of order). They can be restricted by:

$$U_{d-nb} \in (0, X_{d-nb}), U_{i-nb} \in (SS_{nb}, X_{i-nb}), U_{o-nb} \in (0, X_{o-nb})$$

Where

nb = the number of each fuzzy model in each stage

X_{d-nb} = $2 \times$ Average weekly demand in nb stage

X_{i-nb} = Re–order point in nb stage

X_{o-nb} = $2 \times$ Average ordering (purchasing) quantity in nb stage

SS_{nb} : Safety stock in nb stage for inventory

Theoretically, for multiple stage inventory management in supply chain networks, the fluctuations will be less and less from the end partner to the beginning partner with multiple fuzzy inventory controllers for each stage. Basically, companies should consider avoiding multiple demand forecast updates first, and then build multiple fuzzy inventory models in each stage, which cannot avoid multiple demand forecast updates. Therefore, the multiple FICM (Figure 20) are given by:

$$\text{MEF} = \text{Multi-echelon fuzzy model } (F_{inv-1}, F_{inv-2} \dots F_{inv-nb} \dots) = f \{ [F(\text{Rule}_{-1}, \text{MF}_{-1}, \text{Inference}_{-1}, \text{Def}_{-1})], [F(\text{Rule}_{-2}, \text{MF}_{-2}, \text{Inference}_{-2}, \text{Def}_{-2})] \dots [F(\text{Rule}_{-nb}, \text{MF}_{-nb}, \text{Inference}_{-nb}, \text{Def}_{-nb})] \dots \}$$

Where

MEF = multi-echelon fuzzy model

f = MEF is the function of the each fuzzy controller in each echelon inventory

F_{inv-nb} = fuzzy model in nb th echelon = $F(\text{Rule}_{-nb}, \text{MF}_{-nb}, \text{Inference}_{-nb}, \text{Def}_{-nb})$

Rule_{-nb} : fuzzy rule in nb th stage inventory

MF_{-nb} : membership function in nb th stage inventory

Inference_{-nb} : fuzzy inference in nb th stage inventory

Def_{-nb} : defuzzification in nb th stage inventory

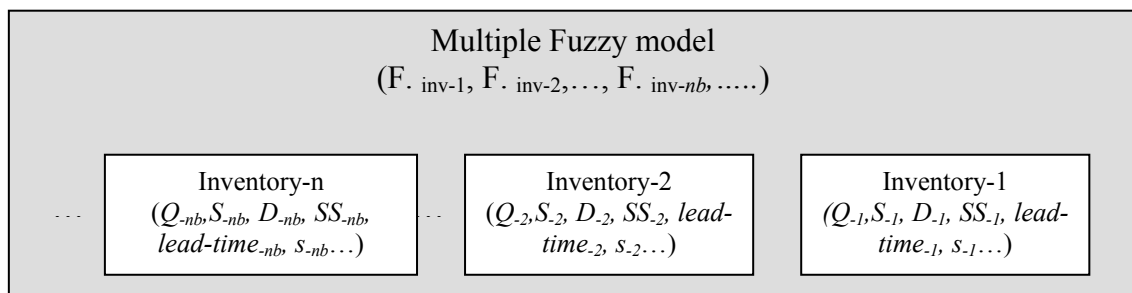

Figure 20. Multiple FICM in SDN

How can companies create a truly fuzzy inventory management system in SDN and successfully pursue the integrated counteracting strategies and fuzzy logic issue to demand fluctuations by the bullwhip effect or demand–magnification effect? They may follow a systematic procedure comprising the following steps (see Figure 21):

1. Perform an SDN audit. With this step, the company needs to understand all partners in networks, including suppliers, upstream factories, downstream factories, customers, customer requirements, each partner relationship (cooperative or competitive), and the points of connection and disconnection between each partners.

2. Set inventory nodes and goals. The company should attempt to set intermediate inventory nodes as little as possible so as to avoid multiple demand forecast updates. Moreover, the company must also attempt to build cooperative relationships with partners.

3. Make a bullwhip effect analysis and figure out different demand fluctuations. With this step, the company should perform a thorough analysis of the bullwhip effect in SDN and its impact in inventory management system, as revealed by the supply chain audits. The identified normal and controllable fluctuations that are not caused by the bullwhip effect should be highlighted with the nature of the task in formulating strategy, for example, seasonal fluctuations in the food and clothing industry, uncertain rebuild (e.g. after earthquake, natural disaster) in the steel industry. The company should identify its strong points and weak areas.

4. Formulate counteracting strategies to demand fluctuations from the bullwhip effect. With this step, the company should decide how it should apply related counteracting strategies in the inventory management system within its supply chain. The focus should be on developing a counteracting approach to demand fluctuations by counteracting strategies and new solutions. Therefore, this is a critical step, since it decides the company's ways to integrate itself in the industry and supply chain network and sets up the implementation.

5. Design an inventory management model. According to the inventory management goals, the company can set up an important implementation that is cost–effective and reduces the inventory level. Meanwhile, the company should design its inventory

management system to have counteracting strategies to demand fluctuations. In the case of this research, the FICM is the key to successful implementation of these goals.

6. Set up an implementation of multiple FICM. The company should offer related data to the fuzzy controller in different stages. Some data could be shared in some node when a cooperative relationship could be used.

7. Develop the fuzzy controller in the FICM. This is a critical step for implementing. The related procedures and fuzzy issues are a continuous design process and should be better tuned with the different parameters in different nodes.

8. Monitor results and revise goals. The company's performances in the measurement will have to be monitored. These performances could be based on either the company's inventory management goals, for example, some criteria as listed in Chapter 5 of the case study. Based on the monitored results, the company can redesign the inventory management system to pursue a successful strategy.

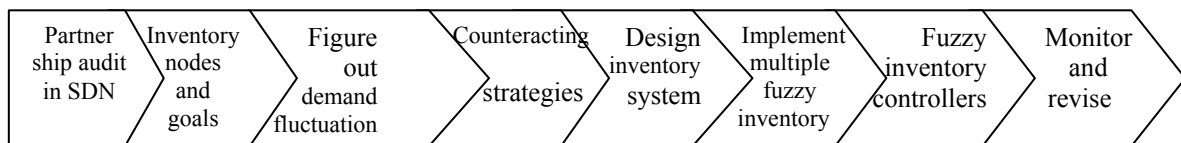

Figure 21. Implementing counteracting strategies and FICM (Author)

5 CASE STUDY

5.1 Overview

An iron and steel company can benefit from the savings and efficiencies of supply chain management. This case study particularly investigates the raw materials supply chain inventory for the iron and steel production process in SLC. As stated in Chapter 1, this research effort seeks to apply effective inventory control model for the raw material plant, which belongs to Company “SLC”. The FICM has been proposed in the previous chapters; the case study in this chapter will give the experimental verification to answer the research questions, with the data obtained from Company “SLC”. Modeling and the simulation will examine the following questions:

- Can the proposed fuzzy control model based on a fuzzy logic controller combined with the (s, S) policy provide improved performance in cost and inventory level?
- Can the proposed model improve the inventory control in a stochastic demand case and demand with imprecise fluctuation case caused by changed markets, when the steel supply chain is faced with fluctuating demand? And
- When the single supply chain shifts to a multiple–stages supply–demand network, can the proposed model be extended to a multiple stages supply–demand network and improve the ability to counteract the demand–magnification effect when demand fluctuations are considered?

Before the experimental modelling and simulation could take place, there were a number of preliminary actions that had to be taken. First, some related data had to be obtained from Company SLC (Figure 22, 1.). Next, the value of related data and parameters were developed by preliminary statistics & computing (Figure 22, 2.). Then, the raw materials inventory model of the plant had to be produced, and different demand distributions were created (Figure 22, 3.). Then, all these elements had to be

tied with two inventory models, which are the extension (s, S) policy and the proposed fuzzy model that uses the fuzzy logic controller combined with the (s, S) policy (Figure 22, 4.), and the experiments started. This chapter discusses the above actions and finally provides details on modelling and simulation of inventory control associated with the related control technique.

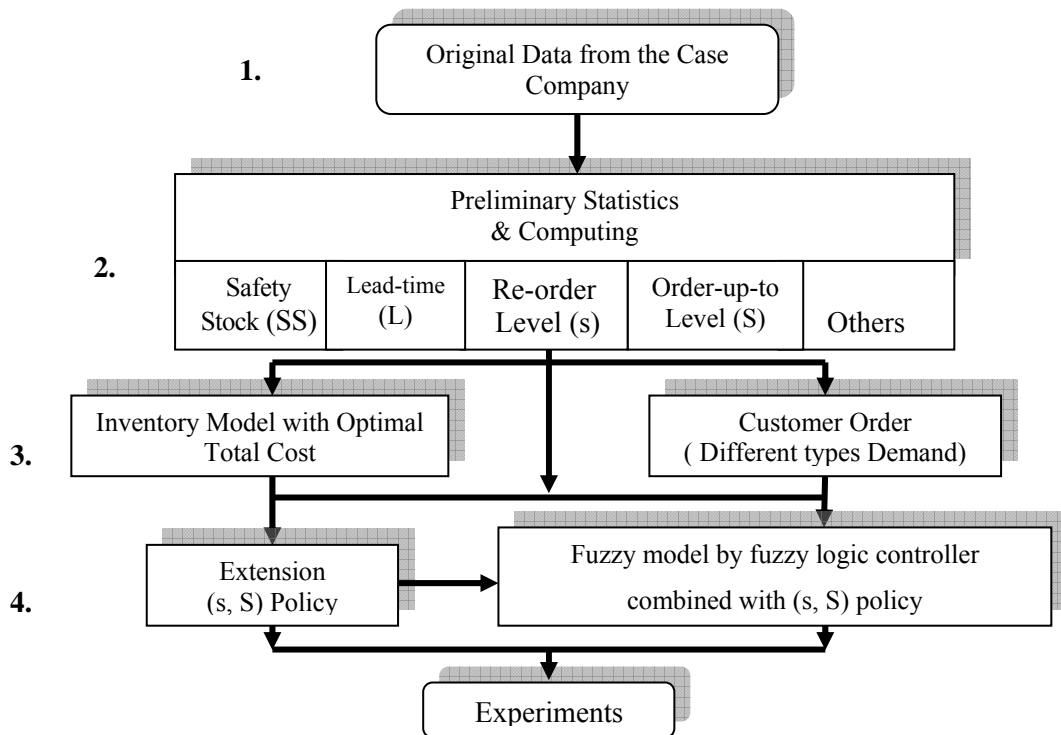

Figure 22. Flow chart of case study

5.2 Preliminary Outline

A current statement on problems dealing with SLC was made in Chapter 1. In this section, special emphasis will be given to some key problems, which should be addressed before the experimental simulation.

5.2.1 Technological Challenges Facing Raw Materials Inventory in SLC

This case study deals with raw material inventory in SLC, which is a typical iron and steel company in the west of China. The company orders the items from a supplier, and then keeps an inventory of items in the materials plant, which is responsible for feeding out the items to the production process.

Figure 23 shows that the iron and steel is made by using the blast furnace (BF). The BF process first makes iron by smelting the raw materials in a blast furnace and then using the iron to make steel in a basic oxygen furnace (BOF), or selling in the market. The case study will concentrate on the inventory control model that feeds materials into the production process.

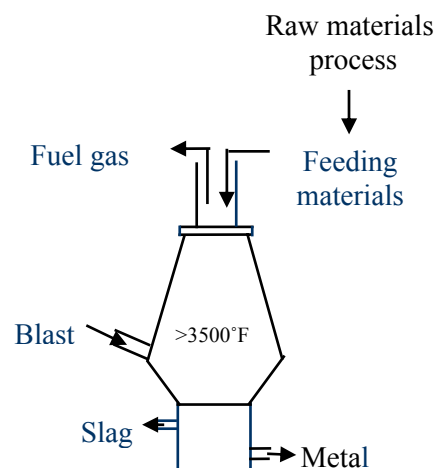

Figure 23. Blast Furnace (BF)

SLC has established an inventory model (Figure 1 in Chapter 1) for the raw material ordering and feeding to the production process. According to its producing scheduling and inventory model, the annual steel product is evaluated in advance; consequently, the specification of the inventory control model entails the calculation of the base inventory level and safety stock *SS* that not only fulfils the BF process requirements uninterruptedly, but also maintains the production for some time. Currently, the calculation is based on the guarantee of sufficient stock so as to satisfy the feeding of

the BF process uninterruptedly. The company evaluates S (inventory level) and SS (Safety Stock) as the feeding that satisfies demand during the replenishment lead-time and will not exceed the lowest inventory level or safety stock SS . By this inventory model, the inventory manager would evaluate the order of all materials only at one time for one year. The model evaluates the forecast demand of materials and annual cost at the end of the previous year, and the order will be placed in a different period in this year. During the year, it checks the inventory with safety stock bi-weekly based on previous experience and demand, but it does not take into account the changing market of steel and iron demand. The company would then pull the data in from the control system and combine it with the needs involved in creating its production schedule. In the case study, the re-order point (s) equals safety stock (SS). The company will require supplying as soon as the company reaches a too low inventory level (around SS), i.e. the inventory level becomes lower than $s=SS$, and the available inventory just after the previous period has been retrieved from inventory and a replenishment order has been issued.

Example

The annual production is 200 0000 tons (200 million tons) in the company, 60 percent of the materials is iron ore, and its output-rate is 95 percent. Hence, it is calculated that the annual average demand for iron ore = $200\ 0000/0.6/0.95 = 35100\ 0000$ ton /annum, the store operates = 52 weeks/year, so the average weekly demand is given by: $D_{avg_I} = 351000\ 000 /52 = 6750000$ tons/week. Meanwhile, the other calculations are made according to the company's opinion. SS must take into account around 2–3 weeks materials feeding to the BF process, that is $SS = \text{Average weekly demand} \times 2.5$ weeks. For iron ore: $SS_I = D_{avg_I} \times 2.5$ weeks = 6750000 tons/week $\times 2.5$ weeks = 16875000 tons, providing a service level of 100%, i.e. it fulfils the BF process requirements uninterruptedly, but also maintains the production for around 2.5 weeks at least.

The above example shows the current order policy is certainly easy to apply; the problem with the current model, as described above, is that too high a stock level incurs too high costs in terms of materials to the production process. This is not always

justifiable, since it retains too much active money for a long time and lacks flexibility, because it does not consider the changing demands of the market. In terms of the entire steel supply chain, as stated in Chapter 1, there are now two types participants in terms of the demands – the company's own inner steel-making and the customers of the iron markets. The demand from the inner steel-making mill may be stable or known, but the real market (iron) demand is neither so constrained nor so tidy, the demand fluctuations occur quite often because of the stochastic steel and iron markets, and this brings the case company's production to an incomplete push system when its supply chain considers these fluctuations. Under these circumstances, the old inventory policy is not an appropriate model; it causes major problems for SLC in not only excessive stock with respect to incomplete push production, but also shortages or emergency orders which occur occasionally when sharp demand fluctuation happens. This means, in fact, that the old inventory policy was weak in terms of the fluctuating demand caused by changing markets when used in the developed supply chain and incomplete push production. As stated in Chapter 1, an excessive inventory must bring a number of problems, e.g. it consumes physical space, creates a financial burden, and increases the possibility of damage, spoilage and loss. Another problem encountered by the excess inventory level is environmental pollution. Moreover, a weak ability to counteract the fluctuating demand caused by changing markets must result in inefficient management, poor forecasting, haphazard scheduling, and inadequate attention to process and procedures. In short, this inventory model is inefficient and inflexible. It is realized now that a better inventory model could be used for the raw materials inventory in SLC. This proposed model is not only able to satisfy the feeding of production uninterruptedly, but also consider both the company's own inner stable or known steel-making and the stochastic steel and iron markets. In this case the technological challenges facing the raw materials inventory in SLC give a choice of an effective inventory control model for the company to reduce the inventory cost and the demand fluctuation in its inventory management.

5.2.2 Numerical Illustrations

In Chapter 3, some items about inventory control were discussed, which should now be used in the preliminary modelling work. The detailed descriptions are as follows:

Planning horizon: As an iron and steel company, SLC should guarantee uninterrupted production of iron and steel-making everyday (365 days, or 52 weeks). An inventory model will be created based on annual cost, meaning the planning horizon is one year. For the iron and steel industry, this means 52 weeks.

Number of items: For the downstream of the raw materials plant, the BF process needs feeding with the main different raw materials. Among these, iron ore, coke, limestone, and coal powder are regarded as the main items. Hence the inventory model should be a multiple-item model, and the number of items is 4.

The products: Feeding the BF the process are mainly iron ore, coke, limestone and coal powder. In the inventory model, it seems that a multi-item inventory model should be used, since there is more than one item. The model, however, can calculate the amount of ordering of other items by their mathematical relationship with the amount of iron ore, since iron ore is the most dominant item among the raw materials. In this case, the amount of coke, limestone and coal powder are in proportion to the iron ore (5–1). Hence it is possible to treat the inventory control as single-item. In detail, it could first focus on the ordering amount of iron ore, then obtain the amount of other items by their mathematical relationship with the amount of iron ore.

$$\text{Iron Ore: Coke: Limestone: Coal Powder} = 1 / 0.6: 0.40: 0.14: 0.1 \quad (5-1)$$

Demand process: Considering the demand generated in the material inventory as real demand, the weekly demand for iron ore and other items is uncertain, but it can be described by several different distributions that are typical distributions along with market demand in practice. Although the company could not really expect that demand

would be static, we did not have data to model that explicitly. This research attempted to several different demand distributions were generated by random number and the relative demand information from the historical data given by SLC.

The company's policy is to satisfy all demand for feeding the production process. When the fluctuating demand from the stochastic steel and iron markets is considered, if demand cannot be satisfied completely from the on-hand inventory, an emergency-order will be placed at the end of the period for the shortage. This order will arrive virtually instantaneously, but at a steep cost, which is higher than normal. In the case study, the shortage or emergency-order will appear when one order needs to be placed, and the inventory level will be low and close to safety stock (SS), e.g. $SS \times (1+5\%)$.

At the beginning, the current inventory of the iron ore, etc., including any that might have just arrived, is $SS \times (1+5\%)$. There are no other orders on the way. The raw materials plant has to send the items uninterrupted to the BF process, since the iron and steel production system is a continuous production process, which needs uninterrupted feeding with the raw material inputs. It also needs to operate 52 weeks per year.

Service level: Service level is defined as the percentage of demand in linear feet met from stock (Nahmias 1989). According to different industries, higher service requires just slightly more frequent runs and different higher safety stock. In the case of the SLC – BF process, service levels must be 100%, requiring significant safety stock under normal operating conditions according to the above definition. However, for service level taken into account in the inventory management, here service level in this case study is defined as the percentage of inventory level holding in linear feet met from safety stock (SS), which is different from the above definition. For example, if the inventory level for each period is higher $SS \times (1+5\%)$, then service level is 100%. It is easy to test the service level in the case study with this definition.

Lead-times: Shipping the items by train would reduce the lead-time considerably, and it is also cheaper. Thus, railways are selected as an option. The supplier takes about 2–3 days to get the materials ready, then the transportation time from the supplier in another province to the local province or other counties is 1–2 days, and the time to the raw materials plant in SLC adds another 2 days. Finally, an average of 5 to 7 days is needed to take the items from the supplier to the SLC. Thus, an average total lead-time is had for the iron ore of 7 days (all days considered are calendar days), which is constant. Therefore, if an order is placed now, it will arrive after 1 week.

Review process: Periodic review will be used in the case study, and the period (equal time intervals) will be selected as every week (1 week) for the iron and steel industry.

Costs structure: By first focusing on the ordering amount of iron ore, the inventory cost associated with each item should be essentially the same as in the case of an equivalent single-item model [See (3–2)]. The problem thus becomes:

$$\min COST \text{ Annual} = CTU = CT_1 + CT_2 + CT_3 + CT_4 = \sum_{k=1}^j CT_k \quad (5-2)$$

Where CT_1 , CT_2 , CT_3 and CT_4 are the minimal total inventory costs of the items: iron ore, coke, limestone, and coal powder, and CTU is the annual total inventory cost of all items.

Based on (3–2), I_1 , I_2 , I_3 , I_4 can be substituted by S_k , OT_k , Q_{sk} , and Q_k for each item in the case study, and the cost is given by:

$$\min COST (S_k, Q_{sk}, Q_k, OT_k) = CT_k = \sum_{i=1}^n [\sum_{k=1}^j (h_k S_k)_i + (g_k Q_{sk})_i + (c_k Q_k)_i] + K_k OT_k \quad (5-3)$$

Each parameter of the cost structure is now stated and their values provided by the company in detail, as follows:

Ordering costs K_k (Yuan/order): two main components can be identified in the ordering cost for the items: the first component is the transportation cost from the suppliers to the port of local province and until the raw materials arrive at the raw materials plant in SLC; and the second component is the cost associated with the handling of documents, insurance for shipment, and unloading.

Thus, the first component represents the railway transportation cost and is included in the cost of the items. As stated in Chapter 1, a lot of trains and shuttle buses are operated in the region each day. Since the nationwide railway system is integrated and managed by the government, there will be no shortage of available trains.

Chapter 1 has stated that the transportation cost will be only considered with full containers. In general, a replenishment order is more than one container, always full, and the total cost will be the sum of the costs associated with the container sizes involved in the transportation according to the cost per container previously presented. For the sake of simplicity, the case study does not take separate transportation costs for full containers or less-than-full containers per order into account. The company provides annual average transportation costs per order as the ordering costs. The second component associated with the handling cost is also provided as annual average cost per order by the company.

In total, the company has considered both the above components and provided the ordering costs in 10 percent of the purchasing costs as:

$$K_k = [5.5; 8.4; 1.4; 4] \quad (\text{Yuan/ton/order}) \quad k \in [1, j], j=4$$

Holding costs h_k (Money/unit-time period): according to the rule in Chapter 3, the total holding costs are proportional to the level of inventory and vary directly with the storage duration, meaning the holding costs are linear. The company provided the holding costs as:

$$h_k = [14; 21; 7; 10.5] \quad (\text{Yuan/week}) \quad k \in [1, j], j=4$$

Clearly, the company may adapt the holding costs of keeping inventory continuously in the materials inventory system when the raw materials are kept in the materials plant.

Purchasing cost c_j (Yuan/t): The costs provided by the company are normal prices without discount in the following:

$$c_k = [550; 840; 140; 400] \quad (\text{Yuan/ton}) \quad k \in [1, j], j=4$$

But the supplier offers the following quantity discount structure for iron ore, which will be effected by the order quantity (Figure 24), the discount steps are as follows:

- If $1 < Q < q_1$, then purchase cost/ton = 550 Y/t normal price
 - If $q_1 < Q < q_2$, then purchase cost/ton = $550 \times 95\% = 545$ Y/t less 5%
 - If $Q > q_2$, then purchase cost/ton = $550 \times 90\% = 495$ Y/t less 10%
- Note: Y/t: Yuan/ton

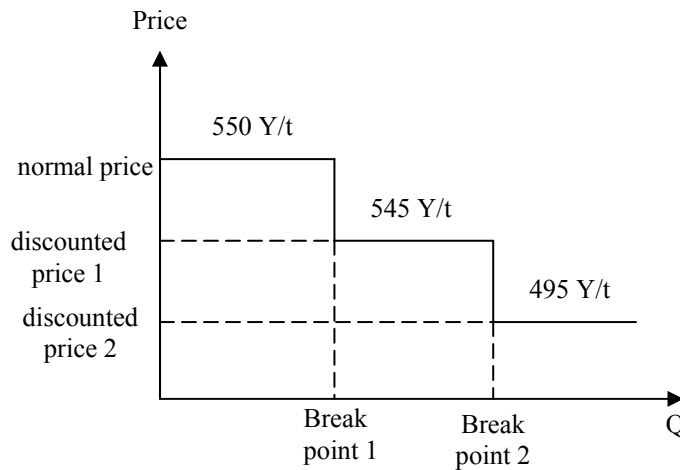

Figure 24. Quantity discount structure for the iron ore

Here, as mentioned in Chapter 3, it is taken into account that purchase costs can vary with order quantity; the cost of a unit is now no longer fixed but a variable ($c = f(Q)$) of

the order quantity Q). In this case, the company pays the same price for all units ordered, and the price drops when the order size reaches the *break point*.

Note that the price break only happens with iron ore, since a large amount is needed in the BF process, and the company does not receive the price breaks for other items, since they are not large amounts compared with the iron ore.

Shortage (Emergency-order) Cost g_k : theoretically, no real shortage occurs when feeding the items uninterruptedly to the BF process, since the iron and steel production system is a continuous production process needing uninterrupted feeding. But it is possible that the inventory level goes too low sometimes. An emergency-order was set in this case. Whenever an emergency-order occurs in advance during review, the company must be charged in a complete back ordering system, which is higher than the normal purchasing cost as an emergency purchase cost. It is important to note here the difference between the definition of shortage in this research and one often used in inventory systems. People frequently use this word shortage to express that on-hand stock can not satisfy demand, which should be zero on-hand stock. The definition in the case industry – iron and steel, more commonly expresses on-hand stock as near to safety stock (SS).

As the lead-time is taken into account, the current forecast inventory level should consider the order quantity at lead-time early. Therefore, forecast inventory at lead-time (L) from now is given by:

$$f_{inv}(i-1) = S(i) + (L \times D_{avg}) + \sum_{k=i}^{i+(L-1)} Q_k$$

We set an order to appear when the forecast inventory level (considering lead-time) is much lower than the re-order point and close to the safety stock SS . The logical judgements are given by the inequality, as follows:

$$\begin{array}{ll} f_{inv}(\text{Forecast inventory level}) < s & \text{ordering is placed} \\ SS \leq \text{inventory level} \leq SS(1+5\%) < s & \text{emergency order appears} \end{array}$$

The costs for each item given by company are the following:

$$g_k = [610; 870; 150; 420] \quad (Y/t) \quad k \in [1, j], j=4$$

Since the demand–magnification effect in this case study is a similar phenomenon to the bullwhip effect, the measuring of the bullwhip effect is provided first. A commonly used methodology exists for measuring the extent of the bullwhip effect in a supply chain. The variation of demand at a certain stage in the chain is described as the standard deviation of the demand divided by the average demand during a certain interval of time. This is calculated for both incoming and outgoing demand at the stage – and the demand at any two points in the chain. The extent of the bullwhip effect is the quotient of the coefficient of variation of demand generated by this (set of) stage(s) and the coefficient of variation of demand received by this stage:

$$\text{Bullwhip } (\omega) = \frac{c_{out}}{c_{in}}$$

Where

$$c_{in} = \frac{Std_D_{in}(t, t+T)}{Mean_D_{in}(t, t+T)}$$

$$c_{out} = \frac{Std_D_{out}(t, t+T)}{Mean_D_{out}(t, t+T)}$$

D_{in} and D_{out} are the incoming and outgoing demands during the time interval $(t, t+T)$; $Std_$ and $Mean_$ are the standard deviation and mean of the demand, respectively. In the proposed fuzzy inventory supply chain with 2 stages (Figure 27) in the case study, each stage consists of inventory, order and demand; we distinguish between demand coming from the next downstream stage (D_{in_1}) and demand going out to the next upstream stage (D_{out_1}). Demand of upstream (D_{in_2}) is usually affected by placing orders from the downstream (D_{out_1}). $c_{out|Order}$ is used to express c_{out} that is the function of order; and $c_{in|Demand}$ is the function of demand. Since the demand–magnification effect in the case

study is similar to the bullwhip effect, the measurement of demand–magnification effect in the case study follows the same as the above measurement of bullwhip effect. All demand–magnification effects will be calculated in each stage for the one and two–stage inventory system by both classical and fuzzy model in the case study.

Damping effect of inventory to demand fluctuations:

As with the demand–magnification effect calculation, the damping effect of inventory to demand fluctuations is also calculated to investigate the counteraction to demand fluctuations. It is defined as $Damp = \frac{Std_S - Std_D}{Std_D}$. Std_D and Std_Q are the standard deviation of demand distribution and order quantity, respectively.

Others:

There are other factors that influence the cost model besides the above parameters. The details are as follows:

Average weekly demand D_{avg} (unit/week): in the iron and steel industry, the collected data is weekly, so that the data used in this case study is also weekly. The annual production is 200 0000 tons in the company, 60 percent of materials is iron ore, and its output–rate is 95 percent. Hence, iron ore’s annual average demand (D_{avg_I}) = 200 0000/0.6/0.95 = 35100 0000 t /annual, annual store operates = 52 weeks/year, then the average weekly demand is given by:

$$D_{avg_I} = 35100\ 0000 / 52 = 6750000\ t / \text{week}$$

(Note: footnote 1 expressing the first item: iron ore, will not be repeated subsequently)

Max. weekly demand Mad_1 (ton): $351000000 / 52 \times (1 + 12\%) = 7560000\ t / \text{week}$

Min. weekly demand Mid_1 (ton): $351000000 / 52 \times (1 - 15\%) = 5737500\ t / \text{week}$

Safety Stock SS (ton): SS must taken into account around 2–3 weeks (we set to 2.5 weeks) material feeding to the BF process, that is $SS = \text{Average weekly demand} \times 2.5$ weeks. For iron ore:

$$SS_I = D_{avg_I} \times 2.5 \text{ weeks} = 6750000 \text{ t / week} \times 2.5 \text{ weeks} = 16875000 \text{ ton}$$

s_I (**ton**): the re-order point of iron ore is given by equation (3–10) in Chapter 3

$$\begin{aligned} s_I &= D_{avg_I} \times L + SS_I \\ &= 6750000 \times 1 + 16875000 \\ &= 23625000 \text{ ton} \end{aligned}$$

The above calculations can be made by Matlab programming, and amounts of other material can be calculated from the ratio (5–1).

As mentioned earlier, there should be a multi-item inventory model, since there is not just one item. However, we could only focus on the iron ore first. Hence, inventory control is treated as special single-item, and other items can easily be controlled based on their mathematical ratio with the iron ore.

Stock control

In the inventory stores with the iron ore, coke, limestone and coal powder items, the amount of items are displayed. During the week, the manager checks the inventory of items at the stores. It is easy to calculate the amount of ordering coke, limestone and coal powder based on the amount of iron ore ordered, since they are related to the iron ore when the iron ore is checked and ordered.

When the company takes into account fluctuating demand in the changing markets, the company's inventory policy is to satisfy all demand at the time it occurs. If it cannot satisfy demand completely, e.g. the inventory level is almost approaching SS , then an emergency order will be placed at the end of the previous period for the shortage. This order will arrive virtually instantaneously, but at a steep cost for the emergency-order. In the case of low stocks it places an order with available inventory from the supplier. Since the company must guarantee uninterrupted production in the BF process everyday or every week, shortages may occur, and whenever a shortage occurs in advance during review, an emergency order will be placed at the end of the period for the shortage, which selects per unit-time as the shortages cost, but at a steep cost higher than the

normal purchasing cost. Therefore, we consider shortage cost involved in the inventory system.

A brief problem definition

According to Section 1.3, in brief, the main problem is to coordinate the replenishment of orders for raw materials of items in the case company while optimising the inventory level and total cost, and achieving a certain customer service level in inventory management. The main constraints are specified minimum annual total costs for the raw materials of items in the raw materials in SLC and improved ability to counteract the demand fluctuations when the changing markets are considered in the multiple stage steel supply chain. With the experiments, an effective inventory control model will be provided for the raw materials inventory in SLC based on a comparison of the classical inventory model with modern fuzzy logical control combined with the classical (s, S) policy, a comprehensive synthesis for the modelling efforts with the case study, and a final proposed inventory control model of the case.

5.3 Model Formulation and Statement

Based on the inventory cost model and numerical illustration from the previous section, Table 10 presents some values of the parameters of the item (raw materials) obtained.

For the raw materials plant in SLC, the supply chain is as in Figure 25 (a). According to the FICM in Chapter 4, section 4.4.4, and in Figure 18, the fuzzy model is applied for a one stage fuzzy controller (Figure 25(b)), which can use one stage data provided by the case company. With this model, it not only obtains a cost effective inventory, but also tests the fuzzy model to counteract demand fluctuations. The model is executed with input data and output. Several kinds of participants are defined for the purpose of explanation: the BF production, raw materials plant, and supplier. The BF plant is the direct consumer, which places orders for feeding, then uses feeding for the production. The BOF processes, other downstream mills and consumers in the markets are the downstream participants of the supply chain, since this one stage model does not

consider these downstream stages; the data used in the experiment of one stage model just involves the direct consumer– the BF production. The supplier is the most upstream participant of the supply chain. The supplier supplies iron ore, etc. to the raw materials plant, but the supplier does not have its upstream participant. The raw materials plant is the intermediate participant in the supply chain. The raw material plant both places orders from the supplier and delivers orders to feed the BF process.

Table 10. Value of some parameters

Products	Iron ore	coke	limestone	coal powder
Planning horizon (w)	52			
Review process (w)	1			
Lead–time for iron ore (w)	1			
Number of items	4			
Ordering cost (M/t)	5.5	8.4	1.4	4.0
Holding cost (M/w)	14	21	7	10.5
Purchasing cost (M/t)	550(normal)	840	140	400
Shortage (emergency) cost (M/t)	610	870	150	420
Safety Stock (t)	16875000	4050000	1417500	1012500
Re–order point t)	23625000	5670000	1984500	1417500
Average quantity of iron ore (t/a)	351000 000			
Max iron ore (t/w)	7560000			
Min iron ore (t/w)	5737500			
Average weekly demand of iron ore (t/w)	6750000			

Note: M/t: Money/ton; t/w: ton/week; ton/a: ton/annual.

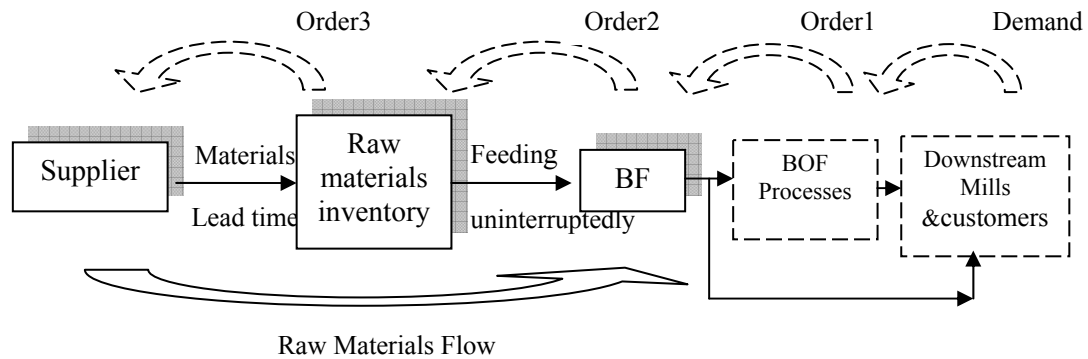

(a)

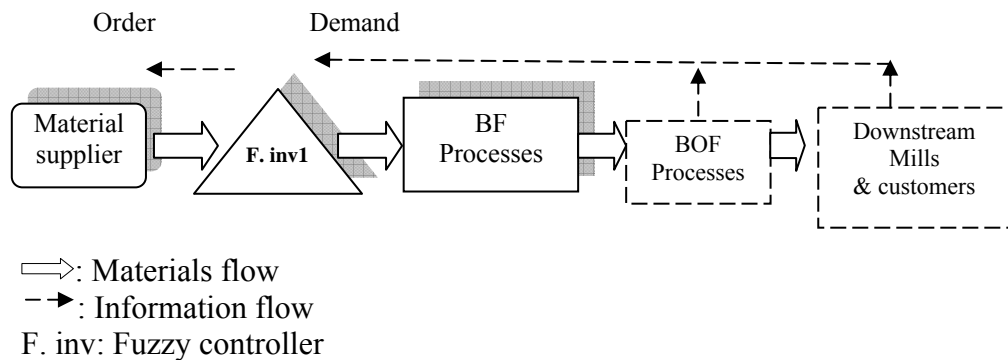

(b)

Figure 25. Raw materials supply chain inventory management in SLC

When considering the two-stage model, there are two types of participants in the demands: the company's own inner steel-making, and the customers of the iron and steel markets. Because of the limitations of current data about the changing markets from the case company, which just provided rough data for both types of participants, this research had to use this data for the demands of end node. Thus, the case study makes the relevance shared data of demand for the second stage fuzzy controller; its fuzzy model is similar to Figure 19.

The inventory will be controlled using an inventory model considering the production guarantee from the raw materials plant in SLC. Two inventory models are considered,

which have been discussed in earlier chapters. With the simulation, the performance of the system is compared using the extension (s, S) inventory policy with a FICM, which have been analysed earlier. Each model statement is as in the following sections.

5.3.1 The Extension (s, S) Policy for Raw Materials Inventory in SLC

This case has been discussed in Chapter 3 and Chapter 4, and now this extension (s, S) policy is applied for the raw material inventory in SLC.

With the discussion in Chapter 3 and the preliminary modelling work in the previous section, an implementation of the extension (s, S) policy was attempted in the model of raw materials inventory in Company SLC, which provided the data for the model from their real environment.

Finally, for the purposes of the experimental design, the study defines $i \in [1, 2, 3 \dots n]$ and $n = 52$. An inventory model based on annual cost also needs to be created; the periodic review case allows the selecting of the period (equal time intervals) such as every week (1 week), it makes easily to simulate model the periodic review case.

With the discussion in Chapter 3, section 5.2.2, and the block diagram model of control system in Figure 26, a cost function model based on extension (s, S) policy was developed, as shown as equation (5-3) in section 5.2.1. Some related constraints will determine if the inventory needs to be placed at period i , the first period to the n th period. From the previous analysis, it is possible to estimate the cost of iron ore inventory first. Then it is easy to obtain other items from their linear relationship, which is shown in (5-1). Therefore, the estimation of iron ore is as follows:

The inventory level for the next period is given by

$$S_{i+1} = f(S_i, D_i, Q_i, L) \quad (5-4)$$

Where

S_i = ending inventory (Order-up-to level) at period i

D_i = demand at period i , it is random seeds or the distributions, including the uniform distribution with the uniform case, the normal, sine wave and exponential distributions with the stochastic model, and imprecise information that consider the fluctuating market.

Q_i = order quantity of at period i

L = lead-time

The lead-time for the inventory level is considered; hence, the inventory level is given by:

$$Inventory_{i+1} = Inventory_i - Demand_{i+1} + Orderquantity_{i-leadtime} \quad (5-5)$$

The model should always check if the forecast inventory will be below s , the rule of (s, S) policy is as follows:

$$\begin{cases} \hat{f}inv < s, & order(Q_i \neq 0) \\ \hat{f}inv \geq s, & don't order(Q_i = 0) \end{cases}$$

$$\hat{f}inv_{i-1} = S_i - (L \times D_{avg}) + \sum_{k=i}^{i+(L-1)} Q_k \quad (5-6)$$

Where

s = re-order point

$\hat{f}inv$ = forecast inventory

$$s = D_{avg} \times L + SS$$

Where

D_{avg} = average demand (day/week/month)

SS = safety stock.

By (5-5), when an order needs to be placed considering the lead-time, the inventory balance equation is then given by:

$$S_{i+1} = S_i - D_{i+1} + Q_{i-L} \quad (5-7)$$

$$Q_i = (s - S_i) + D_i \quad (5-8)$$

$$0 < SS < s$$

$$L, S_i \geq 0;$$

$$i \in [1, n];$$

Assume that an initial inventory level Q_0 can be set, it is noted that Q_0 takes into account the safety stock (SS) and shortages for this inventory system.

Where SS must take into account 2–3 weeks materials feeding to the BF process, then

$$SS = \text{Average weekly demand} \times 2.5 \text{ weeks.} \quad (5-9)$$

The above analysis is for iron ore, other items (coke, limestone, and coal powder) can be obtained from this mathematical relationship as (5–1):

The above model, in spite of its visual simplicity, is a computationally difficult problem. It has a set of constraints and variables in it and involves a random variable demand. The model can be simulated by Matlab. The result from the simulation will be used to compare the result of the FICM in the case.

5.3.2 The FICM for Raw Material Inventory

This proposed model is using a fuzzy logic controller combined with the (s, S) policy. The fundamentals of the fuzzy model in inventory control have been discussed in Chapter 4. The case study now proposes the fuzzy model to find an inventory policy in supply chain management. The result from the simulation will be used to assist in the building of an inventory model in the raw materials plant of SLC.

The block diagram model of the inventory control is shown in Figure 26, which shows that the (s, S) policy will decide when an order needs to be placed, and the fuzzy control method will evaluate the order quantity.

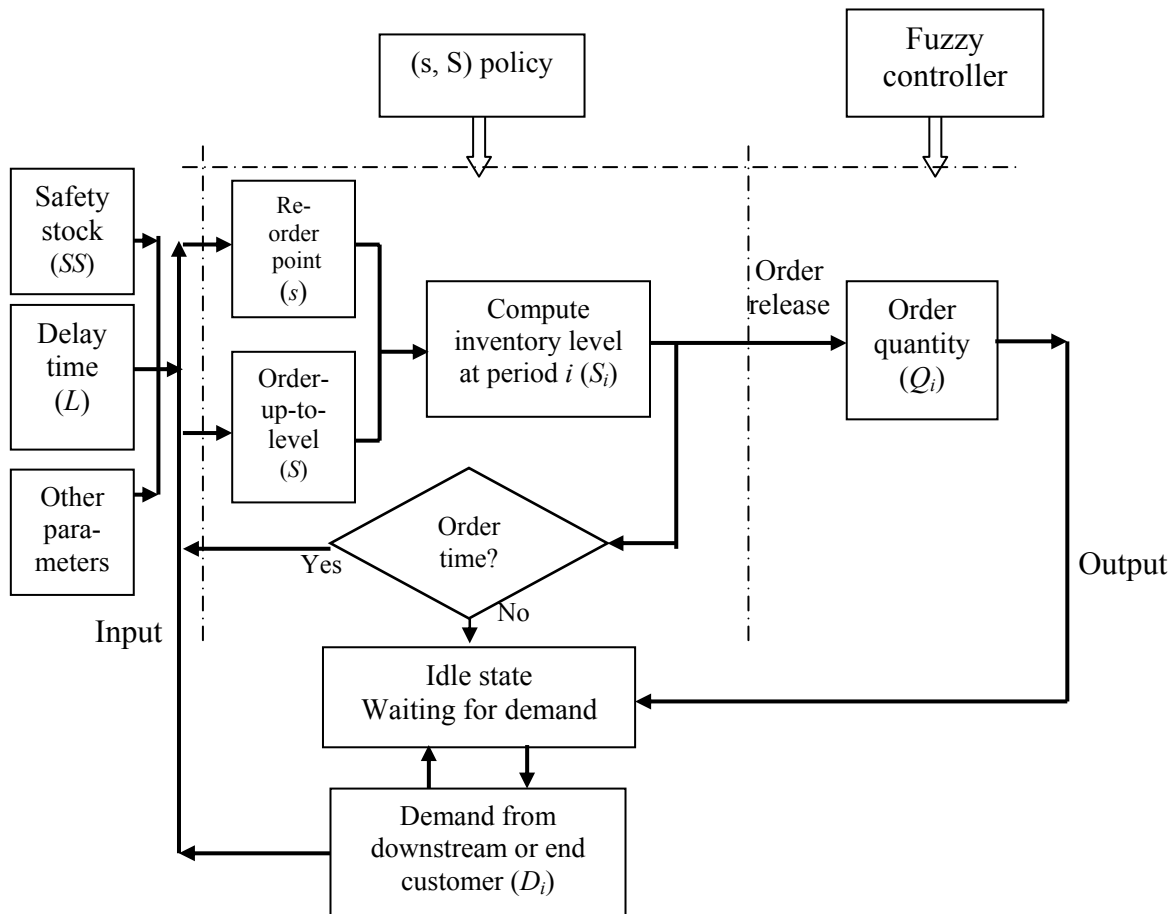

Figure 26. Overview of Fuzzy inventory modelling approach

The FICM will take into consideration the fuzzy logic controller together with the (s, S) policy. With this model, several aspects of the system were handled in the same way as in the crisp runs, which used the extension (s, S) policy as in the previous section. With this model, the (s, S) policy will decide when an order needs to be placed, and the fuzzy control will evaluate the order quantity. The order quantity, emergency order, forecast inventory, initialisation, etc. were all calculated in the same way as the crisp runs. The fuzzy controller will count the order quantity when an order was placed.

According to the application procedures in Chapter 4, several procedures are taken into account for fuzzy model design according to the detailed sections 4.3 and 4.4, including fuzzification, fuzzy control rules, fuzzy operators and defuzzification.

In summary, a simulator-based model has been presented. To test it in this preliminary work, an inventory system with SLC was considered and simulated. The adaptation idea was adapted in two models, which are the extension (s, S) policy and a proposed fuzzy model. The optimal policies were determined using the extension (s, S) policy for determining the ordering time and were combined with fuzzy logic for evaluating the order quantity. Both were subsequently tested on the Matlab, and then for running and results, giving a comparison and alternative approach. With the Matlab, the experiment work in the following chapter will show (1) the proposed FICM based on a fuzzy logic controller combined with the (s, S) policy provides improved performance in cost and inventory level. (2) The FICM improve the inventory control in a stochastic demand case and demand with imprecise fluctuation case. And (3) The FICM improves the ability to counteract the demand-magnification effect when demand fluctuations are considered in a multiple stages supply-demand network?

6 NUMERICAL EXPERIMENTS AND DISCUSSION

6.1 Overview

The alternative inventory control model was produced by comparing the performance of the proposed fuzzy model with classical inventory policy for SLC, applying two inventory control models to the case study, namely the single stage and two-stage supply chain cases. By doing these experiments the role of inventories in supply chain and raw materials inventories could be better understood in stochastic demand cases. Some assumptions were also made for the cases so that the problem can be solved using the model discussed earlier. Several runs were tried for the test cases with different demand distributions and it was noted that almost the same solution was obtained. This suggests stable solutions for SLC, with, however, no guarantee that they are optimal for each demand distribution.

6.2 Experiment Details

The simulation design, which is based on discussion and information about the iron and steel industry as in the previous chapters provided more a realistic cost structure and demand characteristics involved in a multiple-item, single-stage or two-stage supply chain consisting of one or two intermediate participants, suppliers with price breaks of 3 levels and downstream consumer (BF process, BOF or iron and steel market).

The company had a capacitated facility, feeding multiple-items for the production process. No explicit lead-times are considered here, since a constant lead-time would not change the conclusion in any way. However, the actual lead-time, as a result of insufficient capacity, would be implicitly determined in the raw materials re-order point and demand forecast. The customer demands for the raw materials plant are created by the demand with historical data from the company SLC. Because of the limitations of the data from the case company, the several types of demand inputs used in the case

study will be generated by a series of almost uniform demands over time provided by the company. To test the single FICM, these demands will contain uniform, normal, sine wave and exponential demand distribution. To test the multiple stage FICM, the random seeds based on the data from the case company will be as demand input in the two-stage FICM in SDN, as the company just provided the data for two stages. The production process replenished items from the raw materials inventory by placing orders directly to the raw materials inventory. As a result, the raw materials plant needed to feed items to the production (BF process and BOF process) continuously. The lead-time and price breaks have to be taken into account when the company places an order, which was discussed in the previous chapter.

The simulation procedure consisted of three phases, to be discussed below.

6.2.1 Assumptions

Before running the simulation model, the first phase of the procedure is developing some assumptions in the method to simplify the problems, as follows:

1. Demand is D_i . In the single stage model, it was set to several types of demand, including the uniform distribution with the uniform case, the normal, sine wave and exponential distributions with the stochastic model, and imprecise information that consider the fluctuating iron and steel market. In the two-stage model, it was set to the random seeds based on the data from the case company and fluctuating iron and steel market. All these are applied with historical data from SLC and corresponding demand generator given in Matlab.
2. The iron ore will be the single item for the cost function of extension (s, S) policy in equation (5-3); the other items considered are own holding cost, ordering cost, emergency order cost and purchasing cost.
3. The values of the related parameters are directly obtained or calculated by actual data from SLC.

4. The suppliers are reliable suppliers with price breaks on 3 levels for iron ore.
5. About lead-time: for this case study, lead-time is the time between the raw materials plant placing an order and receiving (L weeks). However, no explicit lead-times are considered from the raw materials plant to its downstream customer (production process).
6. Initialise inventory: to cover the first delay weeks and safe purpose, initialise inventory is set to $SS \times (1+5\%)$, which can maintain the BF running and avoid the risk of emergency-order, and $SS = \text{Average weekly demand} \times 2.5$ weeks so as to cover production for more than 2–3 weeks (2.5 weeks). But for sine wave demand distribution, we set Initialise inventory = Average weekly demand \times 4 weeks since the beginning ratio is sharp and it needs the higher initialise inventory.
7. The order quantity up to lead-time is set at zero during the first lead-time week.
8. The batch of demand size is considered unlimited.

6.2.2 Generating the Demand Distributions

The second phase of the simulation is generating demands for the raw materials inventory management of the company. As stated earlier, the company has been using only uniform demand in its inventory policy, which is quite common in the iron and steel industry. However, concerning fluctuating demand when the company is developing as an iron and steel co-operator, the demand for the raw materials inventory is not only a uniform model. In the case study, with the several distributions, this research applies stochastic demand and imprecise information with the demand fluctuations in the changing markets. Since a powerful feature of the Matlab Statistical Toolbox is that one can easily calculate and plot the density and distribution functions for many distributions and also simulate random samples from these distributions, the

demand distributions can be generated by a corresponding demand generator given in Matlab and historical data from SLC to imitate demands, which include the uniform, normal, exponential and sine distributions. The alternative inventory control model can be adequate for the different demand distributions for the stochastic case and imprecise information case caused by changing markets. Since the demand data obtained from SLC was incomplete for all types of demand distributions, and since the generated demands should be subject to the data that has been obtained from SLC, therefore, when the demands were generated, these generated demands should have the same interaction area with practical annual demand (approximate uniform demand) provided by the case company. For distribution generating, the Statistical Toolbox disintegrates the total annual amount by the company for demand into different distributions that the case study needs, then it adds white noise to each one to represent the fluctuations in each demand. The Statistics Toolbox function “PDF” is used to return the different probability density function at the values in x (52 weeks). Since the scope for the actual iron and steel market changing over time is soft, and μ and σ were selected for normal distribution, mean–scale parameter γ was selected for exponential to be soft values (e.g. $\mu=26$, $\sigma =12$ in normal distribution, and $\gamma=15$ in exponential). Moreover, when the demand considers seasonal distribution to occur, the sine distribution is also generated by Matlab. All these probability density functions (PDF) should cover the same interaction area for the actual annual amount given by the company. These demand distributions are generated in detail as follows.

Uniform distribution: is used to describe random occurrences with several possible outcomes, each of which is equally likely. The programming shows that the uniform distribution has the random number generator

$$a + (b-a) \times \text{rand} ()$$

Where: $a < b$, and a and b represent the minimum and maximum bounds of the distribution, respectively, which we can collect from the historical data from SLC.

In the case in this industry, the running of the simulation is for 52 weeks, which means the set of time is 52, and interval time is one week since we use the weekly demand. Hence it could create random numbers for 52 from the random number generator, with their parameters associated with the different distributions. Matlab random number generator puts 52 equally spaced points in the range 1 to 52 into x for those distributions, $x = 1:1:52$ and evaluates the probability density function (PDF) at the points in the data set x , respectively. Finally, it puts the results in each data set, which covers the same interaction–area for the actual annual amount given by the company.

Normal distribution: applications include quantities that are the sum of a large number of other quantities (by virtue of the central limit theorem) and errors of various types.

$$f(x) = \left\{ \frac{1}{\sqrt{2\pi\sigma^2}} e^{-(x-\mu)^2 / (2\sigma^2)} \quad \text{for all real numbers } x \right\}$$

Where : $\sigma > 0$, Mean = μ Variance : σ^2

Note : $N(\mu, \sigma^2) = N(0, 1)$ is the standard normal distribution

Sine wave distribution: is used for the seasonal events that occur in an interval of time when the events are occurring at some season. Also used for the number of items demanded from an inventory.

$$f(x) = \sin(x)$$

Exponential distribution: is often used to model inter–arrival times of "customers" to a system that occurs at a constant rate.

$$f(x) = \begin{cases} \frac{1}{\gamma} e^{-x/\gamma} & \text{if } x \geq 0 \\ 0 & \text{otherwise} \end{cases}$$

where : mean - scale parameter $\gamma > 0$

Mean = μ (rate = $1/\gamma$) Variance = γ^2

The above four probability density functions (*PDF*) represent a set of different demand distributions related to the changing market, including the typical demand sort. When the simulation was running, and the demand generator by Matlab was set to start, the different demand distributions were used for the case study to generate their demand so that we can select any one of them in the case study.

In the two-stage model, since this research focus is on the proposed fuzzy model to cope with the demand fluctuations, the demand is just using the random seeds based on the data from the case company, plus the noise as its demand input in the two-stage FICM.

In brief, the above demand distributions were used in the case study, which include the uniform, normal, exponential and sine distributions with historical data given by the company and created by Matlab / Statistical Toolbox, and then adding the fluctuation.

6.2.3 Decisions on Ordering Raw Materials

The planning horizon of the inventory model for the company is 52 weeks, and the period was set to one week. Based on the demand forecasts, the company decided when and how many units to order from the supplier during the planning horizon by using the extension (s, S) policy and the fuzzy control combined with (s, S) policy.

Since the period interval is one week, one week later it needs to calculate the forecast inventory for maintaining uninterrupted BF running. Orders for raw materials could be updated based on the extension (s, S) policy, which was discussed earlier. For example, if L is the lead-time, when the company must place an order, it must place the order L

weeks in advance based on forecasts, whereas the supplier must deliver the raw materials L weeks later, and this delivery would arrive at the raw materials plant of company L weeks later due to the transportation lead-time. This procedure can take into account the forecast inventory level, that is why we considered the forecast inventory level involving the order quantity lead-time (L) before. Then, at the end of the week, the actual customer (production factory) demand was realized. The raw materials plant filled the customer's order by on-hand inventory and any shortages or emergency-order forecast would become backorders.

This process was repeated until ordering, production and delivery decisions were developed for all 52 weeks. After the entire simulation run was completed, all cost items were calculated for the raw material plant. The total cost would be used to measure the performance of the supply chain. As indicated earlier, all performance measures were calculated only with the data from weeks 1 to 52.

6.2.4 Testing with Simulation

Model parameters: A major advantage of using computer simulation models is to allow many parameters to vary in different simulation settings. There were three major groups of model parameters in this simulation experiment. The first group was “environmental factors” or “operating conditions” of the systems, which included demand distributions (uniform, normal, sine wave and exponential) and price breaks (3 levels). The second group was the decision parameters, which can calculate the inventory forecasting and, if needed, order and order quantity, including average weekly demand per year (tons/week), inventory lead-time (weeks), safety stock (tons), maximum weekly demand per year (tons), minimum weekly demand per year (tons), and so on. The third group was the cost structural parameters, which can calculate the maximum annual cost of the items, including ordering cost for placing an order (Yuan/order), holding cost per unit inventory per unit time per year (Yuan/ton/week), shortage or emergency-order cost (Yuan/unit), purchasing cost (Yuan/ ton), review period (week), average inventory quantity, number of times of ordering, emergency-order times per year, the total length of the planning horizon, and so on.

As indicated earlier, all demand distributions (the uniform, normal, sine wave and exponential distributions) representing the different commonly demand sorts were used in this research. The price breaks of iron ore referred to how much the different purchase price was relative to the order quantity, and was considered in the different available selections by the total optimum cost. Three levels of price level, i.e. “normal”, “medium” and “high” were given by the company. They corresponded to the discount percents of 0%, 5% and 10%, respectively. The cost structural parameters were also given by the company. As those related formulae have been indicated in the previous chapter, we omit them.

To investigate multiple FICM to counteract demand fluctuations in the case study when the fluctuating demand is considered, an inventory model has also been built with a two-stage fuzzy controller in the case study when the two-inventory node could not have information sharing. With this model, the first level controller between is next to the end customer (in the case study: BOF or changing markets), and the second level controller BF and raw materials inventory is near to the supplier (in the case study: raw materials plant). The demand of the first inventory controller is from the end customer, and the demand of the second inventory controller is from the order of the first inventory controller (Figure 27).

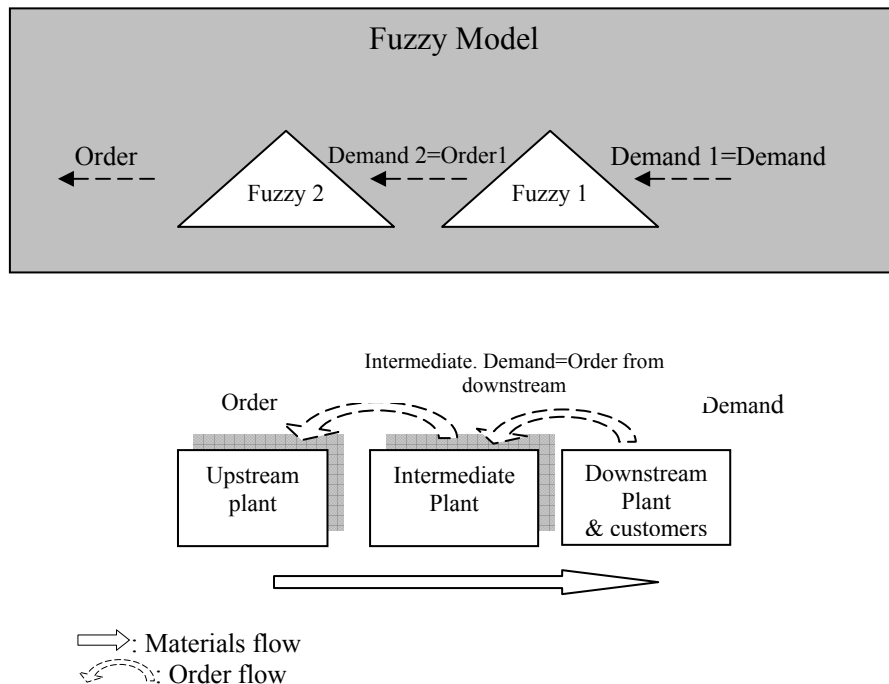

Figure 27. Two-stage FICM in the case study

6.2.5 Performance Measures

The following criteria were used as the dependent variables of the experimental design to measure the supply chain performance.

1. Total annual inventory cost for (CTU): sum of the iron ore, coke, and limestone and coal powder.
2. Minimal annual inventory costs of each item ($CT_k, k \in (1, j)$): sum of the ordering cost, holding cost (for backorder deliveries, if any), purchasing cost, and shortage cost (forecast), if any. They include the iron ore, coke, limestone, and coal powder.
3. Order times (OT_k): total number of order times for the total length of the planning horizon of each raw material.
4. $OP (= \frac{OT_k}{n} \times 100\%)$: annual order percentage for the total length of the planning horizon of raw material. $N = 52$.
5. ST : total number of shortage or emergency-order times for the total length of the planning horizon of raw material.
6. $SP (= \frac{ST_k}{n} \times 100\%)$: annual emergency-order percentage for the total length of the planning horizon of each raw material.
7. Fuzzy effect for cost (FP): percentage of decrease for CTU using the fuzzy model from extension (s, S) policy. $FP = \frac{CTU_{(s,S)} - CTU_{Fuzzy}}{CTU_{Fuzzy}}$. Sometimes it might be negative if the fuzzy model becomes worse than the classical policy.
8. Annual average inventory (AAI_k): annual average inventory of the items, which are the mean of the inventory levels.
9. Fuzzy effect for inventory level ($AAIP$): percentage of decrease for AAI_k using the fuzzy model from extension (s, S) policy. $AAIP = \frac{AAI_{(s,S)} - AAI_{Fuzzy}}{AAI_{Fuzzy}}$.

10. Service level ($r\%$): percentage of inventory level holding in linear feet met from safety stock (SS). $r\% = 1 - SP(\%)$.
11. Standard deviation of demand distribution (Std_D).
12. Standard deviation of order quantity (Std_Q).
13. Standard deviation of inventory level (Std_S).
14. Damping effect to demand fluctuations ($Damp$): $Damp = \frac{Std_S - Std_D}{Std_D}$
15. Demand–magnification effect = $\frac{c_{out}}{c_{in}}$
 $(c_{in} = \frac{Std_D_{in}(t, t+T)}{Mean_D_{in}(t, t+T)}, c_{out} = \frac{Std_D_{out}(t, t+T)}{Mean_D_{out}(t, t+T)})$

The tables of results used the above criteria. Moreover, the related diagrams and graphs are shown in the next section. For example, the comparison curve of inventory level between the fuzzy model and the extension (s, S) policy in different demand distributions, the histogram of average inventory using the two models, and so on. The simulation program was tested for the calculation of total cost of each item as well as comparing the total cost with two different inventory models.

6.3 Results from the Simulation

According to the discussion in the previous chapters, and the modelling and simulation of the case study in the last section, this section presents tables and graphical representations of the results and discusses the insights gained from each of the experiments. First, the results from the simulation are summarized. Then the results will be discussed in detail. In the discussions, the merit is the total cost, inventory level and demand–magnification effect, and that result is in the comparison between the classical model and proposed fuzzy model. For each combination of the performance criteria (CTU , AAI , OT , ST , FP , $r\%$, $AAIP$, ω , $Damp$, etc.) simulation runs were conducted to compare the effects of the two inventory models. Since the planning horizon was 52 weeks, a total of 52 simulation runs were conducted. The output from the simulation

experiments was analyzed based on the performances. By doing these experiments we are better able to understand the improvement of fuzzy control combined with (s, S) policy and raw materials inventories in different demand distributions.

To meet the assumptions of different demand distributions, lead-time and initialisation inventory, etc., the alternative effective inventory control model is produced by comparing the performance of the fuzzy with classical inventory model, and the experiment was suggested by comparison of tables and diagrams based on the results of the simulation. The first case is generated as uniform demand distribution, the second case as normal demand distribution, the third case is exponential and fourth case sine (or seasonal). Also, the case of random seeds based on the data from the case company is for the two-stage model. All cases are generated by distribution function, and 10% white noise added as actual demand. For counteraction to demand fluctuations, the damping effect of inventory to heavily fluctuating demand has also been shown in a related graph, which will demonstrate that the proposed FICM has much damped oscillatory response to demand fluctuations.

Several simulations were listed for the experiment design and the simulation results in Tables 11–18 show the significance of the FICM in terms of the total inventory cost (*CTU*), average inventory level (*AAI*), order times (*OT*) or its percentage (*OP*), emergency-order times (*ST*) or its percentage (*SP*), and service level (*r%*). Fuzzy effect *FP* and *AAIP* have significant effects on all performance measures with the different demand distributions; the score of demand-magnification effect (ω) and damping of inventory (*damp*) to fluctuating demand with random seeds by FICM are shown in Tables 19–21. Moreover, Figures 28–35 show the same significant effects as well. Thus, this deserves more detailed analysis of the variables involved.

Table 11. Annual cost, order times, service level and comparison – uniform PDF

Series	CTU ($\times 10^{11}$)		FP (%)	OT or Ave. OP (%)		ST or SP (%)		r %	
	Fuzzy	(s, S)	Comp.	Fuzzy	(s, S)	Fuzzy	(s, S)	Fuzzy	(s, S)
1	1.9033	2.8668	50.62	16	25	1/1.9%	7/13.5%	98.1	86.5
2	1.8949	2.8508	50.44	16	24	1/1.9%	8/15.4%	98.1	84.6
3	1.9598	2.8595	45.91	16	24	1/1.9%	8/15.4%	98.1	84.6
4	1.9192	2.8740	49.75	16	24	1/1.9%	8/15.4%	98.1	84.6
5	1.9094	2.8520	47.37	16	25	1/1.9%	7/13.5%	98.1	86.5
6	1.9263	2.8712	49.55	16	24	1/1.9%	7/15.4%	98.1	84.6
Ave.	1.9175	2.8628	49.21	30.77%	46.15%	1.9%	15.38%	98.1	84.6

Note: Ave.: Average; Comp.: Comparison

Table 12. Annual cost, order times, service level and comparison – normal PDF

Series	CTU ($\times 10^{11}$)		FP (%)	OT or OP (%)		ST or SP (%)		r %	
	Fuzzy	(s, S)	Comp.	Fuzzy	s, S	Fuzzy	s, S	Fuzzy	s, S
1	2.2115	2.8293	27.94	10	13	3/5.8%	8/15.4%	94.2	84.6
2	2.2132	2.7939	26.24	10	13	3/5.8%	8/15.4%	94.2	84.6
3	2.1903	2.7225	24.23	11	13	4/7.7%	8/15.4%	92.3	84.6
4	2.0811	2.8049	34.78	10	13	4/7.7%	8/15.4%	94.2	84.6
5	2.0177	2.7812	37.84	9	13	3/5.8%	8/17.3%	94.2	84.6
6	2.0701	2.7806	34.32	10	13	4/7.7%	8/15.4%	94.2	84.6
Ave.	2.0506	2.7747	35.32	19.32%	25%	6.3%	15.8%	93.7	84.6

Table 13. Annual cost, order times, service level and comparison – sine distribution

Series	CTU ($\times 10^{11}$)		FP (%)	OT or OP (%)		ST or SP (%)		r %	
	Fuzzy	(s, S)	Comp.	Fuzzy	(s, S)	Fuzzy	(s, S)	Fuzzy	(s, S)
1	1.9889	3.0664	54.18	16	25	1/1.9%	6/11.5%	98.1	88.5
2	1.9225	3.0000	56.04	15	26	1/1.9%	6/11.4%	98.1	88.6
3	1.9533	3.0082	54.00	16	25	1/1.9%	6/11.4%	98.1	84.6
4	1.9859	3.0696	54.57	16	25	1/1.9%	7/13.4%	98.1	86.5
5	1.9130	3.0063	57.15	16	25	1/1.9%	6/11.4%	98.1	84.6
6	1.9821	3.0700	54.89	16	25	1/1.9%	6/11.4%	98.1	84.6
Ave.	1.9488	3.0433	55.24	29.33%	48.56%	1.9%	11.7%	98.1	84.3

Table 14. Annual cost, order times, service level and comparison–exponential PDF

Series	CTU ($\times 10^{11}$)		FP (%)	OT or OP (%)		ST or SP (%)		r %	
	Fuzzy	(s, S)	Comp.	Fuzzy	s, S	Fuzzy	s, S	Fuzzy	s, S
1	2.0252	2.5326	29.99	11	24	5/9.6%	6/11.5%	90.4	88.5
2	2.0329	2.6283	29.29	11	24	5/9.6%	6/11.5%	90.4	88.5
3	2.0400	2.6314	28.99	11	24	5/9.6%	6/11.5%	90.4	88.5
4	2.0877	2.7207	30.32	12	24	3/5.8%	6/11.5%	94.2	88.5
5	2.0280	2.5858	27.51	11	23	5/9.6%	6/11.5%	90.4	88.5
6	2.0814	2.7183	30.60	11	24	4/7.7%	6/11.5%	92.3	88.5
Ave.	2.0315	2.5945	28.94	21.15%	46.15%	9.5%	11.5%	91.5	88.5

Table 15. Average inventory cost and its improvement– uniform PDF

Series	AAI ($\times 10^5$)		AAIP (%)
	Fuzzy	(s, S)	
1	3.6695	4.0698	10.91
2	3.6407	4.1718	14.49
3	3.7760	4.1111	8.88
4	3.7461	4.1085	9.35
5	3.6433	4.0598	11.67
6	3.5713	4.0578	13.62
Ave.	3.6745	4.0965	11.48

Table 16. Average inventory and its improvement –normal PDF ($\sigma=12, \mu=26$)

Series	AAI ($\times 10^5$)		AAIP (%)
	Fuzzy	(s, S)	
1	4.4327	4.9843	12.44
2	4.4366	4.8962	10.36
3	4.3811	4.7348	8.07
4	4.0173	4.8887	21.69
5	3.1414	3.7549	19.54
6	3.0762	3.8281	24.44
Ave.	3.9142	4.5145	15.34

Table 17. Average inventory and its improvement –sine distribution

Series	AAI ($\times 10^5$)		AAIP (%)
	Fuzzy	(s, S)	
1	3.0380	3.6382	19.76
2	3.1322	3.6977	18.06
3	3.2978	3.6409	10.04
4	3.1253	3.6436	16.59
5	3.1917	3.6296	13.72
6	3.1637	3.7037	17.07
Ave.	3.1581	3.6590	15.87

Table 18. Average inventory and its improvement –exponential PDF ($\gamma=15$)

Series	AAI ($\times 10^5$)		AAIP (%)
	Fuzzy	(s, S)	
1	4.0503	4.1931	3.52
2	4.0685	4.1976	3.17
3	4.0829	4.1984	2.83
4	4.0551	4.1969	3.50
5	3.6922	3.8048	3.05
6	3.7060	3.8097	2.80
Ave.	4.0642	4.1965	3.25

Table 19. Performance measures of one stage FICM

Fluc. (%)	AAIP (%)	FP (%)	Std_D ($\times 10^4$)	Std_S ($\times 10^4$)		Std_Q ($\times 10^4$)		Damp		Bullwhip(ω)	
				s, S	Fuzzy	s, S	Fuzzy	s, S	Fuzzy	s, S	Fuzzy
30	6.49	10.72	0.62152	7.4445	7.3009	5.7904	2.6706	10.9780	10.7469	9.1023	4.1394
50	7.72	14.50	0.86444	7.2667	7.1636	5.2814	1.4169	7.4062	7.2870	5.9526	1.6291
60	10.06	4.51	1.0449	8.2672	7.3893	6.1658	1.6878	6.9118	6.0716	5.8704	1.5646
70	7.7	5.84	1.1406	8.3783	7.2170	6.3193	1.3781	6.3455	5.3273	5.6802	1.2465
Comp.	positive	positive		higher	lower	lower	higher	higher	lower	higher	lower

Note: Fluc.: Fluctuation, Comp.: Comparison

Table 20. Performance measures of two-stage FICM

<i>Fluc.</i> (%)	Std_D ($\times 10^4$)		Std_S ($\times 10^4$)		Std_Q ($\times 10^4$)		Damp	
	1st	2nd	1st	2nd	1st	2nd	Fuzzy1	Fuzzy2
30	0.63253	2.3589	4.9297	3.5516	8.1029	4.6440	6.7936	0.5056
50	1.0943	2.4438	3.3663	5.0167	8.2178	4.1501	3.5843	0.3775
60	1.2441	2.1665	5.2181	3.6408	8.2351	4.3465	3.1942	0.6805
70	1.4015	2.4621	5.2140	3.4482	8.3216	4.5733	2.7203	0.4005
Comp.					higher	lower	higher	lower

Table 21. Demand-magnification effect measures of two-stage inventory model

<i>Fluc.</i> (%)	Each stage demand-magnification effect				Total demand-magnification effect(ω_t)	
	1 st (ω_1)		2 nd (ω_2)		Classical	Fuzzy
	Classical1	Fuzzy1	Classical2	Fuzzy2		
30	9.4192	3.8868	1.3832	0.5434	17.3701	7.5462
50	5.5207	2.2970	1.2883	0.6962	9.0670	5.4464
60	5.3336	1.8430	1.2824	0.4030	8.7719	2.9673
70	4.7126	1.6509	1.3077	0.3895	7.3410	2.3620
Comp.	higher	lower	higher	lower	Higher	lower

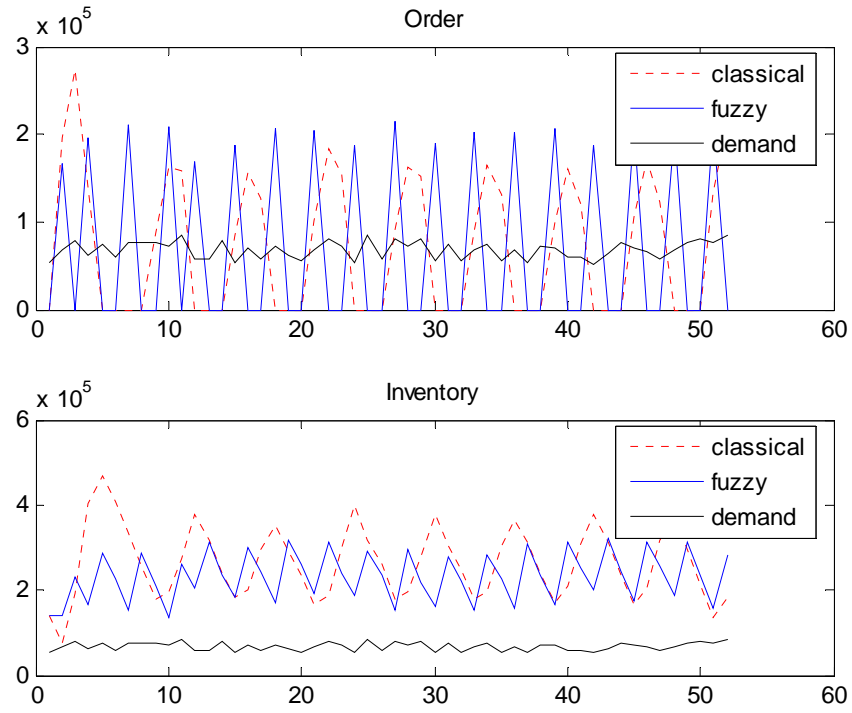

Figure 28 (a)

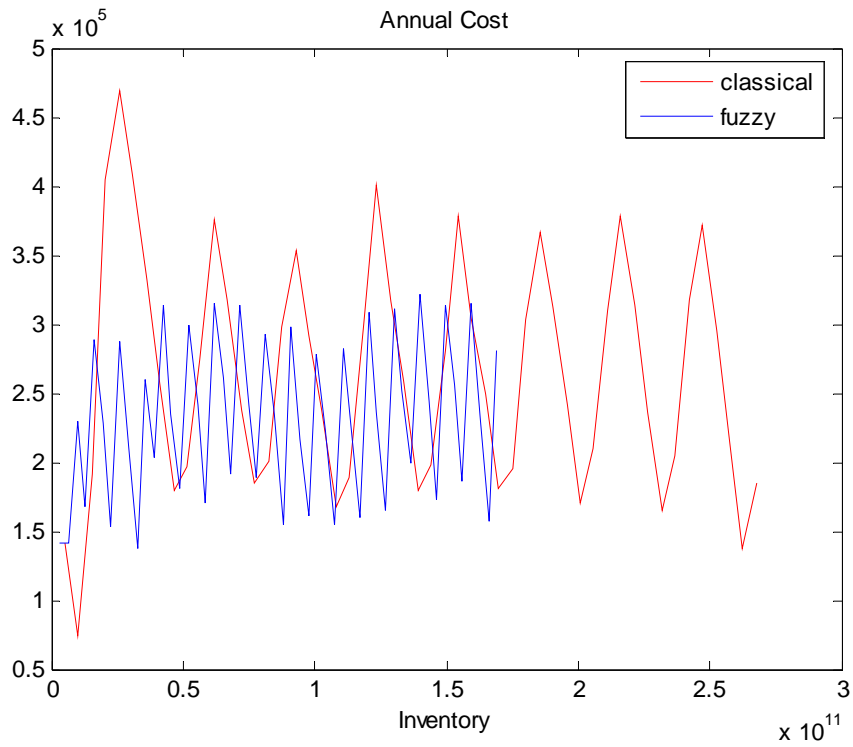

Figure 28 (b)

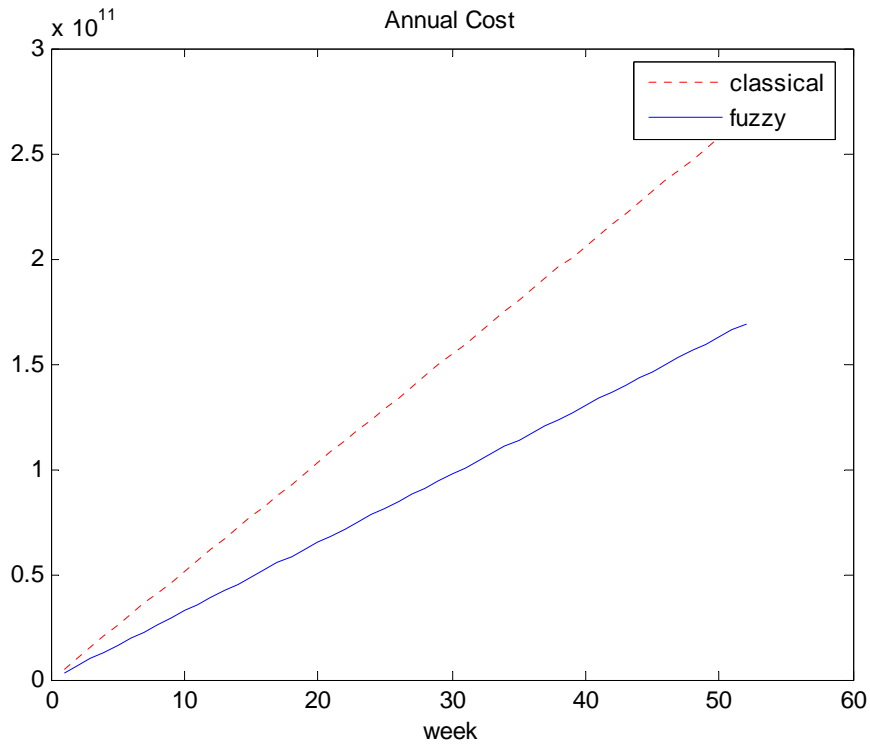

Figure 28 (c)

Figure 28. Comparison of fuzzy with classical model– uniform demand distribution

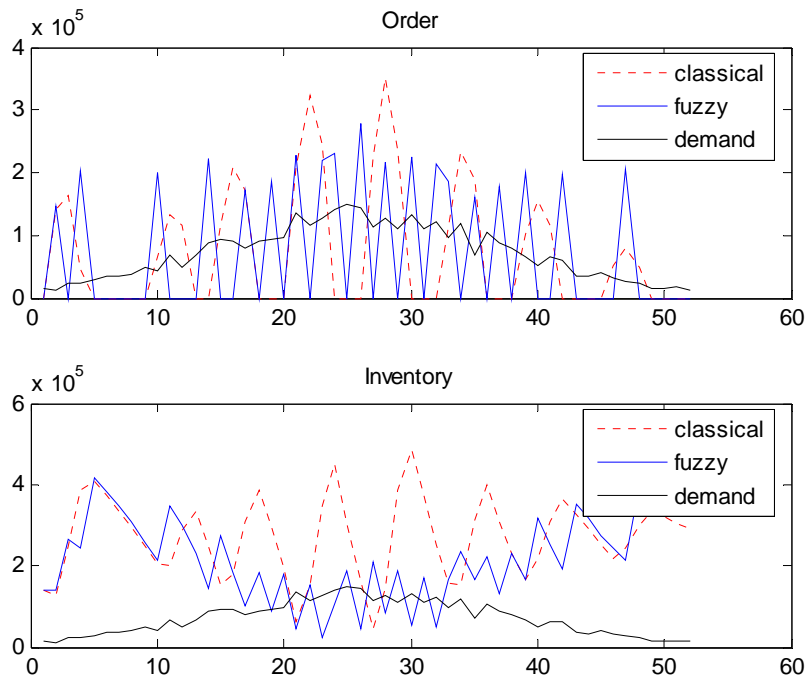

Figure 29 (a)

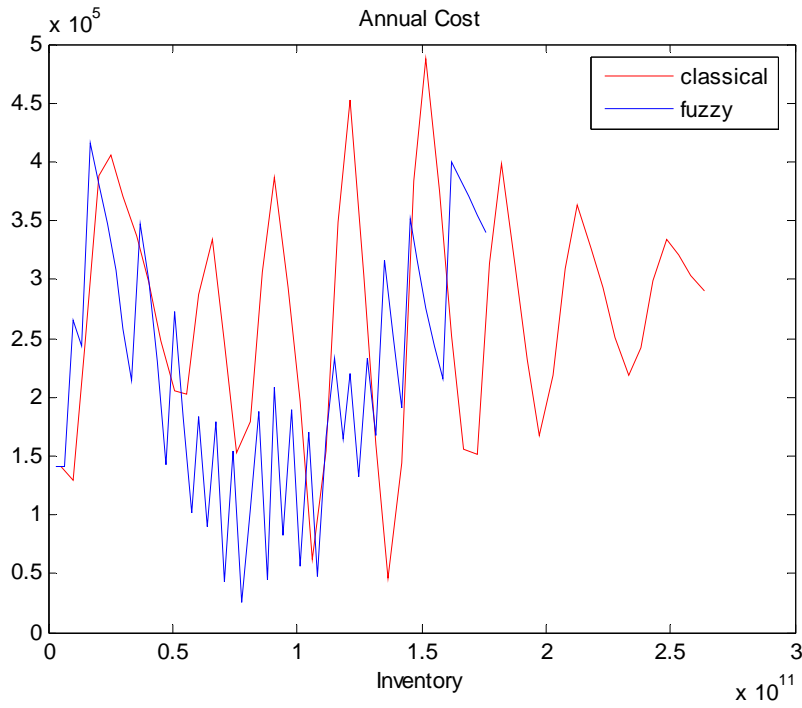

Figure 29 (b)

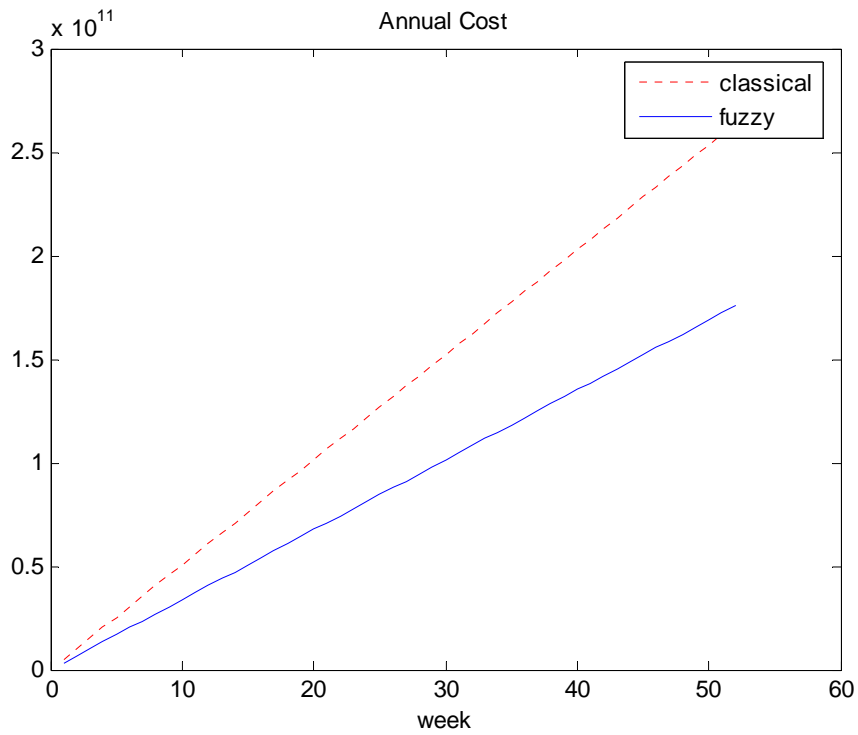

Figure 29 (c)

Figure 29. Comparison of fuzzy with classical model– normal demand distribution
 ($\sigma = 12, \mu = 26$)

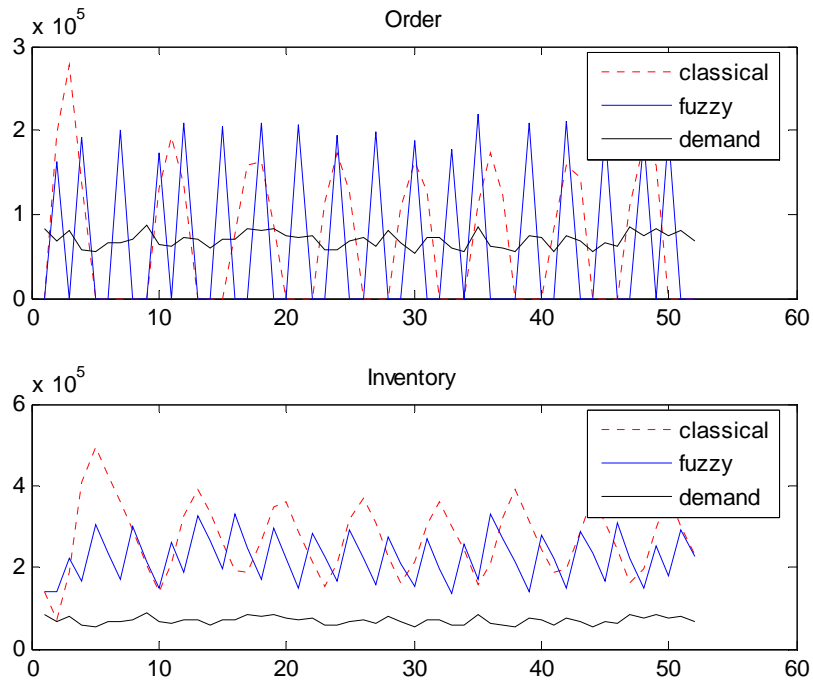

Figure 30 (a)

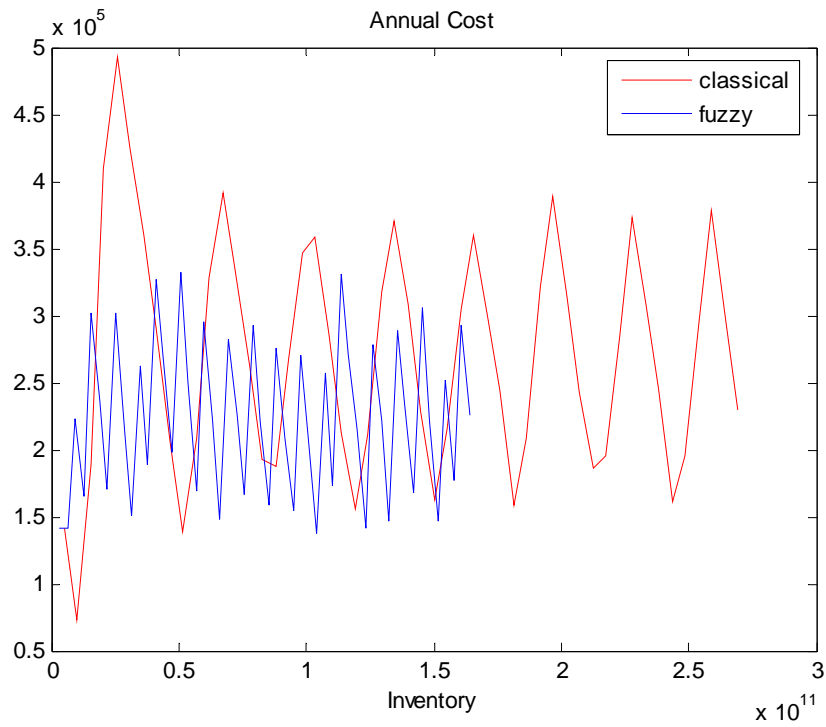

Figure 30 (b)

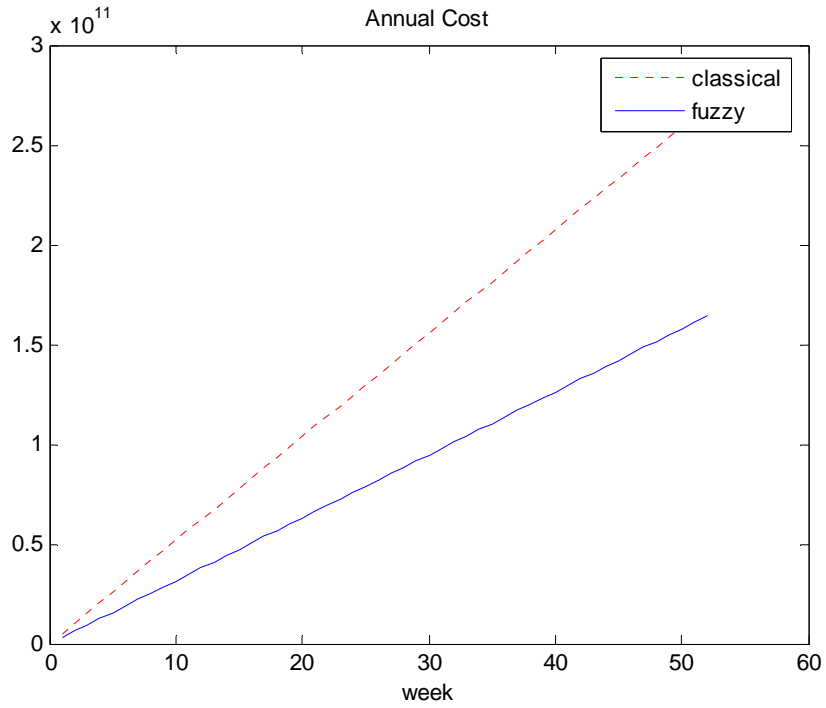

Figure 30 (c)

Figure 30. Comparison of fuzzy with classical model– sine wave demand

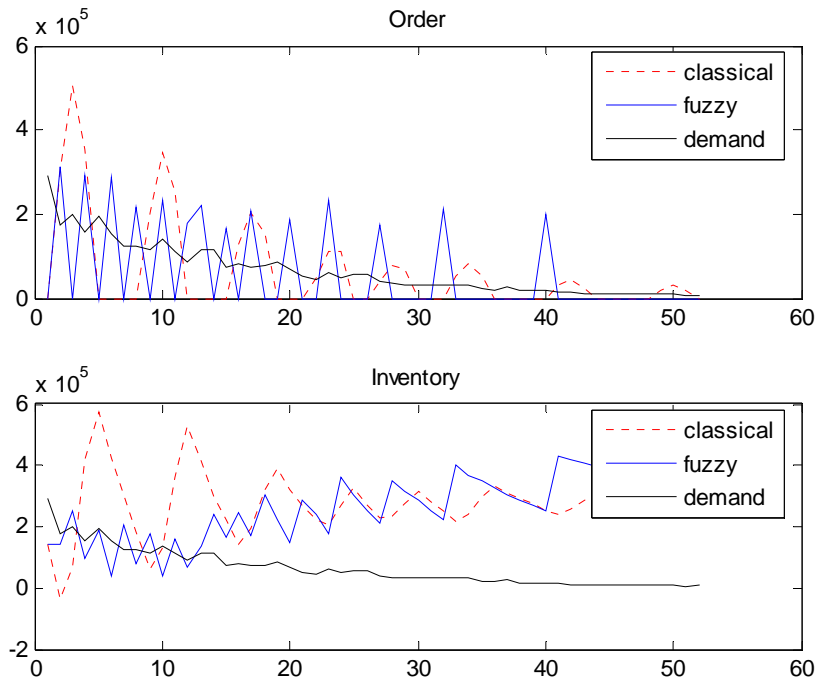

Figure 31 (a)

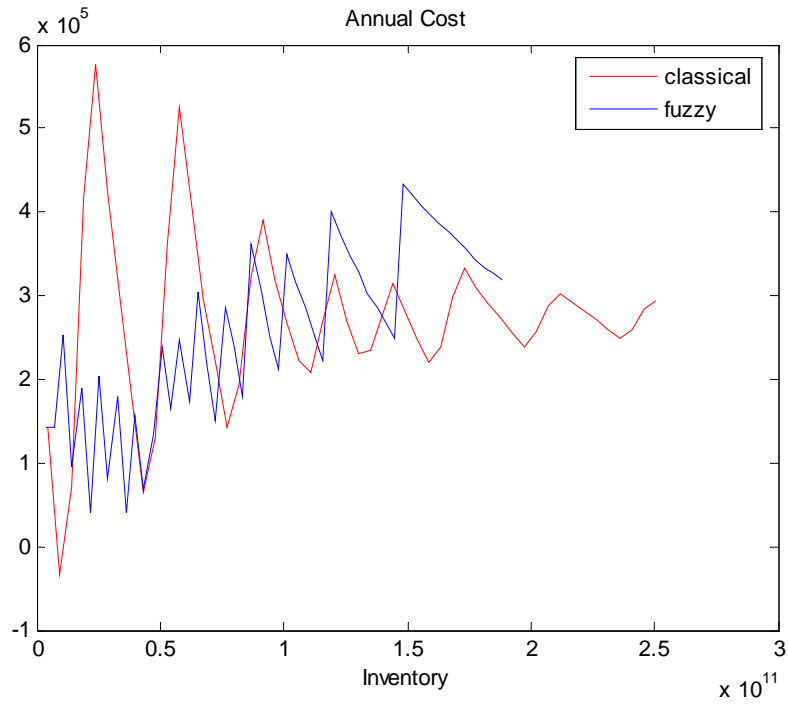

Figure 31 (b)

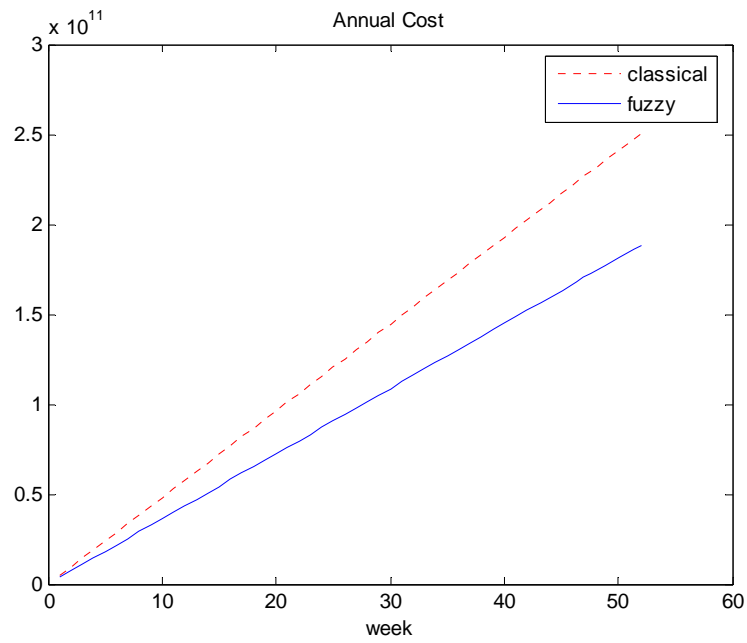

Figure 31 (c)

Figure 31. Comparison of fuzzy with classical model– exponential demand distribution ($\gamma=15$)

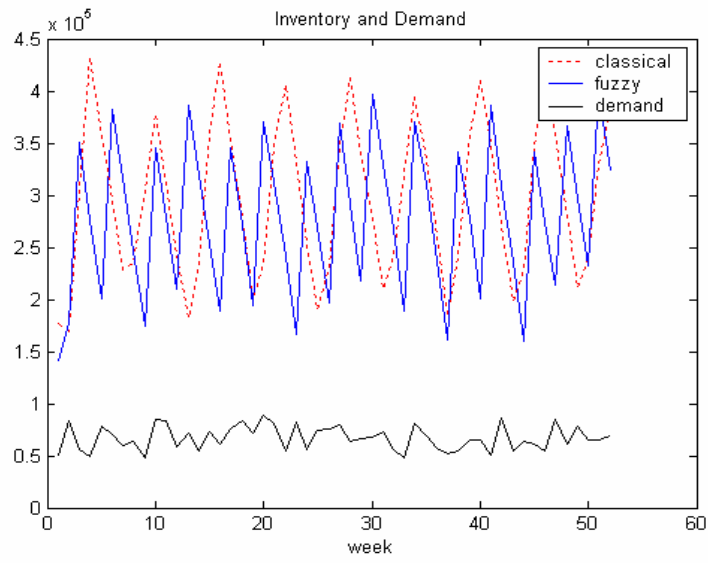

Figure 32 (a): Response of inventory (50% demand fluctuations).

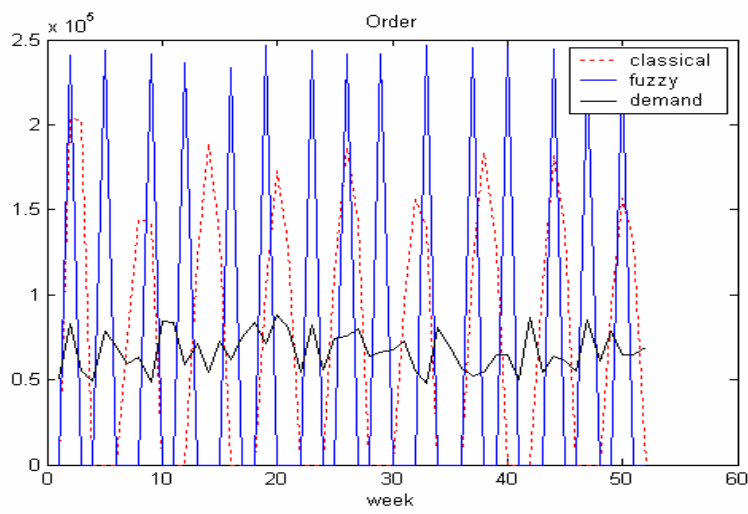

Figure 32 (b): Response of order (50% demand fluctuations).

Figure 32. Response of one-stage model to fluctuating demand

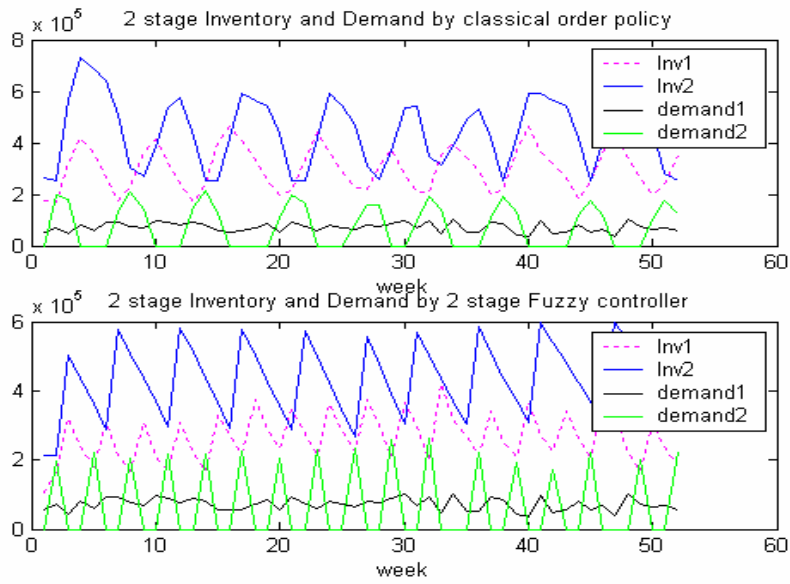

Figure 33. Response of two-stage model to fluctuating demand

(50% fluctuation; Inv1:1st stage inventory level; Inv2: 2nd stage inventory level; demand1: 1st stage demand from end customer; demand2: 2nd stage demand from downstream order)

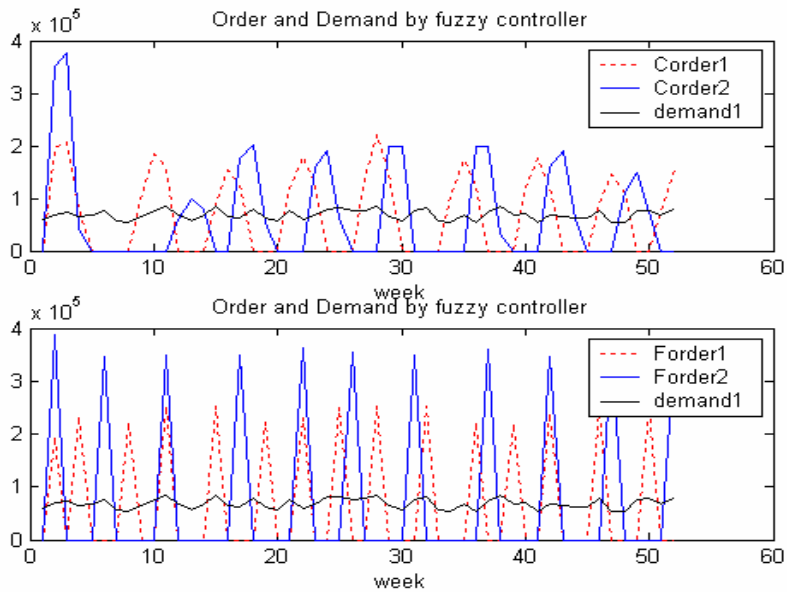

Figure 34. Response of order of 1st stage of two-stage model to fluctuating demand

(50% fluctuation; Corder1: 1st stage order by classical order policy; Cdemand1: 1st stage demand from end customer by classical order policy; Forder1:1st stage order by fuzzy controller)

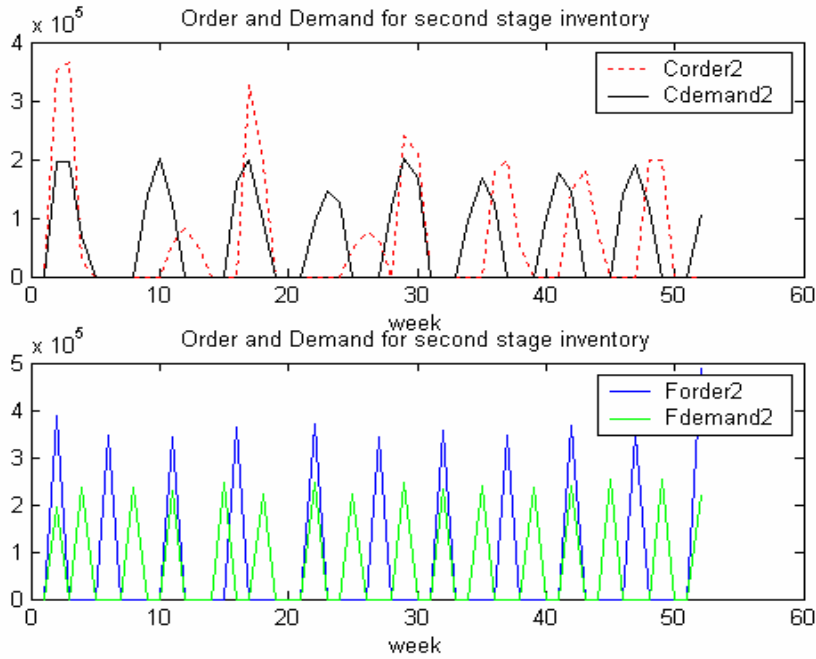

Figure 35. Response of order of 2nd stage of two-stage model to fluctuating demand (50% fluctuation; Corder2:2nd stage order by classical order policy; Cdemand2: 2nd stage demand from 1st stage order by classical order policy; Forder2:2nd stage order by classical fuzzy controller; Fdemand2: 2nd stage demand from 1st stage order by fuzzy controller)

Now the results are addressed from the above tables and figures, and the relevance reasoning behind the conclusions.

6.4 More Comparison

In terms of the results of average inventory level, annual cost and definition of the service level in the case study. Figure 36–38 give their comparison between the FICM and the (s, S) policy in the different demand distributions.

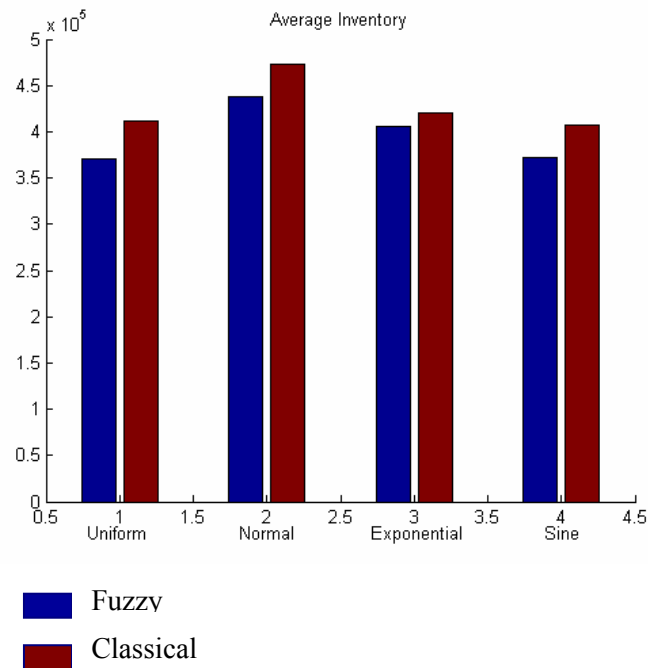

Figure 36. Comparison of average inventory level

Figure 36 shows the comparison for average inventory level of the extension (s, S) policy with the fuzzy model using the uniform, normal, sine wave and exponential demand distribution test that contains the stochastic demand case and demand with imprecise fluctuation case. The performance of the fuzzy model produces improved scores compared with the classical policy based on SIMM.

In terms of different demand distributions, the lowest average inventory level is found in uniform and sine distributions with fluctuation that is similar to uniform fluctuation with the demand of seasonal changing over one year. It means that the uniform demand case has better inventory level compared with other demand distributions under current testing assumptions.

Figure 37 shows how low the FICM has the annual cost in the uniform, normal, sine wave and exponential demand distribution tests compared with the extension (s, S) policy. The performance of the fuzzy model produces good scores compared with the extension (s, S) policy based on EOQ models, whose cost is higher than the fuzzy

model. Obviously, the case study could successfully apply a FICM with savings up to 15.49% – 58.45% in total annual costs in different demand cases. Moreover, the lowest annual cost is also found in the uniform or sine distribution, with fluctuations.

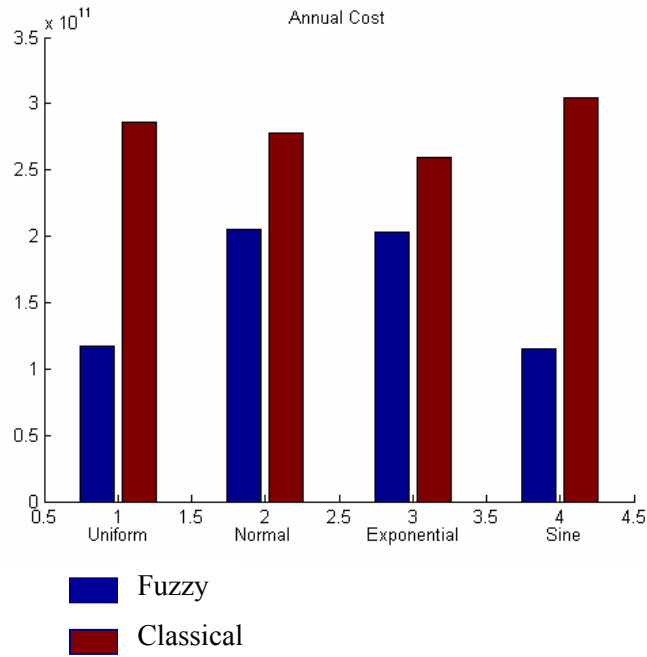

Figure 37. Comparison of annual cost

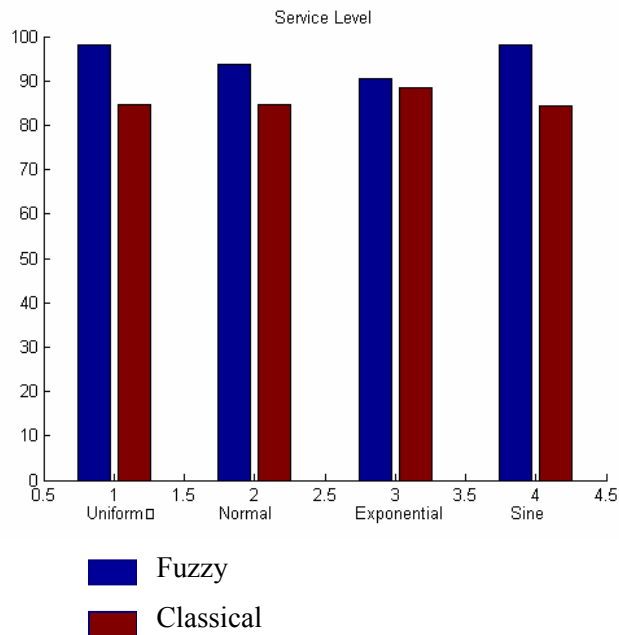

Figure 38. Comparison of service level

Figure 38 gives the comparison for average service level of (s, S) policy with the fuzzy model using the uniform, normal, exponential and sine demand distribution test. The performance of the fuzzy model produces improved scores compared with (s, S) policy, even though the cost of the latter is higher than the fuzzy model. Obviously, the case study can successfully apply a FICM with improvement in the customer service in different demand distributions. That means the FICM is able not only to lower inventory cost and level, but also produce a higher service level. It is shown that the highest service level is found in the uniform or sine demand distribution cases, with fluctuations.

In summary, whether with a comparison of annual cost, inventory level or service level, the simulation results have shown that the FICM provides a significant improved performance in the same situation compared with (s, S) policy based on EOQ models. Two possible reasons present themselves. First, the fuzzy model is created by modern fuzzy logic and the (s, S) policy based–traditional EOQ models. Fuzzy sets theory might be robust enough to handle fluctuating demand (marketing) and demand–magnification effect. It not only reduces the changing of inventory level and order times, but also improves the service level and ability to counteract demand fluctuations. Second, this cost–effective inventory model involves (s, S) policy based–EOQ models that easily react and decide when an order needs to be placed when it perceive changes in demand. Therefore, it might be that the costs and inventory levels outperform the (s, S) policy.

The simulation model and its results were based on ideal conditions in the iron and steel industry and the limited data provided by the case company. During experimental work, it shows different degrees of improvement with different parameters in distributions. The improvement is based on a reasonable selection of parameters of distribution according to the actual iron and steel industry. There could be different selections for different industries according to their demand. In order to make the system more realistic, unexpected events could be considered within the model, such as cases of supplier or vehicle breakdowns, flexible lead–time, human intervention (in handling material), and with more fluctuation in the materials market. These cases would

interrupt the schedule for the delivery of materials to the feeding of the production with flexible lead-time and flexible suppliers. In order to include these factors within the simulation study, more intensive research on transportation and marketing demands would have to be carried out. This type of work also requires a higher level of programming and more data from the applied industry. Other areas, such as an option for selecting more efficient transport types and their associated costs could also be incorporated.

Among all demand cases with different distributions, the uniform demand case in fuzzy model is obviously the best result in most situations as its less variation and better precision. It means the fuzzy-tuning might have more potential in the other demand cases, for instance a normal demand, etc., which might be the subject of another research topic.

7 SUMMARY AND SUGGESTIONS FOR FUTURE RESEARCH

7.1 Overview

This chapter presents a summary of the results, draws some conclusions from them, and presents suggestions for future research suggested by these conclusions.

7.2 Summary

In this thesis, a cost-effective FICM has been presented for an iron and steel company based on modern fuzzy logic control and a traditional inventory model subject to the stable demand case when the supply chain in a company is a push system, and the stochastic demand case and demand with imprecise fluctuation case when the company takes the changing markets into account and its steel production system becomes an incomplete push system or the steel supply chain shifts to multiple supply demand networks. Based on the simulation studies and the case study, it shows that the proposed FICM yields benefits from the features in the fuzzy logic controller and (s, S) policy. Hence, this research approach is fairly reliable and robust. This is a significant attribute of the research as it increases the usefulness of its application to real iron and steel industry problems. Moreover, the simplicity of the proposed model makes it easy to apply in other industries.

Based the research approach and the simulation results in case study, the research questions in Chapter 1 can be answered:

Question 1: Can the FICM be combined with the (s, S) policy to reduce the total inventory cost relative to SIMM?

The answer to this question is yes. As shown by the results based on the cases by the uniform, normal, sine wave and exponential demand distribution. For uniform distribution, the total annual cost of the FICM is much lower, even lower than 49.21% (*FP*). One reason for this is that the number of times of order (*OT*, see Table 11) is much less than when using (*s, S*) policy inventory system, the second reason is the inventory level (*AAI*) is lower, so that the total holding cost becomes lower, and the third reason is the order quantity is also lower because of the fuzzy issues. For normal and exponential distribution (See Table 12 and 14), the same reason applies, with the result that its total annual cost is still much lower, even lower than 35.32 % for normal and 28.94% for exponential demand distribution, and even though it is not higher like the uniform distribution, it is still positive. For the sine distribution (See table 13), the FICM is even better, its total annual cost is even lower than 55.24% (*FP*), and it is because the seasonal change over a year in the iron and steel industry by sine distribution is relatively slower. The same reason results in other performances of this seasonal distribution being close to the performance by uniform demand distribution.

Question 2: Can FICM reduce the ordering and shortage costs (and the total inventory cost) in case of (1) stochastic demand and (2) imprecisely fluctuating demand relative to SIMM?

In terms of the current data obtained from the case company, the answer to this question is positive. Figures 28–31 referring to the stochastic demand case and Figures 32–35 referring to the imprecisely fluctuating demand the FICM reduce the ordering and the total inventory cost, and emergency–order times (*ST*) in Table 11 – 15, the less emergency–order times cause the lower shortage costs. Moreover, Figures 28–35 show that the inventory level with the FICM are not only lower, but also much more stable than using the (*s, S*) policy inventory system with each demand distribution, since the FICM does not restrict itself to placing a fixed order quantity Q , but places a flexible order quantity based on forecast demand and inventory. The tables also show that the FICM reduces order times in both cases, the average ordering percentage *OP* is 30.77%/46.15%, 19.32%/25%, 21.15%/46.15% and 29.33%/48.56% (Fuzzy / (*s, S*))

with the related parameters in distributions as μ , σ and γ , etc., respectively. Note that Figures 32 (b), 34 and 35 show that some amplitudes of the order by the fuzzy model are higher than the classical model; the reason is its lower number of orders compared with the classical model for the same planning period (52 weeks); it also causes the oscillatory amplitude to be higher than the classical model – that means the single order quantity is higher than the classical model sometimes, but the mean of each order quantity is much lower than the classical model, which brings the mean order quantity of the FICM to be lower, thus the total annual cost and inventory level is much lower with the fuzzy model, as both *AAIP* (%) and *FP* (%) show positively.

Question 3: Can the FICM reduce the demand–magnification effect caused by the SIMM in a multi–stage supply–demand network?

With respect to counteraction to demand fluctuations, the FICM has a much more stable inventory level, and this makes for a less damping effect, proving that the fuzzy model also has stronger counteraction to demand fluctuations (See Figures 33 to 35 and Tables 19 to 21). That is of great significance when the inventory management is extended to multiple stage supply chain networks (two – stage model in the case study). The different percentage noise is added as demand fluctuations to demand input in the inventory model, from 30% to 70%, as shown in Tables 19–21 in the one – stage and two – stage inventory models with the random seeds plus fluctuations when the fluctuating iron and steel markets are considered. Table 19 shows the one – stage fuzzy controller in the inventory model has a higher counteracting ability to demand fluctuations (lower demand–magnification effect) and much better (lower) damping effect of inventory to the demand fluctuations than the classical model, and these results are also shown in Figure 32 (a), which demonstrates that the inventory level with the fuzzy model is lower compared to the classical model.

It is obvious that in the two – stage SDN, the FICM with the fuzzy controller not only has the ability of higher counteraction to demand fluctuations, but also the ability to lower inventory cost and inventory. In brief, the FICM that has been presented

demonstrates the lower damping effect of inventory to demand fluctuations and better ability to counteract the demand–magnification effect, mostly in areas that contain the annual cost, inventory level, order times, emergency–order times and service level, the benefits of which, with the fuzzy model, have been investigated in the previous tables.

For the two – stage FICM, Tables 18 and 19 give the performance measures of damping effect to inventory level and demand–magnification effect for each stage, and Figures 33, 34 and 35 demonstrate the response of the inventory levels and order quantities for each stage. Since the one – stage inventory model has shown superiority in damping effect of inventory with the fuzzy model as above, Table 20 only shows the damping effect of the two – stage fuzzy model so that the damping effect of each of the two stages can be compared. In Table 20, the first fuzzy controller in the inventory model has a much higher damping effect in different grade fluctuation to the demand fluctuations than the second fuzzy controller (Fuzzy2). This means that the demand fluctuations impacting on inventory level are becoming weaker through the two – stage fuzzy inventory controller in SDN. Figure 33 has the same good score, as the inventory of the second fuzzy inventory controller shows (Fuzzy2) less fluctuation than the first (Fuzzy1), which is next to the end customer. Table 21 shows the measures of the demand–magnification effect in each stage for the two – stage inventory model. It is obvious that the demand–magnification effect of each stage and the total demand–magnification effect of the upstream supplier to downstream–end customer are lower with the FICM. These results correspond with the discussion in the previous section that the demand–magnification effect will be much less when networks are crossed with two – stage fuzzy inventory controllers (Fuzzy1 and Fuzzy2). Therefore, in terms of the two – stage fuzzy model and the data from SLC in the case study, the FICM by fuzzy controller produces results that significantly out–perform the SIMM in the stochastic demand case and demand with imprecise fluctuation case caused by changing markets.

Question 4: Can the FICM show superior performance to the (s, S) policy in a supply – demand network?

The answer to this research question is again affirmative according to the case study and current data provided by the case company. In fact, most performances of the FICM outperformed the (s, S) policy with the demand distributions that were used, the data are summarised in Figures 28–35 and in Tables 11–21. As analysed above, in most areas that contain the annual cost, inventory level, order times, emergency–order times, counteraction to demand–magnification effect, etc., the fuzzy model based on fuzzy logic controller combined with (s, S) policy produced results that significantly outperformed the (s, S) policy based on EOQ models. With the performance–service level in all demand distributions (See Tables 11–14) under the current data provided by the SLC, the service level $r\%$ becomes higher using the FICM shown in the tables as the emergency–order (shortage) percentage becomes lower than (s, S) policy inventory system, the lower emergency–order also bring the lower shortage costs in FICM. The same results can also be shown in Figure 36, which also means the lower cost and inventory level of the FICM does not lower the service level. Besides, the simulation results in Figures 28–35 and in Tables 11–21, Figures 36–38 give the comparison between the FICM and the (s, S) policy in the different demand distributions, all these show FICM can be superior performance to the (s, S) policy in the case study and the current data provided by the case company.

As a result of this work, at least 4 novel contributions have emerged:

1. This research provides a cost–effective inventory model to the supply chain based on a synthesis of a traditional inventory model and a fuzzy logic controller, with the proposed FICM benefiting from traditional and modern issues for the real iron and steel industry. This is an extension application for fuzzy set theory and supply chain inventory management in practice. Although fuzzy set theory has been studied extensively over the past 40 years and applied in production management in some cases, this research first applied this theory to supply chain inventory control in the iron and steel industry. Modern fuzzy set theory is combined with classical inventory policy, and is applied to the traditional iron and steel industry, The aim was to make the raw materials inventory cost of the iron and steel industry more competitive, and compared

with its current inventory policy, which lacks efficiency and flexibility when the company's supply chain takes the changing markets into account, the proposed FICM is not much more complicated than the one currently in use in the company, and it will provide more benefits, as discussed earlier in Section 1.2.1.

2. Besides the uniform demand case that the case company has been using, the proposed FICM can be applied in cases of stochastic demand and demand with imprecise fluctuation caused by changing markets when the steel supply chain is concerned with fluctuating demand that the company has never taken into account in its old inventory policy.

As stated in Chapter 1, the iron and steel industry has become used to managing its production according to uniform distribution, which is only one kind of demand in this research, which provides some typical stochastic demand distributions and added fluctuations applied in the single inventory model and demand with imprecise fluctuation case (random seeds added fluctuations) when the changing market is considered. If this can be embedded into production management in the iron and steel industry, it has the potential for large cost savings in inventory control and raw materials feeding.

3. The FICM demonstrates the new attempt in the iron and steel industry. Its application to the supply chain in the iron and steel industry provides a new prospect in combining traditional with modern issues.

The proposed model not only can be used in a uniform demand case, but also in some other stochastic demand cases, and in the case of demand with imprecise fluctuation caused by changing markets when the iron and steel supply chain is concerned with the fluctuating steel market. In terms of the current data provided by the case company, this research provides a improved performance in counteracting the demand–magnification effect in the supply chain/supply demand networks for the iron and steel industry.

4. The synthesis of the modelling effort in the case study of a real company significantly increases its relevance and therefore perceived value to supply chains in real industries. The technology demonstration was successful for the final results. The proposed model will provide a basis for the supply chain inventory management of iron and steel-makers, and when iron and steel companies and other industries can have complete data and apply them in the fuzzy model; it will also be possible to extend to other industries. This will lead to higher efficiency in the supply chain in the iron and steel industry and be possible to extend to more industries when the complete data is offered.

7.3 Suggestions for Future Research

Based on this research, the model yields benefits for different levels of variability in supply chain inventory control, and fuzzy logic combined with the traditional model is a powerful tool for inventory control. However, since the data and relevance information was incomplete or limited, the model used was highly simplified. Most of the efforts of this research are based on current data and information from the case company. The system needs to be tested with more data and in more complex environments, and the following recommendations address areas to which additional research can be expected to be focused.

Firstly, alternate procedures may be used to create feasible solutions for the re-order point. In this case study, this was calculated by average lead-time demand ($D_{avg} \times L$) by incorporating safety stocks (SS) like the normal (s, S) policy. Future research may be to carefully study the optimal re-order point problem, which may be the function of inventory level and demand rates.

From some observations in running the simulation model, the equation does not change the value of the expected s given by (3–10) for almost all parameter values, but it ensures cost-effectiveness for all 4 demand distribution inputs. Based on the work by Ta-Wei Hung (1996, 1997) this value can be still modified and satisfy the demand and

inventory. This research does not pursue this issue further at this point but leaves it as an open issue to address in subsequent work based on these ideas.

Secondly, future research may consider more demand uncertainties in the model and take more account of the impact of demand fluctuations so as to make the model cope better with managing volatile demand across the entire the iron and steel supply chain. This could involve price fluctuations, changing energy markets, the delay of shipment from the supplier due to unforeseen events, disaster, and so on.

Thirdly, the complexity of the simulation may be increased by taking into account the various cost components. This could involve additional procedures to account for order creation costs, detailed costs of transport, warehouse maintenance costs, and a number of other complicating modifications.

Fourthly, the stochastic lead-time could be addressed using this model, if the possibility of order crossing is ignored. Based on the situation of the case company, I could simply approximate the lead-time constant, and ignore stochastic variation due to this particular iron and steel industry. If there could be variation of lead-time, but this is simply ignored, then the proposed model would be even more approximate. The efficiency of using the method of ignoring lead-time variation (when it exists sometimes) could be determined. According to Quick Response Manufacturing (QRM) developed by Suri, which was discussed in Chapter 3, lead-time might consider more time formulae.

Fifthly, since the uniform demand case or similar to uniform_distribution in the case study-sine demand case in the fuzzy model shows best results in most situations, and this research is specific to the iron and steel industry, further research might be carried out on the fuzzy-tuning corresponding to each demand distribution in the stochastic demand case and demand with imprecise fluctuation case, when the changing situation is considered in the iron and steel markets. Moreover, it is also possible to expand the research to other industry with the stochastic demand case and demand with imprecise

fluctuation case, which is suitable to corresponding demand distribution and fuzzy-tuning.

Finally, the relative application of the multiple stage inventory case could be expanded in the more complicated downstream sites with stochastic steel and iron markets. The steps should take the rest of the steel-making process and more downstream partners into account; this process is from iron-making (BF) to steel-making in a basic oxygen furnace (BOF), then casting mill, rolling mill steps in the steel industry and the architecture industry, car-makers, even the military industry, and so on. Chapter 1 has stated that these industries fluctuate sharply according to the situation of the developing economy, war and even regional conflicts. Additionally, the ability of the control system to deal with multiple stage supply should be addressed. An option may be to solve such problems level by level for different production stages and industries, but this idea demands a considerable amount of further work.

REFERENCES

- Adam, Ritt. (2001). The bottom line: Inventory. *Iron Age New Steel* 17:3 (March), 16–20. New York.
- Anderson, D.L. & H.L. Lee (2001). New supply chain business models – The opportunities and challenges. *The ASCET Project 3* (May). Stanford University.
- Ballard, B. & Andrew Zozom Jr. (1996). A comparison of inventory systems: (Q, r) vs. fuzzy control. *OR591: Fuzzy Optimization and Decision Making* 7 (May).
- Beamon, B.M. (1999). Measuring supply chain performance. *International Journal of Operations and Production Management* 19:3, 275–292.
- Beamon, B.M. & V.C.P. Chen (2001). Performance analysis of conjoined supply chains. *International Journal of Production Research* 39: 14, 3195–3218.
- Beltran, J.L. & D. Krass (2002). Dynamic lot sizing with returning items and disposals. *IIE Transactions* 34, 437–448.
- Boute, Robert N. et al. (2005). *Bullwhip Reduction and Win-win Strategies*. (<http://euterpe.cmi.ua.ac.be/pats/publications/2005/EUROMA.pdf>)
- Buckley, J. J., T. Feuring & Y. Hayashi (2002). Solving fuzzy problems in operations research: inventory control. *International Journal of Soft Computing* 7:2, 121–129.
- Burbidge, John L. (1978). *The Principles of Production Control*. Plymouth: Macdonald and Evans,
- Burbidge, John L. (1984). Automated production control with a simulation capability, *Proceedings of IFIP Conference WG5–7*, Copenhagen.
- Burbidge, John L. (1985). Production Planning and Control: A Personal Philosophy. *Computers in Industry* 6:6, 477–577.
- Burbidge, John L. (1989). *Production Flow Analysis for Planning Group Technology*. Oxford: Clarendon Press.
- Cachon, G. & M. Lariviere (2001). Contracting to assure supply: how to share demand forecasts in a supply chain. *Management Science* 47:5, 629–646.
- Carlsson, C. & R. Fullér (2000). A fuzzy approach to the bullwhip effect. *Cybernetics and Systems 2000*, Austrian Society for Cybernetic Studies, Vienna 2000, 228–233.

- Carlsson, C. & R. Fullér (2000). Soft computing and the bullwhip effect. *Economic and Complexity* 2:3 (Winter), 1–26.
- Carlsson, C. & R. Fullér (2001). Reducing the bullwhip effect by means of intelligent, soft computing methods. *Proceedings of the 34th Hawaii International Conference on System Sciences*.
- Chen, Frank, Y. & Y. Feng (2001). Optimization of (s; S) inventory models with non-quasiconvex costs and applications. *The Chinese University of Hong Kong Shatin*. <http://www.se.cuhk.edu.hk/~yhchen/ssalgo3.pdf>.
- Chen, L. & G.–R. Chen (2000). Fuzzy Modelling, prediction, and control of uncertain chaotic systems based on time series. *IEEE Transactions on Circuits and Systems—I: Fundamental theory and applications* 47:10 (October), 1527–1531.
- Chen, Y.–W. & G.–H Tzeng (2000). Fuzzy multi-objective approach to the supply chain model. *International Journal of Fuzzy Systems* 2:3 (September).
- Chubbs, S. (2002). Iron and steel report. *International Iron and Steel Institute*. http://www.unep.fr/outreach/wssd/contributions/sector_reports/sectors/iron-steel/iron-steel_sum.htm.
- Cohen, M.A., S. Nahmias & W.P. Pierskalla (1980). A dynamic inventory system with recycling. *Naval Research Logistics* 27:2, 289–296.
- Derrick, R.D. (2003). Challenging the bullwhip effect with advanced information sharing. *Accenture*, Outlook point of view (March).
- Disney, S.M. & D.R. Towill (2003). Vendor-managed inventory and bullwhip reduction in a two-level supply chain. *International Journal of Operations & Production Management* 23:6, 625–651.
- Donovan, R.M. (2002). Supply chain management: cracking the “bullwhip effect”, Part III. Performance improvement. *Information Technology Toolbox* (Feb).
- Esogbue, A.O. & B.–D. Liu (1997). Fuzzy criterion dynamic programming and optimal control of multi-dimensional open inventory networks. *Proceedings of the Sixth IEEE International Conference on (Fuzzy Systems '1997)*, Volume: 2, 1–5 July. vol.2, 755–760.
- Fisher, M. L., J. Hammond, W.R. Obermeyer & A. Raman (1997). Configuring a supply chain to reduce the cost of demand uncertainty”. *Production and Operations Management* 6:3, 211–25.
- Fisher, M.L. (1974). Optimal solution of scheduling problems using Lagrangian multipliers, Part. *Operations Research* 21, 1114–1127.

- Fisher, M.L., B.J. Lageweg, J.K. Lenstra & A.H.G Kan Rinnooy (1983). Surrogate duality relaxation for job shop scheduling. *Discrete Applied Mathematics* 5, 65–75.
- Fleischmann, M. & R. Kuik (1998). On optimal inventory control with stochastic item returns. *Management Report Series 2*. Netherlands: Erasmus University Rotterdam.
- Forrester, Jay W. (1958). Industrial dynamics – a major breakthrough for decision makers. *Harvard Business Review* 36:4, 37–66.
- Forrester, Jay W. (1961). *Industrial Dynamics*. Cambridge: Massachusetts Institute of Technology.
- Forrester, Jay W. (1968). Market growth as influenced by capital investment. *Industrial Management Review* 9:2, 83–105.
- Fransoo, Jan C. & J.F. Marc Wouters (2000). Measuring the bullwhip effect in the supply chain. *International Journal of Supply Chain Management* 5:2, 78–89.
- Frohlich, M. & R. Westbrook (2001). Arcs of integration: an International study of supply chain strategies. *Journal of Operations Management* 19, 185–200.
- Grange, F. (1998). Challenges in modelling demand for inventory optimization of slow-moving items. *Proceedings of the 30th conference on winter simulation. December*, 1211–1217.
- Guiffrida, A.L. & R. Nagi (1997). *Fuzzy set theory applications in production management research: a literature survey*. <http://www.acsu.buffalo.edu/~nagi/pubs/fuzzy.pdf>.
- Hill, Roger M. & S.G. Johansen (2006). Optimal and near-optimal policies for lost sales inventory models with at most one replenishment order outstanding. *European Journal of Operational Research* 169, 111–132.
- Houlihan J.B. (1987). International supply chain management. *International Journal of Physical Distribution and Materials Management* 17:2, 51–66.
- <http://www.business.auburn.edu/~gibsobj/2006%20%20AMLG%205770/AMLG%205770%20-%20Chapter%2003.ppt>.
- <http://www.cen.uiuc.edu/courses/ie261/ie262/notes/invm/h1/IE373-Inventory-1.html>.
- http://www.issb.co.uk/pdf/200402_china.pdf.
- <http://www.managingautomation.com/maonline/channel/DemandDrivenSupplyNetwork>

s/.

<http://www.seattlerobotics.org/encoder/mar98/fuz/flindex.html>.

<http://www.uh.edu/~djwells/guidelines/guidelines.html>.

Hung, Ta-Wei., S.-C. Fang, H.L.W. Nuttle & R.E. King (1997). A fuzzy-control-based quick response re-order scheme for retailing of seasonal apparel. *Proceedings of the International Conference of Information Sciences* 2, 300–303.

Jang, J.-S.R., C.-T. Sun & E. Mizutani (1997). *Neuro-Fuzzy Soft Computing*. Prentice Hall, Inc.

Johansen, S.G. (2001). Pure and modified base stock policies for the lost sales inventory system with negligible set-up costs and constant lead times. *International Journal of Production Economics* 71, 391–399.

Johansen, S.G., and Thorstenson, A. (1998). An inventory model with Poisson demands and emergency orders. *International Journal of Production Economics* 56, 275–289.

Johansen, S.G. & R.M. Hill (2000). The (r, Q) control of a periodic review inventory system with continuous demand and lost sales. *International Journal of Production Economics* 68, 279–286.

Karmarkar, U.S. (1987). Lot sizes, lead-time and in process inventories. *Management Science*, 33:3, 409–418.

Karmarkar, U.S. (1989). Capacity loading and release planning with Work-in-Progress (WIP) and lead-time. *Journal of Manufacturing and Operations Management*, 2:2, 105–123.

Karmarkar, U.S. (1993). Manufacturing lead-times, order release and capacity loading. In: *Handbooks in Operations Research and Management Science, Logistics of Production and Inventory* 4:6. Eds A.R. Kan Graves & P. Zipkin, Amsterdam: North-Holland.

Karwowski, W. & G. W. Evans, (1986) Fuzzy concepts in production management research: a review. *International Journal of Production Research* 24:1, 129–147.

Kazan, O., R. Nagi & Christopher M. Rump (2000). New lot-sizing formulations for less nervous production schedules. *Computers & Operations Research* 27, 1325–1345.

Kelle, P. & E.A. Silver (1989). Purchasing policy of new containers considering the random returns of previously issued containers. *IIE Transactions* 21, 349–354.

- Klir, G.J., B. Yuan & U.H. Saint Clair (1997). *Fuzzy Set Theory: Foundations and Applications*. Prentice Hall.
- Kok, A.G de (1990). Basics of inventory management: Part 2 the (r, s) model. *Technical report, Department of Economics*. Tilburg University.
- Lee, C.-C. (1990). Fuzzy logic in control systems, *IEEE International Conference on Systems, Man, and Cybernetics (SMC)* 20:2, 404–35.
- Lee, H. L., C. S. Kut & C.-S. Tang (2000). The Value of information sharing in two-level Supply Chain, *Management Science* 46:5, 626–643.
- Lee, H.L. & S. Nahmias (1993). Single-product, single-location models. In *Handbooks in Operations Research and Management Science* 4, Logistics of Production and Inventory. Eds S. C. Graves, A. H.G. Rinnooy Kan & P. H. Zipkin. NY: North-Holland.
- Lee, H.L. & C.-S. Tang (1997c). Modelling the costs and benefits of delayed product differentiation. *Management Science* 43:1, 40–53.
- Lee, H.L., V. Padmanabhan & S. Whang (1997b). Information distortion in a supply chain, the bullwhip effect. *Management Science* 43:4, 546–558.
- Lee, H.L., V. Padmanabhan & S. Whang (1997a). The bullwhip effect in Supply Chains. *Sloan Management Review* 38: 3 (Spring), 93–102. Cambridge.
- Lee, Y.-Y., B. A. Kramer & C. L. Hwang (1990). Part-period balancing with uncertainty: a fuzzy sets theory approach. *International Journal of Production Research* 28:10, 1771–1778.
- Lee, Y.-Y., B. A. Kramer & C. L. Hwang (1991). A comparative study of three lot-sizing methods for the case of fuzzy demand. *International Journal of Operations and Production Management* 11:7, 72–80.
- Li Y. & G.-W.Tan (2004). Information sharing in a supply chain with dynamic consumer demand pattern. *Proceedings of the 37th Hawaii International Conference on System Sciences*.
- Li, J., M.J. Shaw & G.-W. Tan (2000). Evaluating information sharing strategies in supply chains. *Proceedings of 8th ECIS*, Vol. 1, Vienna, Austria, 3–5 July. 437–444.
- Li, L-S., S. N. Kabadi & K. P. K. Nair (2002). Fuzzy models for single-period inventory problem. *Fuzzy Sets and Systems* 132:3, 273–289.
- Li, Sh.-Y. (1998). *Fuzzy Control, Neurocontrol and Intelligent Cybernetics*, 2nd Edition.

- Mahadevan, B. et al. (2003). Periodic review, push inventory policies for remanufacturing. *European Journal of Operational Research* 151, 536–551.
- Mamdani, E. H. & S. Assilian (1975). An experiment in linguistic synthesis with a fuzzy logic controller. *Int. J. Man–Mach. Stud.* 7, 1–13.
- Mamdani, E.H. (1997). Application of fuzzy logic to approximate reasoning using linguistic synthesis. *IEEE Transactions on Computers* 26:12, 1182–1191.
- MatLAB 6.5, *Fuzzy Logic Toolbox, Help*.
- McCullen, P. & R. Saw (2001). Designing the agile supply chain. *Proceeding of International Symposium on Logistics*, Salzburg Austria, 129 – 136.
- Mohebbi, E., & M.J.M. Posner (1999). A lost–sales continuous–review inventory system with emergency ordering. *International Journal of Production Economics* 58, 93–112.
- Moinzadeh, K. & S. Nahmias (1988). A continuous review model for an inventory system with two supply modes. *Management Science* 34:6, 761–773.
- Mondal, S. & M. Maiti (2003). Multi–item fuzzy EOQ models using genetic algorithm. *Computers and Industrial Engineering* 44:1, 105–117.
- Muckstadt, J.A. & M.H. Isaac (1981). An analysis of single item inventory systems with returns. *Naval Research Logistics* 28:2, 237–254.
- Murgiano, C. J. (1994). Short lead–times = Tall profits. *Waterloo Manufacturing Software*. USA.
- Murgiano, C. J. Competitive advantage through cost effective – on time delivery. *Waterloo Manufacturing Software*, USA. <http://www.waterloo–software.com/pdf/consult1.pdf>.
- mySAP™ SCM AT HYLSA (2002). SAP case study, mySAP supply chain management. *SAP AG*.
- Nahmias, S. (1989). *Production and Operations Analysis*. Homewood, IL: Richard D. Irwin, Inc.
- Namit, K. & J. Chen (1999). Solutions of the $\langle Q, r \rangle$ inventory model for gamma lead–time demand. *International Journal of Physical Distribution & Logistics Management* 29:2, 138–51.
- Narasimha, B. Kamath & R. Rahul (2005). Supply chain structure design for a short lifecycle product: a loop dominance based analysis. *Proceedings of the 38th Hawaii International Conference on System Sciences – 2005*.

- Oracle Corporation. (2002). *Data sheet. ORACLE DEMAND, PLANNING 11i*.
- Oracle Corporation. (2004). *Jinan Steel Forges Market Leadership with Integrated ERP Solution*
- Park, K. S. (1987). Fuzzy–set theoretic interpretation of economic order quantity. *IEEE Transactions on Systems, Man and Cybernetics* 17:6, 1082–1084.
- Petrovic R. & D. Petrovic (2001). Multicriteria ranking of inventory replenishment policies in the presence of uncertainty in customer demand. *International Journal of Production Economics* 71:1–3, 439–446.
- Porter, M. (1998) *Competitive Strategy: Techniques for Analyzing Industries and Competitors*. Free Press.
- Pyke, D.F. (1987). Push and pull in integrated production–distribution systems under stochastic demand. Unpublished PH.D. Dissertation. Wharton School of Management, University of Pennsylvania.
- Ramasesh, R.V., J.K. Ord, J.C. Hayya & A. Pan (1991). Sole versus dual sourcing in stochastic lead–time (s,Q) inventory models. *Management Science* 37:4, 428–443.
- Richter, K. (1996). The EOQ repair and waste disposal model with variable setup numbers. *European Journal of Operational Research* 95:2, 313–324.
- Rosling, K. (1997). The (r, Q) inventory model with lost sales, Research report. Department of Industrial Engineering. Sweden: Lund University.
- Rosling, K. (2002). Inventory cost rate functions with nonlinear shortage costs. *International Journal of Operations Research* 50:6 (November–December), 1007–1017.
- Rosling, K. (2002). The (r, Q) inventory model with lost sales. *SE–391 95 Växjö* (December). Sweden.
- Schrady, D. (1967). A deterministic inventory model for repairable items. *Naval Research Logistics* 14, 391–398.
- Silver, EA. and Meal, HC. (1973). A heuristic for selecting lot size quantities for the case of a deterministic time–varying demand rate and discrete opportunities for replenishment. *Production and Inventory Management* 14, 64–74.
- Simpson, D. (2005). Metals, the metals advantage. *APPLIANCE Magazine*. August.
- Simpson, V.P. (1978). Optimum solution structure for a repairable inventory problem. *Operations Research* 26:2, 270–281.

- Sinha, G. P., N. Mitter, S.B. Singh, G. Dutta, P.N. Roy, B.S. Chandrasekaran & A.R. Choudh (1995). Strategic and operational management with optimization at Tata steel. *Interfaces* 25, 6–19.
- Sommer, G. (1981). Fuzzy inventory scheduling, in *Applied Systems and Cybernetics VI*, 3052–3060. Ed. G.E. Lasker. New York: Pergamon Press.
- Sugeno, M. (1985). Industrial applications of fuzzy control. *Elsevier Science Pub. Co.*
- Suri, R. (1981). New techniques for modelling and control of flexible automated manufacturing systems. *Proceeding IFAC*. Japan: Kyoto.
- Suri, R. (1998). *Quick Response Manufacturing: A Companywide Approach to Reducing Lead-times*. Productivity Press.
- Taha, H.A. *Operations Research, an Introduction, Macmillan Publishing Company*, 5th Edition. New York.
- Taha, H.A. *Operations Research, an introduction, Macmillan Publishing Company*, 6th Edition. New York.
- Tan, G.W. (1999). The impact of demand information sharing on supply chain network, *PHD Thesis* in Business Administration in the Graduate College of the University of Illinois at Urbana–Champaign.
- Tan, G.–W. & B. Wang (2001). The relationship between product nature, demand patterns and information sharing strategies. *Proceedings of 22nd ICIS* 16–19 (December), 543–549. USA: New Orleans.
- Teunter, R.H. (2001). Economic ordering quantities for remanufacturable item inventory systems. *Naval Research Logistics* 48:6, 484–495.
- Towill D.R. (1991). Supply chain dynamics. *International Journal of Computer Integrated Manufacturing* 4:4, 197–208.
- Towill, D.R. & A. Del Vecchio. (1994). The application of filter theory to the study of supply chain dynamics. *Production Planning and Control* 5:1, 82–96.
- Towill, D.R. & P. McCullen (1999). The impact of agile manufacturing on supply chain dynamics. *International Journal of Logistics Management* 10:1, 83–95.
- Tyworth, J.E. & R. Ganeshan (2000). A note on solutions to the (Q, r) inventory model for gamma lead–time demand. *International Journal of Physical Distribution & Logistics Management* 30:6, 534–539.

- Van der Laan, E., R. Dekker & M. Salomon (1996). Product remanufacturing and disposal: A numerical comparison of alternative control strategies. *International Journal of Production Economics* 45, 489–498.
- Van der Laan, E., R. Dekker, M. Salomon & A. Ridder (1996). An (s, Q) inventory model with remanufacturing and disposal. *International Journal of Production Economics* 46–47, 339–350.
- Van der Laan, E., M. Salomon, R. Dekker & L. Van Wassenhove (1999). Inventory control in hybrid systems with remanufacturing. *Management Science* 45:5, 733–747.
- Vujosevic M., D. Petrovic & R. Petrovic (1996). EOQ formula when inventory cost is fuzzy. *International Journal of Production Economics* 45, 499–504.
- Wagner, HM & TM Whitin (1958). Dynamic version of the economic lot size model. *Management Science* 5: 89–96.
- Wang, B. (2002). Relationship between Product Nature, Demand Patterns and Information Sharing Strategies. Master Thesis. National University of Singapore.
- Whisler, W.D. (1967). A stochastic inventory model for rental equipment. *Management Science* 13:9, 640–647.
- Wilson, S.K. (2003). Extend optimization, extending visibility, too. *Metal Producing & Processing* (January 01), 34–36.
- Xiong, G.–Y. & P. Helo (forthcoming). An application of cost-effective fuzzy inventory controller to counteract demand fluctuation caused by bullwhip effect. *International Journal of Production Research*.
- Zadeh, L.A. (1973). The concept of a linguistic variable and its application to approximate reasoning. *Memorandum ERL–M 411* (October). Berkeley.
- Zadeh, L.A. (1975). The concept of a linguistic variable and its application to approximate reasoning. *Information Sciences*, Part 1: 8, 199–249; Part 2:2, 301–357; Part 3: 9,43–80.
- Zhu, J.–X. & B. van Asten (1996). Fuzzy inventory control. *OR 591 project* 10 (May).

APPENDIX 1. LOT SIZE SYSTEM–ECONOMIC ORDER QUANTITY

When $p = \infty$ (Figure 4), the total cost is given by (3–3), it formulates the model as:

$$C(Q) = C_h(Q) + C_o(Q)$$

(Taha, Operations Research, an Introduction, Macmillan Publishing Company, 5th Edition.)

From Figure 4, it is clear that the times when stock exceeds $Q/2$ are exactly balanced by the times when stock falls below $Q/2$. In other words we could equivalently regard the Figure 4 as representing a constant stock level of $Q/2$ over time. Therefore, when average inventory level = $Q/2$, demand rate is a constant, then

$$C_h(Q) = hI_1 = h \frac{Q}{2}$$

Where r/Q is the order quantity per year (r used, Q each order quantity), then

$$C_o(Q) = KI_2 = K \frac{1}{t} = K \frac{r}{Q}$$

$$C(Q) = C_h(Q) + C_o(Q) = h \frac{Q}{2} + K \frac{r}{Q}$$

$$\frac{dC(Q)}{dQ} = \frac{d}{dQ} h \frac{Q}{2} + \frac{d}{dQ} K \frac{r}{Q}$$

$$= \frac{h}{2} - K \frac{r}{Q^2}$$

The optimum value of Q is obtained by minimizing $C(Q)$ with respect to Q . Thus, assuming that Q is continuous variable, it has

$$\frac{dC(Q)}{dQ} = 0 \quad \frac{h}{2} - K \frac{r}{Q^2} = 0$$

This yields the optimum order quantity as:

$$Q_o = \pm \sqrt{\frac{2Kr}{h}}$$

Where:

K =set-up (or ordering) cost for placing an order

Money/order

h = holding cost per unit inventory per unit time

Money /unit/period

r = demand rate

Note: the purchasing cost and shortage cost is not taken into account in this analysis.

APPENDIX 2. CALCULATING THE OPTIMAL VALUE S_o

(<http://www.cen.uiuc.edu/courses/ie261/ie262/notes/invm/h1/IE373-Inventory-1.html>)

Leibnitz Rule

If $F(t) = \int_{a(t)}^{b(t)} \phi(D, t) dx$, where a and b are differentiable functions of t and $\phi(D, t)$ and

$\frac{\partial}{\partial t} \phi(D, t)$ are continuous in D and t , then

$$\frac{d}{dt} F = \int_{a(t)}^{b(t)} \frac{\partial \phi(D, t)}{\partial t} dD + \phi[b(t), t] \frac{db(t)}{dt} - \phi[a(t), t] \frac{da(t)}{dt}$$

$$C(S) = h \left[\int_0^S \left(S - \frac{x}{2} \right) f(x) dx + \int_S^{\infty} \frac{S^2}{2x} f(x) dx \right] + g \left[\int_S^{\infty} \frac{(x-S)^2}{2x} f(x) dx \right]$$

$$\frac{d}{dS} C(S) = h \left[\int_0^S f(x) dx + \int_S^{\infty} \frac{S}{x} f(x) dx \right] + g \int_S^{\infty} \frac{-(x-S)}{x} f(x) dx$$

$$= h \int_0^S f(x) dx + h \int_S^{\infty} \frac{S}{x} f(x) dx - g \int_S^{\infty} \left(1 - \frac{S}{x} \right) f(x) dx$$

$$-g \int_S^{\infty} \left(1 - \frac{S}{x} \right) f(x) dx = -g \int_S^{\infty} f(x) dx + g \int_S^{\infty} \frac{S}{x} f(x) dx = -g \left[1 - \int_0^S f(x) dx \right] + g \int_S^{\infty} \frac{S}{x} f(x) dx$$

$$= -g + g \int_0^S f(x) dx + g \int_S^{\infty} \frac{S}{x} f(x) dx$$

$$\frac{dC(S)}{dS} = h \int_0^S f(x) dx + h \int_S^{\infty} \frac{S}{x} f(x) dx - g \int_S^{\infty} \left(1 - \frac{S}{x} \right) f(x) dx$$

$$\frac{dC(S)}{dS} = h \int_0^S f(x) dx + h \int_S^{\infty} \frac{S}{x} f(x) dx - g + g \int_0^S f(x) dx + g \int_S^{\infty} \frac{S}{x} f(x) dx = 0$$

$$(h + g) \int_0^S f(x) dx + (h + g) \int_S^{\infty} \frac{S}{x} f(x) dx = g$$

$$\int_0^{S_0} f(x) dx + \int_{S_0}^{\infty} \frac{S_0}{x} f(x) dx = \frac{g}{(h + g)}$$

S_0 can be calculated from the above equation

Where:

h = holding cost per unit inventory per unit time

Money /unit/period

g = shortage or emergency-order cost

Money / unit

APPENDIX 3. CALCULATING THE OPTIMAL VALUE OF S_0 WHEN $D > S$ IN CONTINUOUS MODEL WITH INSTANTANEOUS DEMAND

The optimal value of S is obtained by equating the first derivative of $C(S)$

$$\frac{d}{dS} C(S) = h \int_{D=0}^S f(D) dD - g \int_{D=S}^{\infty} f(D) dD$$

$$\frac{d}{dS} C(S) = h \int_{D=0}^S f(D) dD - g \left(1 - \int_{D=0}^S f(D) dD \right)$$

$$\frac{d}{dS} C(S) = 0$$

$$0 = h \int_{D=0}^S f(D) dD - g + g \int_{D=0}^S f(D) dD$$

$$\int_{D=0}^{S_0} f(D) dD = \frac{g}{h + g}$$

The value S_0 corresponds to the minimum point.

(Taha, H.A. Operations Research, an Introduction, Macmillan Publishing Company, 5th Edition. Note: the purchasing cost is not taken into account)

Where:

h = holding cost per unit inventory per unit time

Money /unit/period

g = shortage or emergency-order cost

Money / unit

APPENDIX 4. QAM PERFORMANCE AND CONCEPTS

According to Suri, some concepts and performance measure are used for lead-time. One of important performance is given by:

$$U=TJ/TA$$

In production, since each job needs to queue and then be processed, the average lead-time is the sum of the average queue time and average processing time:

$$LT=QT+TJ$$

Where:

TJ= Mean time to process a job (set-up or order time + process time)

TA= Mean time between arrivals of jobs to work centre (production)

QT= Average queue time for a job (time from arrival of job to when it begins being processed at the work centre)

U= Utilization of work centre

LT= Average lead-time for a job (time from arrival of job to its completion)

For the purpose of estimating lead-time by variability, LT can be changed as:

$$LT=TJ/ (1-U)$$

APPENDIX 5. RECENT DEVELOPING OF IT TECHNOLOGY IN THE STEEL SUPPLY CHAIN

Iron and steel industry is traditionally a very boom–and–bust cyclical industry. In early 21 century, the world steel market is in a deep slump. The international prices of steel have crashed below the production costs of even the above–average mills in terms of efficiency and much of the steel industry was suffering. Simpson (2005) reviews steel prospects in 2000, in North America, and the American Iron and Steel Institute (AISI) reports that the steel industry saw 41 bankruptcies and lost 55,000 employees. However, later on, steel demand has continued upward according to rapid economic growth. With strong growth of steel demand, steel companies such as United States Steel (Pittsburgh, PA, U.S.) and Nucor Corporation (Mt. Pleasant, SC, U.S.) have been reporting strong financial results.

Along with the surging demand of steel product, boom demand is putting pressure on the availability and prices of raw materials supply chain in world steel industry due to steel industry is sensitive to the impact of raw materials on its total manufacturing costs. In the steel industry, raw materials, including ore and coke, make up the majority of the manufacturing cost of steel and its related product. It is obvious that without adequate supplies of materials the global steel industry will absolutely be unable to meet the expected growth in world steel consumption. Many steel companies has been considering to raw material supply to meet sharp fluctuation of steel demand.

Facing with high pressure on supply chain in steel industry, advanced supply chain software or IT (Information Technology) solutions based on e–Commerce might be an alternative to steel industry, which has empowered steel companies to achieve a better synchronization and extending visibility of the value chain through a whole range of production management improvements. One of the main motivations for application of IT solution in the steel industry is the objective to combine maximizing profits to steel company and real–time steel demand. IT solution based on e–Commerce will make extending visibility across entire supply chain in the steel industry.

Earlier good case of supply chain software, e.g. Tata steel has been striving to optimize its operation amidst scarce resources and capacity imbalance since 1985. Aimed at capacities and resources varying from period to period, Tata discontinued using manual planning method in 1985 in favor of model-based planning for guiding marketing strategies in Tata's product mix area, which works planning model to provide information on the optimal product mix. This model brought a shifting from maximizing tonnage to maximizing contribution to profit in supply chain management strategy in Tata.

Along with a number of new supply chain software nowadays, more and more steel companies have been utilizing or starting consideration new supply chain software in their steel supply chain management. IT solution based on e-Commerce brings fact that it is becoming a technical reality to extend visibility across supply chain for steel industry.

Wilson (2003) summarizes the advantages of extended supply chain visibility improves optimization as follows:

1. Streamlined automated transaction processing and order tracking, for buying and fulfillment
2. Simplified planning and management with supply chain partners, from raw materials receipt through to customer delivery
3. Collaborative, proactive monitoring and measuring of key performance objectives.
4. Real-time electronic communication with supply chain (and other business) partners
5. Year-round marketing via online promotion and sales
6. Lower personnel costs thanks to automated business transactions
7. Real-time monitoring of customer buying habits

Except existing supply chain software, steel-makers can also select any adequate supply chain IT solution product. Whatever software, the aim of steel-maker is to gain

extended supply chain visibility improves optimization for their production as Wilson's previous summary (2003). The steel company can also design its own supply chain software respond to requirement of supply chain. One of good case is Oracle ERP (Enterprise Resource Planning) enables China's Jinan Steel to merge its production, information and cash flows into a single system. Realizing that an important key to competitiveness is a solid IT platform, Jinan Steel decided to create a commercially proven e-business system that would integrate strategy and execution, and boost profits by optimizing internal and external resources. Jinan began the upgrade in 2003, calling on Han Consulting to help design and implement a new enterprise resource planning (ERP) system based on Oracle E-Business Suite solutions. Already the new system has been yielding measurable operational improvements, from better production planning and lower costs to faster strategic decision-making.

Among number of new IT solutions in steel supply chain, TOC (Theory of Constraints) concept is a total different solution from other IT solutions and traditional supply chain management. There are five steps to TOC presented by Goldratt: identify the constraint, exploit it, subordinate everything else to it, elevate the constraint, and avoid inertia when the constraint shifts. In exploiting the constraint, the drum-buffer-rope scheduling technique and buffer management are used. In finding ways to elevate the constraint, the techniques of effect-cause-effect and the cloud diagram often are useful. The good example of TOC is LeTourneau, Inc. (USA). LeTourneau's vertically integrated supply chain begins with its Steel Group, which was chosen to implement the TOC concepts first due to the fact that they represent the beginning of the supply chain and alternative steel sources simply do not exist in one of the hottest steel markets in the last 30 years. In just three months, the Steel Group reported an increase of 14% more volume with no additional staffing and 5% less overtime. Average lead times were reduced 50%. Reliability improvements went from 67% on time to 87% and are steadily improving. As of this press release they had just completed four straight weeks at 90%. "The most significant improvement for the Steel Group that TOC has given us is total visibility of the facility from one end to the other end. And its visibility is not just limited to a few select individuals, but every employee in the Steel Group. We now manage from a

proactive style rather than a reactive style due to the increased visibility.” (Dave Blazek, Vice President and General Manager of the Steel Group, 2004). No doubt that TOC provides a new supply chain solution for steel industry.

APPENDIX 6. SOURCE CODE FOR “INVENTORY MODEL”**Appendix 6.1. Main program (PROGRAM_thesis.m)**

```

%%%%%%%%%%%%%%%%%%%%%%%%%%%%%%%%%%%%%%%%%%%%%%%%%%%%%%%%%%%%%%%%%%%%%%%%
%This is a Matlab code for the fuzzy inventory model
%and (s,S) policy.
%Guangyu Xiong all rights reserved 2005

clear all
close all
%Input demand
distribution_data_gyu;
DemandDistributions=1;
%2'UNIFORM';1'NORMAL';3'POISSON';4'EXPONENTIAL';5'SINE';

switch DemandDistributions
    case 1
        Demand=G1_normal;
    case 2
        Demand=G1_uniform;
    case 3
        Demand=G1_poisson;
    case 4
        Demand=G1_exponential;
    case 5
        Demand=G1_sin;
end;

%Input Parameters
[Ph, Nitems, Ltime,
Rperiod,AverageWeeklyDemand,averagepurchasingquantity,MaxWeeklyDemand,M
inWeeklyDemand,AnnualAverageDemand,q1,q2] ...
= textread('parameters.dat','%d %d %d %d %d %d %d %d %d %d %d', 1)
SS=AverageWeeklyDemand*2.5;
s= AverageWeeklyDemand * Ltime +SS;
inventoryFIScase1_2;

%Cost Input
load kj.dat
load hj.dat
load cj.dat
load gj.dat

%proportion for 4 items
PIronOre=1;
PCoke=0.24;
Plimestone=0.084;
PCoalPowder=0.06;

%(s,S) policy
%Initialize
Co=zeros(1,Ph);
Ch=zeros(1,Ph);
Cp=zeros(1,Ph);

```

```

Cs=zeros(1,Ph);
Col=zeros(1,Ph);
Ch1=zeros(1,Ph);
Cp1=zeros(1,Ph);
Cs1=zeros(1,Ph);
Co2=zeros(1,Ph);
Ch2=zeros(1,Ph);
Cp2=zeros(1,Ph);
Cs2=zeros(1,Ph);
Co3=zeros(1,Ph);
Ch3=zeros(1,Ph);
Cp3=zeros(1,Ph);
Cs3=zeros(1,Ph);

CTj=zeros(1,Ph);
CTj1=zeros(1,Ph);
CTj2=zeros(1,Ph);
CTj3=zeros(1,Ph);
CTU=zeros(1,Ph);

%Initialize the times of order, mean, shortage....
OTj=zeros(1,Nitems);
AAIj=zeros(1,Ph);
STj=zeros(1,Nitems);
SPj=zeros(1,Nitems);
FP=0;
Q=zeros(1,Ph);
S=zeros(1,Ph);
Q1=zeros(1,Ph);
S1=zeros(1,Ph);
Q2=zeros(1,Ph);
S2=zeros(1,Ph);
Q3=zeros(1,Ph);
S3=zeros(1,Ph);
Q(1)=0;
S(1)=SS*(1+5/100);

%EXECUTING THE PROGRAM!!!
for i=1:(Ph-Ltime)
    if i<Ltime
        S(i+1)=S(1);
    else
        S(i+1)=S(i)+Q(i-Ltime+1)-Demand(i+1);
    finv=S(i)-(Ltime*AverageWeeklyDemand)+sum(Q(i+1:i+(Ltime-1)));
    if finv<s
        OTj(1)=OTj(1)+1;
        if finv<(SS*(1+5/100))
            STj(1)=STj(1)+1;
        end
        Q(i+1)=ceil(-finv+s+Demand(i+1));
        elseif 1<Q(i)<q1
            Cp(i)=Q(i)*cj(1);
        elseif q1<Q(i)<q2
            Cp(i)=Q(i)*cj(1)*(95/100);
        else q1<Q(i)<q2
            Cp(i)=Q(i)*cj(1)*(90/100);

```

```

        Q(i)=0;
        end;
    end
end;

    for i=1:(Ph)
        S1(i)=PCoke*S(1,i);
        Q1(i)=PCoke*Q(1,i);
    end;
    for i=1:(Ph)
        S2(i)=Plimestone*S(1,i);
        Q2(i)=PCoke*Q(1,i);
    end;
    for i=1:(Ph)
        S3(i)=PCoalPowder*S(1,i);
        Q3(i)=PCoke*Q(1,i);
    end;

    Co(i)=kj(1)*OTj(1);

    for i=1:(Ph)
        Ch(i)=S(i)*hj(1);
    end;

    for i=1:(Ph)
        if Q(i)<SS*(1+5/100)
            Cs(i)=Q(i)*gj(1);
        end;
    end;

    for i=1:(Ph)
        CTj(i) = Co(i)+sum(Ch(:))+sum(Cp(:))+sum(Cs(:));
    end;

        Col(i)=kj(2)*OTj(1);

    for i=1:(Ph)
        Ch1(i)=S1(i)*hj(2);
    end;
    for i=1:(Ph)
        Cs1(i)=Q1(i)*gj(2);
    end;

    for i=1:(Ph)
        CTj1(i) = Col(i)+sum(Ch1(:))+sum(Cp1(:))+sum(Cs1(:));
    end;

        Co2(i)=kj(3)*OTj(1);

    for i=1:(Ph)
        Ch2(i)=S2(i)*hj(3);
    end;
    for i=1:(Ph)
        Cs2(i)=Q2(i)*gj(3);
    end;

    for i=1:(Ph)

```

```

    CTj2(i) = Co2(i)+sum(Ch2(:))+sum(Cp2(:))+sum(Cs2(:));
end;

    Co3(i)=kj(4)*OTj(1);

for i=1:(Ph)
    Ch3(i)=S3(i)*hj(4);
end;
for i=1:(Ph)
    Cs3(i)=Q3(i)*gj(4);
end;

for i=1:(Ph)
    CTj3(i) = Co3(i)+sum(Ch3(:))+sum(Cp3(:))+sum(Cs3(:));
end;

for i=1:(Ph)
    temp=0;
    for j=1:(i)
        temp=temp+CTj(i)+CTj1(i)+CTj2(i)+CTj3(i);
        CTU(i)=temp;
    end;
end;

%%%%%%%%%%%%%%%%%%%%%%%%%%%%%%%%%%%%%%%%%%%%%%%%%%%%%%%%%%%%%%%%%%%%%%%%
%Fuzzy inventory
FuzzCo=zeros(1,Ph);
FuzzCh=zeros(1,Ph);
FuzzCp=zeros(1,Ph);
FuzzCs=zeros(1,Ph);
FuzzCo1=zeros(1,Ph);
FuzzCh1=zeros(1,Ph);
FuzzCp1=zeros(1,Ph);
FuzzCs1=zeros(1,Ph);
FuzzCo2=zeros(1,Ph);
FuzzCh2=zeros(1,Ph);
FuzzCp2=zeros(1,Ph);
FuzzCs2=zeros(1,Ph);
FuzzCo3=zeros(1,Ph);
FuzzCh3=zeros(1,Ph);
FuzzCp3=zeros(1,Ph);
FuzzCs3=zeros(1,Ph);
FuzzCTj=zeros(1,Ph);
FuzzCTj1=zeros(1,Ph);
FuzzCTj2=zeros(1,Ph);
FuzzCTj3=zeros(1,Ph);
FuzzCTU=zeros(1,Ph);
FuzzOTj=zeros(1,Nitems);
FuzzAAIj=zeros(1,Ph);
FuzzSTj=zeros(1,Nitems);
FuzzSPj=zeros(1,Nitems);

%%%%%%%%%%%%%%%%%%%%%%%%%%%%%%%%%%%%%%%%%%%%%%%%%%%%%%%%%%%%%%%%%%%%%%%%
%Initialize
FuzzSS=AverageWeeklyDemand*2;
FuzzSS1=AnnualAverageDemand*2;
FuzzQ=zeros(1,Ph);

```

```

FuzzS=zeros(1,Ph);
FuzzQ1=zeros(1,Ph);
FuzzS1=zeros(1,Ph);
FuzzQ2=zeros(1,Ph);
FuzzS2=zeros(1,Ph);
FuzzQ3=zeros(1,Ph);
FuzzS3=zeros(1,Ph);
FuzzQ(1)=0;
FuzzS(1)=FuzzSS*(1+5/100);%

%EXECUTING THE PROGRAM!!!
for i=1:(Ph-Ltime)
    if i<=Ltime
        FuzzS(i+1)=S(1);
    else
        FuzzS(i+1)=FuzzS(i)+FuzzQ(i-Ltime+1)-Demand(i+1);
    end
    if FuzzS(i+1)<0
        FuzzS(i+1)=FuzzS(i)+SS;
    end

Fuzzfinv=FuzzS(i)-(Ltime*AverageWeeklyDemand)+sum(FuzzQ(i:i+(Ltime-1)));

    if Fuzzfinv<s
        FuzzOTj(1)=FuzzOTj(1)+1;
        if Fuzzfinv<FuzzSS*(1+5/100)
            FuzzSTj(1)=FuzzSTj(1)+1;
        end
        FuzzQ(i+1)=ceil(-evalfis([Fuzzfinv
Demand(i)],A)+s+Demand(i+1));

        if FuzzS(i+1)>s+SS
            FuzzS(i+1)=s+SS;
        elseif 1<FuzzQ(i)<q1
            FuzzCp(i)=FuzzQ(i)*cj(1);
        elseif q1<FuzzQ(i)<q2
            FuzzCp(i)=FuzzQ(i)*cj(1)*(95/100);
        else q1<FuzzQ(i)<q2
            FuzzCp(i)=Q(i)*cj(1)*(90/100);
            FuzzQ(i)=0;
        end;
    end
end;

for i=1:(Ph)
    FuzzS1(i)=PCoke*FuzzS(1,i);
    FuzzQ1(i)=PCoke*FuzzQ(1,i);
end;
for i=1:(Ph)
    FuzzS2(i)=Plimestone*FuzzS(1,i);
    FuzzQ2(i)=PCoke*FuzzQ(1,i);
end;
for i=1:(Ph)
    FuzzS3(i)=PCoalPowder*FuzzS(1,i);
    FuzzQ3(i)=PCoke*FuzzQ(1,i);

```



```

end;

FzzuCo(i)=kj(1)*FuzzOTj(1);

for i=1:(Ph)
    FuzzCh(i)=FuzzS(i)*hj(1);
end;

for i=1:(Ph)
    if FuzzQ(i)<SS*(1+5/100)
        FuzzCs(i)=FuzzQ(i)*gj(1);
    end;
end;

for i=1:(Ph)
    FuzzCTj(i) = FuzzCo(i)+sum(FuzzCh(:))+sum(FuzzCp(:))+sum(FuzzCs(:));
end;

FzzuCol(i)=kj(2)*FuzzOTj(1);
for i=1:(Ph)
    FuzzCh1(i)=FuzzS1(i)*hj(2);
end;
for i=1:(Ph)
    FuzzCs1(i)=FuzzQ1(i)*gj(2);
end;
for i=1:(Ph)
    FuzzCTj1(i) =
FuzzCol(i)+sum(FuzzCh1(:))+sum(FuzzCp1(:))+sum(FuzzCs1(:));
end;

FzzuCo2(i)=kj(3)*FuzzOTj(1);
for i=1:(Ph)
    FuzzCh2(i)=S2(i)*hj(3);
end;
for i=1:(Ph)
    FuzzCs2(i)=Q2(i)*gj(3);
end;
for i=1:(Ph)
    FuzzCTj2(i) =
FuzzCo2(i)+sum(FuzzCh2(:))+sum(FuzzCp2(:))+sum(FuzzCs2(:));
end;

    FzzuCo3(i)=kj(3)*FuzzOTj(1);

for i=1:(Ph)
    FuzzCh3(i)=FuzzS3(i)*hj(4);
end;
for i=1:(Ph)
    FuzzCs3(i)=FuzzQ3(i)*gj(4);
end;
for i=1:(Ph)
    FuzzCTj3(i) =
FuzzCo3(i)+sum(FuzzCh3(:))+sum(FuzzCp3(:))+sum(FuzzCs3(:));
end;

for i=1:(Ph)
    temp=0;

```

```

    for j=1:(i)
        temp=temp+FuzzCTj(i)+FuzzCTj1(i)+FuzzCTj2(i)+FuzzCTj3(i);
        FuzzCTU(i)=temp;
    end;
end;

xtime=zeros(1,Ph);
for i=1:(Ph)
    xtime(i)=i;
end;

% some result
OTj
FuzzOTj

STj
FuzzSTj

SPj=STj(1:1)/52
FuzzSPj=FuzzSTj(1:1)/52

CTj=[CTj(52),CTj1(52),CTj2(52),CTj3(52)]
FuzzCTj=[FuzzCTj(52),FuzzCTj1(52),FuzzCTj2(52),FuzzCTj3(52)]

AAIj=mean(S+S1+S2+S3)
FuzzAAIj=mean(FuzzS+FuzzS1+FuzzS2+FuzzS3)
AAIP=(AAIj-FuzzAAIj)/FuzzAAIj

% Plot order, inventory, cost.....
figure;
subplot 211;plot(xtime,Q,'r-',xtime,FuzzQ,'b-');title('Order');
legend('classical','fuzzy ');
subplot 212;plot(xtime,S,'r-',xtime,FuzzS,'b-');title('Inventory');
legend('classical','fuzzy ');

figure;
plot(xtime,CTU,'r-',xtime,FuzzCTU,'b-');title('Annual Cost');
xlabel('week')
legend('classical','fuzzy ');

figure;
plot(CTU,S,'r-',FuzzCTU,FuzzS,'b-');title('Annual Cost');
xlabel('Inventory')
legend('classical','fuzzy ');

```

Appendix 6.2. Demand distribution (distribution_data_gyu.m)

```

% Disintegrates amount into distributions, then adds noise
clc;

```

```

clear all;
FA=3500000;

mu=26;
sigma=12;
week_number=52;
x=linspace(1,52,week_number);
g=pdf('Normal',x,mu,sigma);

g_uniform=unidpdf(x,week_number);

lambda=5;
g_poisson=poisspdf(x,lambda);

gama=15;
g_exponential=exppdf(x,gama);

AverageWeeklyDemand=67500; SS=AverageWeeklyDemand*2;S(1)=SS*(1+5/100);
g_sin=sin(x/(2*pi))+S(1);

A_normal=FA/intertation_gyu(x,g,x(1),x(length(x)));
A_uniform=FA/intertation_gyu(x,g_uniform,x(1),x(length(x)));
A_poisson=FA/intertation_gyu(x,g_poisson,x(1),x(length(x)));
A_exponential=FA/intertation_gyu(x,g_exponential,x(1),x(length(x)));
A_sin=FA/intertation_gyu(x,g_sin,x(1),x(length(x)));

G=A_normal.*g;
G_uniform=A_uniform.*g_uniform;
G_poisson=A_poisson.*g_poisson;
G_exponential=A_exponential.*g_exponential;
G_sin=A_sin.*g_sin;
%Check if area = Actual demand from company
delta_sum=[];
delta_sum_uniform=[];
delta_sum_poisson=[];
delta_sum_exponential=[];
delta_sum_sin=[];
for i=1:week_number-1
    delta_sum=[delta_sum,G(i)*abs(x(i+1)-x(i))];
    delta_sum_uniform=[delta_sum_uniform,G_uniform(i)*abs(x(i+1)-
x(i))];
    delta_sum_poisson=[delta_sum_poisson,G_poisson(i)*abs(x(i+1)-
x(i))];
    delta_sum_exponential=[delta_sum_exponential,G_exponential(i)*abs(x(i+
1)-x(i))];
    delta_sum_sin=[delta_sum_sin,G_sin(i)*abs(x(i+1)-x(i))];
end
integration=sum(delta_sum);
integration_uniform=sum(delta_sum_uniform);
integration_poisson=sum(delta_sum_poisson);
integration_exponential=sum(delta_sum_exponential);
integration_sin=sum(delta_sum_sin);

%Add noise

```

```

B=0.10;
deltaB_G=B*(rand(1,week_number)-0.5).*G;
deltaB_uniform=B*(rand(1,week_number)-0.5).*G_uniform;
deltaB_poisson=B*(rand(1,week_number)-0.5).*G_poisson;
deltaB_sin=B*(rand(1,week_number)-0.5).*G_sin;
deltaB_exponential=B*(rand(1,week_number)-0.5).*G_exponential;
G1_normal=deltaB_G+G;
G1_uniform=deltaB_uniform+G_uniform;
G1_poisson=deltaB_poisson+G_poisson;
G1_exponential=deltaB_exponential+G_exponential;
G1_sin=deltaB_sin+G_sin;

```

Appendix 6.3. Integration distribution to actual demand (intertation_gyu.m)

```

% Calculate integration
function intergration_y=intertation(x,y,a1,a2)
x_length=length(x);
[I1,J1,X1]=find(x==floor(a1));
[I2,J2,X2]=find(x==floor(a2));
delta_sum_y=[];
for i=J1:J2-1
    delta_sum_y=[delta_sum_y,(x(i+1)-x(i))*y(i)];
end
intergration_y=sum(delta_sum_y);

```

Appendix 6.4. Fuzzy controller (inventoryFIScase1_2.m)

```

A=newfis('inventorycontrol');
% Set the scalar factor Xi,Xd,Xo
Xi=s;
Xd=2*(AverageWeeklyDemand); %s or
(AverageWeeklyDemand)*(Ltime)+((MaxWeeklyDemand)-(AverageWeeklyDemand))*(Ltime);
Xo=2*(averagepurchasingquantity);

% Add the first input variable
A=addvar(A,'input','FuzzS(i)',[SS Xi]);
A=addmf(A,'input',1,'med','trapmf',[3*Xi/10 Xi/2 Xi/2 7*Xi/10]);
A=addmf(A,'input',1,'high','trapmf',[6*Xi/10 7*Xi/10 Xi Xi]);
A=addmf(A,'input',1,'low','trapmf',[0 0 3*Xi/10 4*Xi/10]);
A=addmf(A,'input',1,'zero','trapmf',[0 0 0 0]);

% Add the second input variable
A=addvar(A,'input','demanddistributions(i)', [0 Xd]);
A=addmf(A,'input',2,'high','trapmf',[6*Xd/10 7*Xd/10 Xd Xd]);
A=addmf(A,'input',2,'med','trapmf',[3*Xd/10 Xd/2 Xd/2 7*Xd/10]);
A=addmf(A,'input',2,'low','trapmf',[0 0 3*Xd/10 4*Xd/10]);
A=addmf(A,'input',2,'zero','trapmf',[0 0 0 0]);

% Add the output variable
A=addvar(A,'output','Forder(i)',[0 Xo]);

```

```
A=addmf(A,'output',1,'high','trapmf',[6*Xo/10 7*Xo/10 Xo Xo]);
A=addmf(A,'output',1,'med','trapmf',[3*Xo/10 Xo/2 Xo/2 7*Xo/10]);
A=addmf(A,'output',1,'low','trapmf',[0 0 3*Xo/10 4*Xo/10]);
A=addmf(A,'output',1,'zero','trapmf',[0 0 0 0]);

% Add the rules
ruleList=[
3 3 3 1 1
3 2 2 1 1
3 1 1 1 1
1 3 3 1 1
1 2 1 1 1
1 1 1 1 1
2 3 3 1 1
2 2 2 1 1
2 1 1 1 1
1 4 4 1 1
2 4 4 1 1
3 4 4 1 1];
A=addrule(A,ruleList);
```