



Vaasan yliopisto
UNIVERSITY OF VAASA

Kecheng Zhao

**A Literature Review on the Application of
Acoustic Emission to Machine Condition
Monitoring**

School of Technology and Innovations
Master's thesis in Smart Energy
Master of Science in Technology

Vaasa 2021

UNIVERSITY OF VAASA**School of Technology and Innovations****Author:** Kecheng Zhao**Title of the Thesis:** A Literature Review on the Application of Acoustic Emission to Condition Monitoring**Degree:** Master of Science in Technology**Programme:** Smart Energy**Supervisor:** Professor Xiaoshu Lü, Professor Maciej Mikulski**Year:** 2021**Pages:** 83

ABSTRACT:

Acoustic emission (AE) is a common physical phenomenon, in which the strain energy is released in the form of elastic wave when a material is deformed or cracked during the stress process. The condition monitoring based on AE is a relatively new method that aims to use noise/vibration anomalies to detect machine failures. However, some challenges lie ahead of its application. This thesis aims to analyze the literature in the field of AE applications to machine condition monitoring. The principles of AE technology, relevant instruments, machine monitoring and AE signal analysis, and practical examples of AE monitoring applications will be presented. More specifically, challenges, solutions and future direction in solving signal noise and attenuation challenges will be discussed. Through the example of rotating machinery, the characteristics of AE will be explained in detail. This thesis lays the foundation for the actual use of AE to monitor and analyze the state of machinery and provides guideline for future data collection and analysis of AE signals.

KEYWORDS: acoustic emission, machine condition monitoring, signal analysis, rotary machine

CONTENTS

ABBREVIATIONS	5
LIST OF FIGURES	6
LIST OF TABLES	7
PREFACE	8
1 INTRODUCTION	9
1.1 Background	9
1.2 Aim of the thesis	9
2 ACOUSTIC EMISSION SIGNALS AND RELATED ATTENUATION	12
2.1 The principles of AE signals	12
2.2 The attenuation of AE signals	14
3 MONITORING OF ACOUSTIC EMISSION SIGNALS	17
3.1 Monitoring technique	17
3.2 Monitoring equipment	20
3.2.1 Equipment components	20
3.2.2 Equipment classification	22
3.2.3 Technical indications of equipment	28
3.2.4 Auxiliary equipment	30
3.2.5 Selection of AE testing instruments	33
3.3 Noise sources in AE measurements	35
3.4 Noise reduction methods of AE	37
4 ANALYSIS OF ACOUSTIC EMISSION SIGNALS	39
4.1 Parameter analysis of AE signal	39
4.1.1 Counting method	41
4.1.2 Energy and amplitude analysis method	42
4.1.3 Experience map analysis method	44
4.1.4 Distribution analysis method	44

4.1.5 Association analysis method	44
4.2 Spectrum analysis of AE signal	45
4.2.1 Classification of spectrum analysis	45
4.2.2 Principle of FFT-based analysis method	47
4.3 Wavelet analysis of AE signal	48
4.4 Neural network analysis of AE signal	51
4.4.1 BP neural network	52
4.4.2 Hamming neural network	53
4.4.3 RBF neural network	54
5 EXAMPLE OF FAULT DETECTION OF ROTARY MACHINE	57
5.1 Wind turbine major components and prevalent failures	57
5.2 Experiment results	58
5.2.1 Low speed test rig	59
5.2.2 Time domain statistical parameters	61
6 DISCUSSION	66
7 CONCLUSIONS	74
BIBLIOGRAPHY	76

ABBREVIATIONS

AE	Acoustic Emission
RMS	Root Mean Square
NDT	Non-destructive Testing
PCI	Peripheral Component Interconnect
USB	Universal Serial Bus
TCP/IP	Transmission Control Protocol/Internet Protocol
Wi-Fi	Wireless Fidelity
GPS	Global Positioning System
LAN	Local Area Network
PC	Personal Computer
CRT	Cathode Ray Tube
FFT	Fast Fourier Transform
AR	Autoregressive
MA	Moving average
ARMA	Autoregressive moving average
DFT	Discrete Fourier Transform
ANN	Artificial Neural Network
BP	Back Propagation
RBF	Radial basis function
PM	Preventive Maintenance
PdM	Predictive Maintenance
CBM	Condition-based Maintenance
PAC	Physical Acoustics Corporation
PXI	PCI extensions for Instrumentation

LIST OF FIGURES

Figure 1. The flowchart of the thesis.	11
Figure 2. Components of AE detector	21
Figure 3. Signal characteristic parameters	39
Figure 4. Wavelet transform tree.	49
Figure 5. Typical AE signals	50
Figure 6. Neuronic node diagram	52
Figure 7. Back propagation (BP) network structure	53
Figure 8. Hamming network structure	54
Figure 9. Radical Basis Function (RBF) network structure	55
Figure 10. The major component of a wind turbine	58
Figure 11. Test rig	59
Figure 12. PXI data acquisition system	60
Figure 13. Graphical illustration of the simulated incipient bearing outer race defect	60
Figure 14. Comparison of the vibration(a) and AE signal(b)	61
Figure 15. Comparison of the RMS trend of undamaged (a) and damaged (b) signals	62
Figure 16. Comparison of the skewness trend of undamaged (a) and damaged (b) signals	63
Figure 17. Comparison of the kurtosis trend of undamaged (a) and damaged (b) signals	64

LIST OF TABLES

Table 1. Factors influencing the intensity of AE signals.	13
Table 2. Comparison of the characteristics of AE testing and other non-destructive testing approaches for machine healthy monitoring	18
Table 3. Basic technical indicators of AE instruments	28
Table 4. Measuring system error of two sampling rates with different effective signal amplitudes	34
Table 5. Features and application of Some AE parameters	40

PREFACE

First and foremost, I would like to thank my supervisor Professor Xiaoshu Lü for giving me an interesting and contemporary topic: acoustic emission technology. I want to thank her for her valuable suggestions and guidance on many zoom conferences. This is very important for me to finish academic thesis in English for the first time. I would also like to thank the instructor Professor Maciej Mikulski for providing me with a lot of detailed suggestions for improvement in a timely manner. I would also like to thank Professor Hannu Laaksonen for providing me with information about thesis.

I also want to thank some close people in my life. My family have always believed in and supported me. They remind me of the progress of thesis every week. My friends, most of whom are connected through the Internet, have provided me as much physical and mental supports as possible. My seniors taught me their own master thesis experience and helped me improve my mentality. Finally, I also want to thank my godfather Hui Sun. Although he is often busy with work and business trips, he has been providing format and grammatical suggestions for the thesis content through WeChat and zoom.

1 INTRODUCTION

1.1 Background

Acoustic emission (AE) is a common physical phenomenon in which the strain energy is released in the form of elastic wave when a material is deformed or cracked during the stress process (Shen et al., 2003). German Kaiser (1953) was the first pioneer who observed the phenomenon that metal zinc, copper, aluminum and lead can generate AE and discovered the irreversibility of AE in 1950s. In the 1960s, the research on AE technology became popular in the US. Schofield (1961) believed that AE originated from the internal mechanism of the material. He found that the AE continuous signal is sensitive to the rate of change, which comes from dislocation pinning and cross-slip and the burst signal is related to the formation of stacking faults and the deformation mechanism of mechanical twins. Dunegan (1963) and other researchers increased the frequency of the AE experiment from 20hz-20khz to 100khz-1Mhz. These studies have created sufficient conditions for AE to move from laboratory to social practice. In 1964, the General Dynamics company applied the AE technology to the water pressure test of the Polaris missile shell. This is the first time that AE technology has been applied in operation activities. Since then, the AE technology has been widely used in commerce and developed from single sound channel to multi-channel. At present, the analysis process has evolved from simple signal processing to the use of computers for AE source positioning, waveform analysis, source feature analysis and pattern recognition (Gong&Yang, 2009).

1.2 Aim of the thesis

The condition monitoring based on AE is a relatively new method that aims to use noise/vibration anomalies to detect machine failures. Despite extensive research, AE signals are difficult to analyze due to the propagation, attenuation, dispersion, reflection, refraction and noises of the AE signal through the material. Therefore, its

application as a machinery operation monitoring technology has encountered many technical challenges in industries.

This thesis aims to analyze the literature in the field of AE applications to machine condition monitoring. The principles of AE technology, relevant instruments, machine monitoring and AE signal analysis, and practical examples of AE monitoring applications will be presented. More specifically, challenges, solutions and future direction in solving signal noise and attenuation challenges will be discussed. Through the example of rotating machinery, the characteristics of AE will be explained in detail. This thesis lays the foundation for the actual use of AE to monitor and analyze the state of machinery and provides guideline for future data collection and analysis of AE signals.

This thesis is structured as follows. Chapter 2 and Chapter 3 introduces AE technology and monitoring techniques. Chapter 4 focuses on analytical techniques. Chapter 5 refers to an experiment that uses parametric analysis to analyze AE signals. Chapter 6 presents some discussions, including noteworthy features, advantages and disadvantages of AE emission, current status and challenges. Chapter 7 concludes the thesis. Figure 1 shows the flowchart.

A Literature Review on the Application of Acoustic Emission to Machine Condition Monitoring

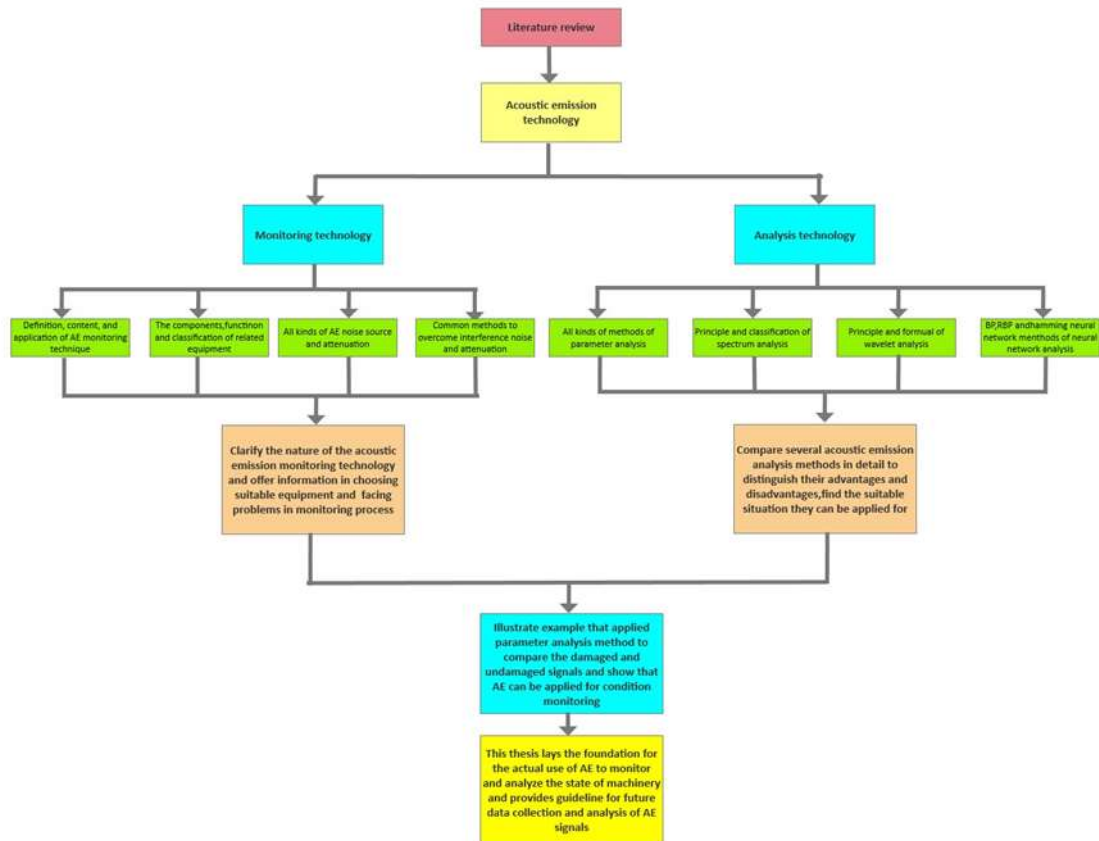

Figure 1. The flowchart of the thesis.

2 ACOUSTIC EMISSION SIGNALS AND RELATED ATTENUATION

2.1 The principles of AE signals

When a material or structure is subjected to external or internal force, due to the uneven microstructure and the existence of internal defects, it leads to local stress concentration and unstable stress distribution. When the strain energy in this unstable stress distribution state accumulates to a certain extent, the unstable high-energy state must transition to a stable low-energy state. This transition is completed in the form of plastic deformation, rapid phase change crack generation, development and fracture. In this process, strain energy is released. Part of it is elastic energy released quickly in the form of stress waves. This phenomenon of releasing strain energy in the form of elastic waves is called AE. (Li, 2001; Huang et al., 1998). AE signal is the electrical signal detected at a sensor, which is converted through the detection of AE wave (Ohtsu, 2010).

When local deformation occurs in a solid medium, the deformation in both volume and shear will appear, resulting in compression waves (longitudinal waves) and shear waves (transverse waves). These two waves propagate in the medium at different speeds. When encountering the interface of different media, the waves will be reflected and refracted. The propagation law of AE waves is closely related to the elastic properties and geometric shapes of solid media. In fact, the propagation of waves in solid media is accompanied by attenuation.

According to the characteristics of AE, AE signals are eventually divided into two types: burst and continuous signals (Inasaki, 1998). The burst signals of AE are composed of high-amplitude, incoherent signals with a duration of microseconds. It is mainly concerned with formation of stacking faults in the material, mechanical twins, formation of cracks and fracture process. The continuous signal of AE consists of a series of low-amplitude and continuous signals. This signal is sensitive to strain rate

and is mainly related to plastic deformation such as material dislocation and cross-slip. Factors that affect the intensity of AE are illustrated in Table 1.

Table 1. Factors influencing the intensity of AE signals.

Condition	Factors that produce high-intensity signals	Factors that produce low-intensity signals
Material characteristics (internal factors)	High-strength material Anisotropic material Uneven material Casting material Large grains Martensitic transformation Nuclear irradiated material	Low-strength materials Isotropic material Homogeneous material Forging material Fine grain Dispersive phase transition Non-nuclear irradiated materials
Experimental conditions (external factors)	High strain rate No preload Thick section Low temperature Corrosive medium	Low strain rate With preload Thin section high temperature No corrosive medium
Deformation and fracture mode (internal and external factors)	Twin deformation Cleavage fracture Defective material Crack propagation Composite fiber breakage	Non-twin deformation Shear fracture Defect-free material Plastic deformation Composite resin fracture
Instrument characteristics	Passband width Sensor response mode and frequency Total system gain Threshold voltage	

In general, AE is the result of the rapid unloading of local areas in the material and the release of elastic potential energy. The unloading time of the AE determines the frequency spectrum of the AE signal. The shorter the unloading time leads to the faster the energy released and the higher the frequency of the AE signal. For different materials and different forms of AE, the frequency ranges of AE signals are different and can be from infrasound and audio signals to ultrasonic signals of tens of megahertz.

The amplitude of the AE signal can range from microvolts to hundreds of volts. The elastic wave emitted from the AE source eventually propagates to the external of the material, which causes a surface displacement that can be monitored by the relevant transducer. The detector can collect an electrical signal which is converted from the mechanical vibration of the material. The signal will be recorded after processing such as enlargement, noise reduction.

2.2 The attenuation of AE signals

The propagation of waves in solid media is accompanied by attenuation phenomenon. Attenuation refers to the process in which the amplitude of the signal decreases as the distance from the sound source increases. It controls the detectability of the sound source distance and becomes a key factor in determining the distance between sensors. There are several main attenuations of wave propagation, including geometric attenuation; dispersion attenuation; scattering and diffraction attenuation; attenuation caused by energy loss mechanisms.

When a wave is generated by a local source, the wave will propagate in all directions from the source. It is supposed in a lossless medium that the energy of the entire wavefront remains constant. As the propagation distance of the wave increases, the amplitude of the wave must decrease when scattered waves are on the entire wavefront sphere (Ni& Iwamoto, 2002). The process is call geometric attenuation.

Material attenuation is caused by friction within the material. If the solid is an elastic medium, the total mechanical energy of the AE wave remains unchanged. However, in the actual medium, mechanical energy is converted into thermal energy due to the thermoelastic effect caused by the internal friction of the particle vibration. If the stress exceeds the elastic limit of the medium, plastic deformation will also cause the loss of mechanical energy. Crack propagation converts the mechanical energy of the wave into new surface energy. The interaction of dislocations in the wave medium can also cause energy loss and attenuation. The viscous behavior of plastic materials and

the friction between the interface and the incompletely combined inclusions or fibers in the composite material will cause the energy loss and attenuation of the wave. The interaction of magneto-elastic, the interaction of electrons in metals and the spin mechanism of paramagnetic electrons or nucleons can cause energy loss and attenuation of waves. The mechanical energy loss caused by the above-mentioned mechanisms will cause Bohr to drastically drop as the wave passes through the medium (Asamene & Sundaresan, 2015).

Dispersion is a phenomenon caused by the change of wave speed with frequency in some physical systems. The cause of dispersion may be geometric boundary conditions (waveguide, shallow water) or the interaction between the wave and the transmission medium. Elementary particles (considered as matter waves) have non-trivial dispersion relations even in the absence of collective constraints and the presence of other media (Aggelis & Matikas, 2012).

Scattering is the phenomenon that when the surface of the object irradiated by the projected wave has a large curvature or even is not smooth, the secondary radiation wave diffuses and distributes in the angular domain according to a certain rule. Diffraction refers to the physical phenomenon that waves propagate away from the original straight line when encountering obstacles. Wave propagation in media with complex boundaries or discontinuities, such as cavities, cracks and inclusions will interact with these media, which causes scattering and diffraction phenomena (Muravin, 2009).

There are many other factors that can also cause attenuation. When the AE wave propagates toward adjacent medium, the amplitude of wave will therefore decrease, just like water medium in the container. Obstacles in the container to be measured can also cause the amplitude of the wave to decrease, such as takeovers on containers, manholes.

In the actual structure, all the above-mentioned attenuation in the propagation of the AE signal will happen and attenuation can only be measured experimentally. To reduce the impact of attenuation, measures including reducing the sensor frequency or sensor spacing are taken. For example, a 150kHz high-frequency sensor is usually used for local monitoring of composite materials, while a 30kHz low-frequency sensor is used for large-area monitoring. When the overall monitoring of large components is required, the number of sensors will be increased accordingly.

3 MONITORING OF ACOUSTIC EMISSION SIGNALS

3.1 Monitoring technique

AE monitoring is one of the most efficient process monitoring techniques available (Watson et al., 2014). The elastic wave emitted by the AE source travels through the medium and reaches the surface of the machine to be tested, causing mechanical vibration on the surface. The transient displacement of the surface is converted into an electrical signal by the AE sensor and the characteristic parameters are formed after amplifying and processing. Finally, the characteristics of the AE source and materials are evaluated and interpreted. All currently available methods of AE monitoring can be classified as signal-based (compare calculated signal values to predefined signal values), model-based (develop process models through experience or physical relationships), or classification-based (Method of determining feature vector from a certain type of quality feature) (Tönshoff et al., 2000). The object of most signal processing methods is one or more of the following: to develop a suitable "process model" from which the effect of certain variables can be determined; from sensor data to produce information that can be used to assess the state of process features or to generate data features for the purpose of monitoring changes in the output of process (Dornfeld, 1994).

During the propagation of the cracks in materials and tools, blast style fracturing and chipping can be observed. The primary objective of AE signal processing is to eliminate superfluous noise and extract characteristic signals that are unique to the target process parameters. Compared to other non-destructive testing methods, AE showed some unique characteristics in the applications in the Table 2. The main reason of using AE to monitor processing operations is that the frequency spectrum of an AE signal is far greater than that of machine vibration and ambient noise. (Dornfeld, 1984). Additionally, it does not obstruct the cutting process. AE signals with varying degrees of intensity indicate the contact area and deformation area during the cutting process, establishing themselves as a fundamental tool for process monitoring. The friction

between the tool/workpiece will produce a continuous AE signal, which provides a wealth of information for the cutting process. Methods have been created to monitor tool wear during turning (Liu&Dornfeld, 1996), milling (Lou&Lee, 1995), drilling (Ravishankar&Murthy, 2000), boring (Li&Wu, 2000), grinding (Webster et al., 1994) and forming (Brankamp, 1996). To assess the bandwidth needed for a particular process configuration, the AE signal and Root Mean Square (RMS) of the AE may be monitored and compared to the nominal value in order to detect irregular events such as tool damage (Guo&Ammula, 2005) or unacceptable tool wear (Pruitt&Dornfeld, 1996).

Table 2. Comparison of the characteristics of AE testing and other non-destructive testing approaches for machine healthy monitoring

	AE testing	Other Non-destructive testing
Testing Object	Growth or changes of defects	Existence of defects
Factors	Applied force	Shape of defect
Sensitivity to materials	High	Low
Sensitivity to geometry	Low	High
Requirements for entering the testing objects	Few	Many
Test Range	Overall monitoring	Partial scan
Main problems	Noise, attenuation, specification	Geometry, material

With the advancement of modern power electronic and computer technology, as well as the enhancement of anti-interference capability and reliability of AE equipment, the accuracy of AE technology in monitoring has steadily improved. The volume and quality of related equipment have been reduced after generations and the portability has also been improved. These factors promoted the widespread use of AE monitoring in various fields.

At present, AE monitoring is used in different fields, including the following aspects:

- (1) Petrochemical industry: monitoring and structural integrity assessment of cryogenic vessels, spherical vessels, cylindrical vessels, high-temperature reactors,

towers, heat exchangers and pipelines; Leak detection of the bottom of atmospheric storage tanks; leak detection of buried pipelines; real-time monitoring of corrosion status; structural integrity monitoring of offshore platforms and internal monitoring of coastal pipelines (Drouillard, 1994; Sato, 1996; Meylan et al., 2021).

- (2) Power industry: monitoring of partial discharge of transformers; continuous and intermittent monitoring of steam pipelines; quantitative testing of valve steam loss; monitoring of high-pressure vessels and steam drums; continuous leakage monitoring of steam pipelines; monitoring of boiler leakage; steam turbine blades and bearings monitor (T. Kishi, 1994; Runow, 1985; Nazarchuk et al., 2017).
- (3) Material testing: performance testing of composite materials, reinforced plastics, ceramics and metal materials; friction and fracture testing of materials; fatigue testing and corrosion monitoring of metal and alloy materials; hydrogen embrittlement monitoring of high-strength steel (Sachse, 1994; Fowier, 1986; Benz, 1996; Fowler, 1979).
- (4) Aerospace and aviation industry: aircraft aging test; complete structure and aircraft fatigue test; corrosion detection under the wing skin; in-situ monitoring of aircraft landing gear; monitoring of engine blades and helicopter blades; online continuous monitoring of aircraft; aircraft shells Body geese falling and breaking detection; aircraft verification test; helicopter gearbox speed change process test; space rocket launcher structure verification test (Zhang, 2004; Bhuiyan et al., 2018).
- (5) Metal processing industry: monitoring of tool wear and fracture; monitoring of contact between grinding wheels or shaping devices and workpieces; verification of repair and shaping; quality control of metal processing; vibration detection; forging testing; monitoring and prevention of collisions during processing (Maddox, 1991).
- (6) Transportation industry: monitoring and defect location of long tube trailers, road and railway tank cars; crack detection of railway materials and structures; structural integrity testing of bridges and tunnels; condition monitoring of ball

bearings and journal bearings of trucks and trucks; trains Break detection of wheels and bearings (Gorman, 1991).

- (7) Other fields: interference detection of hard disks; integrity detection of pressurized bottles; mechanical wear and friction monitoring; generator status monitoring; online process detection of rotating machinery; crack detection of rigid rolls; monitoring of automobile bearing strengthening process; monitoring of casting process (Li, 2001).

In addition to these fields, AE monitoring has also been tested in many studies due to its advantages and will also be practically used in more areas.

3.2 Monitoring equipment

3.2.1 Equipment components

The AE detector is composed of 4 parts: sensor, preamplifier, data acquisition and processing system and record analysis display system which are shown in Figure 2 (Planes et al., 2013). The sensor in the AE instrument detects and gathers the AE wave signal emitted by the AE source, that is, the AE signal. After the signal is amplified by preamplifier, it is processed by the signal acquisition and processing system. Finally, the record and display system perform record analysis and display to achieve the purpose of detecting the AE source. Almost all AE instruments have these 4 parts. Only some will merge certain parts together, such as AE sensors with built-in amplifiers, hand-held AE meters that integrate amplifiers, data acquisition and processing, and record analysis and display.

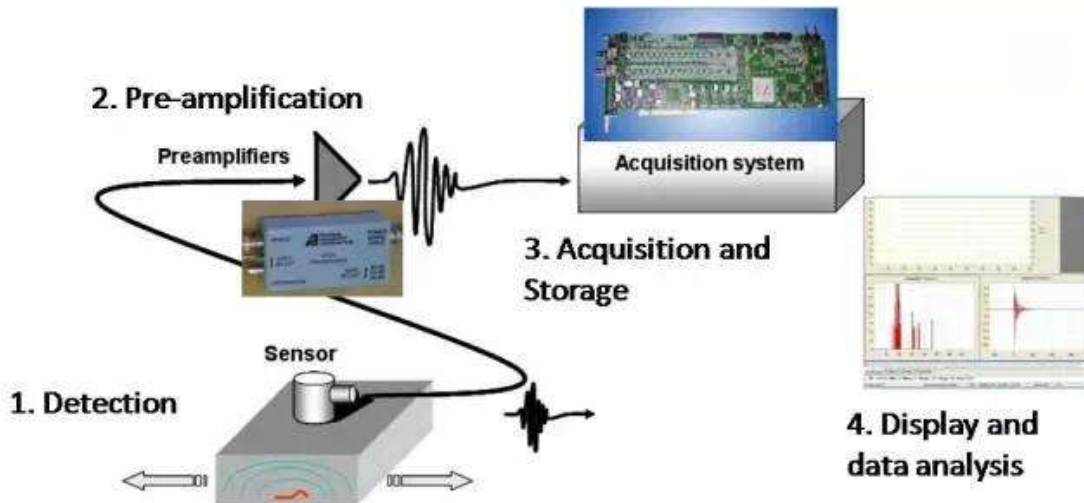

Figure 2. Components of AE detector

The function of the sensor is to convert the received acoustic signal of AE obtained into a corresponding electrical signal.

Typically, the amplifier attached to the sensor is referred to as a preamplifier. Its main function is to amplify or improve the driving capability of the AE emission electrical signal with weak driving capability output by the sensor so that it can become the AE electrical signal that can be transmitted remotely and received by the data acquisition system. The preamplifier also often has the function of an analog signal filter and the function of transmitting a calibration AE signal. The preamplifier may be integrated into the sensor or the data acquisition system, such as a wireless AE acquisition module/handheld AE system, depending on the needs of the data acquisition and processing system. It can also be independently externally placed between the sensor and the data acquisition system and connected by a cable.

Data acquisition and processing systems generally integrate multiple acquisition cards. Each acquisition card will have multiple independent channels. According to the sampling frequency, the acquisition card usually has different models such as 40MHz, 10MHz and 5MHz. The sampling accuracy often has different models such as 18bit and 16bit. The workflow of capture card is divided into modules such as analog signal

conditioning, analog filtering, touch/digital conversion, digital signal processing, and communication. The function of the analog signal conditioning circuit is to adjust the analog signal input by the preamplifier into a signal that can be input by the analog-to-digital conversion circuit through signal amplification, reduction, impedance transformation, and filtering. The main functions of digital signal processing are digital filtering, spectrum analysis, parameter extraction.

The record analysis display system is usually composed of a computer and special AE software. Computer options include laptops and desktops.

3.2.2 Equipment classification

The data acquisition and processing system is changes and develops rapidly, which is also the main part that determines the main functional performance of the AE instrument. AE instruments are classified mainly by the structure and content of the data acquisition and processing system. Classifications by communication architecture, connection architecture, processing functions and computer software are common in practice.

Usually, AE instruments are classified by communication architecture.

- (1) Using Peripheral Component Interconnect (PCI) interface communication. In the last century, shortly after the introduction of computer technology for AE detectors, PCI interface AE detectors immediately became the mainstream architecture. One way of this structure is to insert the AE capture card directly into the PCI slot of the computer motherboard. In the period when desktop computers were the mainstream, this enabled the instrument to have better integration. Another way is to use the PCI bus expansion connection to insert the AE acquisition card on the expansion PCI board with a separate chassis. This can solve the problem of insufficient PCI slots in the computer itself.

- (2) Using Universal Serial Bus (USB) interface for communication. Since 2007, when the first USB2.0 multi-channel digital AE system in the world was created, the USB2.0 multi-channel digital AE instrument has increased the rate at which measured data is transmitted. It can be directly connected to a laptop computer and the number of channels is not limited by the number of slots in the computer box. It has replaced a certain number of original desktop computer slot PCI architecture AE meters and has become the main communication interface of the multi-channel digital AE instrument as well as the future technological development direction of various manufacturers.
- (3) Using network interface communication. The data communication based on Transmission Control Protocol/Internet Protocol (TCP/IP) connecting the data acquisition and processing device with a computer network interface can realize the connection between the data acquisition and processing device and the computer at any distance. The connecting components use five types of twisted-pair cables, network switches, optical fibers, and optical transceivers. Based on the network interface data communication, the data collection moved to the sensor or even integrated with the sensor to form an intelligent digital sensor system will be more applied to meet the needs of data communication transmission using network/wireless/optical fiber. It also meets the application requirements of distributed remote control and telemetry.
- (4) Using Wireless Fidelity (Wi-Fi) wireless interface. The characteristic of the line AE instrument is that there is no need to drag a long cable. The wireless communication distance is usually several kilometers, and the installation of the cable of the wired AE instrument is heavy and the cable length is usually only allowed to be 50 meters, or the maximum is within a hundred meters. This makes the wireless AE instrument the only choice for AE applications that cannot use wired cable AE instruments such as rotating devices, bridges, wind power, mining equipment, and civil geological inspections. It has also become the choice for traditional wired cable AE applications, but the data volume is not large, and it is hoped that the tedious work of installing cables can be avoided. The wireless AE

instrument has a low data throughput rate of only tens of thousands of AE impact parameter sets per second, which is far lower than the hundreds of thousands of AE impacts per second of the wired cable AE instrument. This makes it impossible to use wireless acoustic transmitters on many occasions where the amount of data is large and data loss is not allowed. In addition, the time difference measurement of the wireless acoustic transmitter is completed by Global Positioning System (GPS) signals. The requirement for good GPS signal conditions also limits the application of some wireless acoustic transmitters that can also perform the time difference positioning function when there is no GPS signal condition.

- (5) Using ZigBee wireless interface. The most advanced 2.4G frequency communication bandwidth is 250Kbps. Due to bandwidth limitations, it is generally used for single-channel wireless AE instruments.

Classification by connection architecture between channels is listed as followed:

- (1) Single-channel handheld AE detection instrument: The single-channel handheld AE instrument integrates all components such as pre-amplifier, acquisition card, and computer into one chassis. It is portable, hand-held operated and battery powered, which becomes a special AE instrument for rapid diagnosis of valve leakage and fault diagnosis.
- (2) Multi-channel centralized AE detection instrument: The centralized AE detection instrument concentrates all the acquisition cards into one main board or several main boards with synchronization relationship. This is the main instrument architecture of each manufacturer. Many AE applications require a larger detection area and require multiple AE sensors to meet the requirements. Therefore, the multi-channel AE instrument is still the main choice for many AE applications.
- (3) Multi-channel set distributed AE detection instrument: The distributed AE detector is composed of multiple independent single-channel AE collectors and a

computer to form a multi-channel real-time AE acquisition system. It is evolved from the wireless multi-channel AE acquisition system. Multiple independent AE collectors establish a communication connection with a computer through wired and wireless network switches and remote Wi-Fi or Local Area Network (LAN) to form a multi-channel acquisition system. It collects the AE data according to the conditions set by the Personal Computer (PC) software and transmits the data to the remote monitoring terminal PC. The data time synchronization between each collector is realized by receiving GPS time or connection synchronization.

Classification of processing functions of data acquisition and processing systems is also of significance. The digital AE instruments and full-waveform AE instruments are two main types of processing functions. The main difference of them is whether the AE parameters are generated by the hardware of the data acquisition system or by the software of the host computer. Digital signal processing is the main difference between the AE data acquisition system and the general data acquisition system. Its function is to calculate and process the amplitude, count, duration and other AE parameters of small data volume based on the digital AE waveform signal of large data volume. The data volume can be reduced by thousands of tens of times. Besides the function in parameter generation of the AE, digital signal processing can also provide real-time continuous digital filter, spectrum analysis, waveform before and after sampling, and threshold triggering, which is greatly improves the ability of AE detection.

Most practical AE applications require that no signal loss is allowed for any period of time, such as missed detection of signal loss at the moment of cracking. The data throughput rate of ordinary computers and data acquisition systems cannot yet meet the requirement of non-loss transmission of large data volume waveform data of AE signals. To avoid data loss over time, the digital parameters of AE instrument are created by hardware. The data acquisition unit performs continuous real-time signal processing on the large data volume waveform data, extracts the AE parameter data

converted into a small data volume and then transmits it to the computer. This kind of data compression ensures that the signal is not lost and contains information at any time.

If the sampling speed is 10M, the sampling accuracy is 16 bits and the number of channels is 4, the waveform data volume will be $10\text{MHz} \times 4 \text{ channels} \times 16 \text{ bits} = 640\text{Mbit/s}$. For the PCI bus with a bandwidth of 133Mbit/s and the USB2.0 interface with a bandwidth of 480Mbit/s, this amount of data has exceeded the limit of the pass rate and all the waveform uploads inevitably cause data loss. Especially for the PCI bus, it must also meet the bandwidth occupation of the network and hard disk control cards. The data pass rate of the actual data acquisition system is much lower than the theoretical data pass rate.

The principle of generating parameters of waveform data and reducing the amount of data is to convert a digital waveform signal into a digital waveform envelope. It uses the amplitude, duration, rise time, arrival time and other envelope AE parameter expressions to describe the AE signal instead of describing the AE signal with the digital waveform. The impact of characteristic parameter duration of AE is typically 0.1-2ms. The maximum impact frequency of each channel will not exceed 10KHz. By replacing each impact waveform with refined parameters, the 4-channel acquisition instrument will not generate more than 40KHz of parameters when the AE signal has a large amount of data. The parameter of each impact generally does not exceed 100 bytes (800bit). In this way, the parameter data of the 4-channel acquisition system occupies a bandwidth of 32 Mbit/s at most. The amount of data is compressed to 1/20 of the original waveform data to ensure that it will not be lost. For most large-scale component engineering applications, the frequency of impact will decrease geometrically. The data compression ratio will be further increased to 1/1000 level. This ensures that even if the number of channels of the acquisition system is increased to more than 100 channels, there is no need to worry about the loss of data transmission. Ensuring no missed inspection is a necessary requirement for most AE

applications. The majority of commercial AE instruments on the market are digital AE instruments that use hardware to generate AE parameters.

The full waveform AE instrument uses a general data acquisition device to first transmit the waveform data to the computer. Then the computer software generates the AE parameters (amplitude, etc.). The generation of parameters (amplitude, etc.) in this way requires a large amount of waveform data to be sent to the computer first. This will be limited by the bottleneck of computer communication capabilities and is not suitable for multi-channel applications with high sampling rates. Under the situation that the amount of data is large and data loss is not allowed, such as the AE detection of large engineering structures, a full-wave system cannot guarantee data integrity when many AE events may occur at a certain instant. There is a possibility of data loss. The instruments of major instrument manufacturers can only guarantee that the data of 5M sampling rate, 16-bit precision and 2 channels are not lost. A problem encountered in full waveform acquisition is the capacity of the hard disk. For the 40MB/s upload rate of the USB2.0 architecture AE instrument, 160GB of data per hour will be generated. A 1TB mainstream hard drive will fill up in 6 hours. The data playback process will also require such a long wait. If the data processing function is added during the playback process, the process will be longer. Work efficiency may be reduced as a result. Another bottleneck encountered in full waveform acquisition is the access speed of the hard disk. The access speed of mainstream serial hard disks is 40-50MB/s, which is equivalent to the speed of the USB2.0 interface. This limits the feasibility of using the updated technology USB3.0 interface. Although the speed of the USB3.0 interface has reached 5Gbit/s (640MB/s), if such a large amount of data cannot be stored in the hard disk in time after uploading, the disorderly loss of data is unavoidable. The full waveform AE instrument can use a general data acquisition card. It has a simple structure and low price, which is the choice for small data volume or tolerant data loss. In addition to the advantages of low price, the full waveform AE instrument also has the possibility of storing all the waveform data for in-depth and comprehensive waveform analysis. It also has the advantages that AE parameters can

be reproduced by changing the parameter generation conditions after the test, such as changing a lower threshold, changing the parameter definition time. With the improvement of computer communication capabilities, the application of full-wave AE instruments still has the possibility of increasing or even becoming mainstream instruments.

3.2.3 Technical indications of equipment

The technical index of the AE instrument is an index that quantifies and judges the ability of the AE instrument. The capability of an AE meter is defined by its ability to acquire and process, analyze, and view AE signals. A good AE instrument has a strong ability to obtain AE signals, with little or no loss, little distortion of the obtained signal, powerful signal analysis and processing display functions, and convenient operation. The ability to obtain AE signals can be expressed by technical indicators such as signal sampling accuracy, maximum sampling speed, data throughput rate, minimum signal level, maximum signal level, and signal frequency range which are shown in Table 3. The display ability of signal analysis processing can be expressed by the filter index, the number of parameter types, the number of parameter data analysis and waveform data analysis methods.

Table 3. Basic technical indicators of AE instruments

Technical index	Definition or content	Description
Maximum number of channels	The number of channels that can collect and process the transmission data synchronously	It determines the size of the structure that can be detected
Data passing rate of parameter(HN/s)	The number of AE impact parameter groups that can	It is the bottleneck of data processing speed. Data will

	be received continuously in real time per second	be lost if the parameter pass rate is insufficient
Data passing rate of wave(MB/s)	The number of AE waveform data that the system can receive continuously in real time per second	It is the bottleneck of data processing speed. Data will be lost if the parameter pass rate is insufficient
Maximum sampling rate(MHz)	AD conversion data points per unit time	The higher the maximum sampling rate, the finer the scale in the time direction and the smaller the distortion error of the waveform data collected, including amplitude distortion. Sampling rate has a greater impact on high-frequency signals
Sampling accuracy(bit)	The number of division intervals of the waveform data amplitude range	The higher the accuracy is, the finer the scale of the waveform signal in the amplitude direction and the smaller the signal distortion are. Accuracy has a greater impact on situations where the signal amplitude is large.
Noise level(uv)	In the absence of a valid signal, the collected invalid signal level	The noise level determines the minimum effective

		signal level that the system can collect
Signal dynamic range of acquisition system(dB)	Range of signals that can be collected	The range between the maximum undistorted amplitude of the signal and the minimum detectable signal, the minimum effective signal is usually equivalent to the noise level
Signal frequency range	The frequency range that signal is not distorted and the drop does not exceed 3dB	In general, the wider the frequency range, the wider the application range, which is suitable for the preliminary analysis of unknown signals.
Real-time filter performance (order)	The ratio of the in-band and out-of-band amplitudes, the number of frequency bands can be selected	The larger the ratio of the in-band to the out-of-band amplitude, the better the filtering effect. The more the number of selectable frequency bands, the more convenient it is to use

3.2.4 Auxiliary equipment

From the preamplifier to the multi-channel digital AE detector host, that is, the digital acquisition system, a long signal transmission line and the power supply cable for the preamplifier are often required. Usually, coaxial cables are used to complete the three

tasks of signal transmission, preamplifier power supply and probe calibration signal transmission. Coaxial cables are mainly used in the field of video communication, mainly in 50 ohms and 75 ohms. AE instruments mostly use coaxial cables with an impedance of 50 ohms. The length of the cable is generally selected within 100 meters.

The voltage level of the signal output by the sensor is on the order of microvolts. If such a weak signal is transmitted over a long distance, the signal-to-noise ratio will inevitably decrease. Set the preamplifier close to the sensor to raise the signal to a certain extent. Commonly used preamplifiers are 34, 40 to 60 decibels. The high-frequency coaxial cable is transmitted to the signal processing unit. The input of the preamplifier is the analog signal output by the sensor. The output is an amplified analog signal, and the preamplifier is an analog circuit.

The output impedance of the sensor is relatively high. The preamplifier needs to have impedance matching and conversion functions. Sometimes the output signal of the sensor is too large, requiring the preamplifier to have the ability to protect against electrical shocks and the ability to recover from blocking phenomena. It also has a relatively large output dynamic range.

One of the main technical indicators of the preamplifier is the noise level, which should generally be less than 10 microvolts. For some special purpose, the noise level of the preamplifiers should be less than 2 microvolts.

For single-ended sensors, a single-ended input preamplifier should be used. For differential sensors, a differential input preamplifier should be used. The latter has a certain degree of resistance to common mode interference than the former.

In the AE system, the preamplifier occupies an important position. The noise of the whole system is dominated by the performance of the preamplifier. The function of preamplifier in the overall system is to boost the signal-to-noise ratio while maintaining a high gain and low noise efficiency. In addition, it also has the advantages of convenient adjustment, good consistency, and small size. In addition, the pre-

amplifier should also have a certain degree of strong anti-interference ability and the ability to eliminate noise. Since AE detection is usually conducted in an atmosphere with high levels of mechanical noise (frequency band is usually lower than 50KHz), liquid noise (usually 100KHz ~ 1MHz) and electrical noise.

The preamplifier can also be integrated with the sensor to form an integrated sensor with a preamplifier. In terms of layman, the preamplifier is placed in the sensor housing. This requires the design of a small preamplifier circuit.

In the AE detection instrument, the filter is inserted into the appropriate position of the entire system in order to obtain high-quality data and avoid the influence of noise. The location of the filter is generally in the preamplifier, the conditioning circuit before the analog-to-digital conversion, the digital signal processing circuit after the analog-to-digital conversion, and the software filter of the PC computer. The working frequency of the filter is determined according to the environmental noise (mostly less than 50 kHz) and the frequency characteristics of the AE signal of the material itself. It is usually selected in the range of 60 to 500 kHz. If a band-pass filter is used, after determining the operating frequency f , the width of the frequency window needs to be determined, that is, the relative width $\Delta f/f$. If the relative width is too large, it is easy to introduce external noise and the filtering effect will be lost. If the relative width is too small, too few AE signals are detected, which reduces the detection sensitivity. Therefore, $\Delta f = +0.1f$ to $+0.2f$ is generally adopted. In addition, when determining the working frequency of the filter, it should be noted that the passband of the filter should match the resonant frequency of the sensor. The filter can be an active filter or a passive filter.

The preamplifier filter has a fixed frequency band and is placed in the preamplifier. The analog filter of the acquisition card is composed of multiple sets of high-pass and low-pass filters. Users can choose through software to achieve real-time continuous filtering of the waveform and use the filtered and reconstructed waveform to generate AE characteristic parameters (Morizet et al., 2016). The digital filter of the

acquisition card can set the frequency window arbitrarily, and choose the filtering methods of band pass, band stop, high pass, low pass. It can be used in conjunction with the existing analog filtering of the capture card. The filter stopband attenuation can accumulate and enhance the filter effect. It realizes real-time continuous digital filtering of the waveform and uses the filtered and reconstructed waveform to generate AE characteristic parameters. The upper computer software filter can be used flexibly in post-analysis, which can set the frequency window arbitrarily, and choose the filtering methods such as band pass, band stop, high pass, and low pass. The use result does not affect the generated parameters.

The sensor signal line is used to connect the sensor and the preamplifier. It generally uses a well-shielded coaxial cable. The signal is very susceptible to interference from external electromagnetic signals during the transmission process because the signal output of the sensor is very weak and the impedance is very high. Shortening the length of the sensor signal line as much as possible is the main method to reduce interference. Generally, the length of the signal line is about 1 meter.

Another important technical indicator of the sensor signal line is the capacitance, which will affect the output impedance of the sensor and affect the gain accuracy of the preamplifier.

3.2.5 Selection of AE testing instruments

The choice of the number of channels directly affects the distance of the sensor, which will affect the attenuation of the AE signal. In order to ensure the effective reception and positioning of the AE signal, the attenuation must be within a controllable range. Since the attenuation of the AE signal is also affected by the material, thickness, temperature, and signal frequency of the measured object, the best-effect solution can ensure that it can be detected normally even when there is a bad situation that causes the attenuation to increase. If the signal attenuation of the measured object is

small, the number of channels recommended by the most economical solution may be used normally.

Improving the sampling accuracy can improve the resolution of tiny signals and reduce the system error when collecting small amplitude signals.

The 16-bit precision signal resolution is 1.53uV, and the 18-bit precision signal resolution is 0.38uV. When the effective signal amplitude is different, the system error that affects the measurement is different. For details, please refer to the Table 4:

Table 4. Measuring system error of two sampling rates with different effective signal amplitudes

Effective signal amplitude/dB	18-bit system error /dB	16-bit system error /dB
10	0.98993	3.42208
20	0.32518	1.23348
30	0.10423	0.40961
40	0.03307	0.13154
50	0.01048	0.04184
60	0.00331	0.01324
70	0.00105	0.00419
80	0.00033	0.00133
90	0.0001	0.00042
100	0.00003	0.00013

For general engineering detection, the signal threshold setting is generally around 40dB, which corresponds to a small signal that has just passed the threshold. It was

shown in the table 2.3 that the 16-bit system error is 0.13dB, and for the effective signal of 60-70dB, the 16-bit system error is 0.01dB, which can fully conform to usage criteria.

When the effective signal of 18-bit system is about 30dB, the error is at the level of 0.1dB. For the effective signal of 40dB, the 18-bit system error has been reduced to the level of 0.03dB. Therefore, it is weak and effective for some special needs to collect about 30dB. In the field of signal research, the 18-bit system is a suitable choice.

3.3 Noise sources in AE measurements

Various detection methods face the problem of interference noise. The noise interference problem is particularly serious because AE is used for dynamic monitoring in a passive way. In many cases, the external interference noise may be far greater than the AE signal people need, such as the use of AE for machine error monitoring, operating equipment condition monitoring, and dynamic monitoring of the drive shaft and steering knuckle of a moving car. There are many types of interference noise faced by AE monitoring.

Electrical interference noise mainly consists of:

- (1) White noise at the input of the preamplifier: This is a natural and unavoidable noise that determines the ultimate limit of system sensitivity. With a well-designed preamplifier, the noise can be small and close to the theoretical limit.
- (2) Noise generated inside the AE system: The compact computerized AE instruments currently used generally have a Cathode Ray Tube (CRT) display screen and a disk system. The various components are prone to "pick up" noise. In a well-designed system, this noise should be low and within limits.
- (3) Ground loop noise: This is caused by improper grounding of the system or structure. To avoid this noise. The electrical connection of the AE transducer must be insulated from the structure.

- (4) Electromagnetic interference signal: It is generally caused by a power switch or other nearby electromagnetic equipment. When necessary, electromagnetic shielding should be added to the equipment.

Mechanical noise source mainly includes:

- (1) the noise of the testing machine in the laboratory.
- (2) The operating noise of the equipment during the field test, including the noise from the inside of the container and the noise from the connecting pipe.
- (3) The fluid noise of pumps and valves.
- (4) All friction processes, such as movement caused by loading and the support of the container.
- (5) Noise caused by mechanical impact, such as noise caused by dust, raindrops, and snowflakes during outdoor testing.
- (6) Noise caused by human beings and surrounding animals.

Usually at the AE source, most AE signals have relatively simple broadband and step-shaped characteristics. However, the waveform will be greatly distorted after multiple reflections, attenuations, and waveform conversions in the material or structure. This brings great difficulties to the analysis of AE signals. Most of the objects monitored by AE technology are solids, in which there are different wave types, such as compression waves, shear waves, slab waves, and surface waves. The propagation speed of these waves is different, and the wave form conversion occurs at the boundary. In addition to the direct wave, the sound wave emitted by the source can also reach the sensor via a variety of paths. Therefore, the detected sound signal waveform is the superposition of the sound waves from different paths to the sensor (reverberation effect). This superposition of different waveforms complicates situation. In addition, the sensor itself has the so-called "ringing" effect (sensor response), which leads to more complex output signals. In many cases, how to obtain useful information from such a relatively complex signal has become the key question (Geng et al., 2002).

3.4 Noise reduction methods of AE

(1) Choosing an appropriate working frequency (Hu et al., 2008): In the early research on AE, researchers have tried to use the audible sound frequency band ($<2.20\text{kHz}$) and use the microphone as a sensor. In this way, it is necessary to observe the AE signal in the dead of night to avoid noise interference from traffic and crowds outside as much as possible. It was not until the 1960s that some AE researchers, especially American scholar Dunegan (1969) found and realized that AE signals can extend to higher frequency domains which is several megahertz or even tens of megahertz. The impact of high-frequency environmental noise is relatively small. The frequency range of most mechanical noise can only reach several tens of kilohertz. Therefore, choosing a sensor with a resonance frequency of 50 to 300 kHz or higher can effectively overcome the effect of interference noise. For the AE signal generated by the crack propagation of an airplane wing, it may be more advantageous to choose a higher frequency (500-600kHz).

Some interference comes from some nearby fixed radio equipment. For example, when using AE to conduct pipeline leakage test, it was found that there was a modulated interference signal with a carrier frequency of 100kHz, which was caused by a nearby transmitter and can be suppressed after filtering.

(2) Application of differential sensors: The differential sensor is composed of two wafers of opposite polarity. The output is sent to the two input terminals of the differential amplifier. The AE signal produces signals of opposite polarity, and their difference is amplified. The polarity of the electromagnetic interference signal is the same, and the common mode rejection of the preamplifier is greatly weakened.

(3) Application of voltage threshold or reduction of test sensitivity: This method can simultaneously remove AE signals and noise signals below the threshold. Due to the large influence of AE events to material damage, this method has been widely used.

(4) Application of different gates: One of the most typical feeds using time gate is the welding quality test and control circuit. To suppress the noise from the power switch, the test circuit is turned off during most of the time when the noise is active. It only works when the welding zone is solidified, that is, when a useful AE signal is generated.

Load control gate is particularly useful in fatigue tests. In the cyclic fatigue test, "backlash" will cause serious interference noise when the load changes from tensile stress to compressive stress and passes through the zero-load point. In addition, the friction of the crack surface will cause strong interference noise even in the middle load section. Although the latter may catch research interests in some cases, it will have a great negative impact when only the crack propagation is studied. For this reason, studies often use electronic gate circuits to record AE data only when the load is close to the maximum value. This method has become a key to the success of fatigue test monitoring.

Some special noises, such as rain, can be specifically detected with an additional sensor, which can shut down the main test circuit when these noises appear. AE monitoring of large oil storage tanks is commonly used in noise-based gate road.

(5) Guarding sensors and spatial filtering: This is particularly useful for monitoring a specific area of a component such as an aircraft wing section. By installing several guard sensors outside the area where the test sensors are connected, any signal received by the guard sensor first is regarded as noise and rejected. Spatial filtering is since the time difference between the crack signals generated in the monitored area to reach two or more sensors should be within a certain range (window). Only the data that meets this condition will be recorded and it will be rejected, otherwise.

4 ANALYSIS OF ACOUSTIC EMISSION SIGNALS

4.1 Parameter analysis of AE signal

The AE signal has a wide dynamic range. The generation rate of AE signals is also volatile. Due to the above-mentioned characteristics of AE signals, the existing methods for collecting and processing AE signals can be classified into two groups. One is to express the characteristics of the AE signal with multiple simplified waveform characteristic parameters and then analyze and process them. The other is to store and record the waveform of the AE signal and perform spectrum analysis on the waveform. The simplified waveform characteristic parameter analysis is a classic method that has been widely used to analyze AE signal since 1950s and still widely used in AE detection. Almost all AE detection standards adopt simplified waveforms characteristic parameter for criteria of AE sources.

The simplified waveform parameters for burst-type standard AE signals are described in Figure 3. From this model, parameters such as wave hit (event) count, ring count, energy, amplitude, duration and rise time can be obtained. For continuous AE signals, only ring count and energy parameters in the above model are applicable (Yang&Geng, 2005). The average signal level and the effective value voltage are added to define the characteristics of the continuous AE signal more precisely.

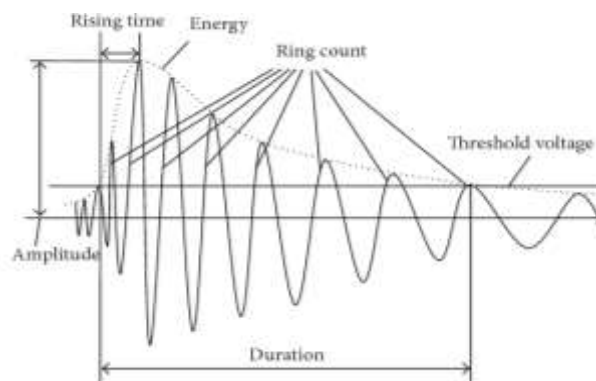

Figure 3. Signal characteristic parameters

The meanings and uses of the characteristic parameters of commonly used AE signals were listed in Table 5. The accumulation of these parameters can be defined as a function of time or test parameters (such as pressure and temperature), such as total event count, total ringing count, and total energy count. These parameters can also be defined as functions that change with time or test parameters, such as the count rate of AE events, the count rate of AE ringing, and rate of AE signal energy (Li, 2010). Any two combinations of these parameters can also be used for correlation analysis, such as the amplitude distribution of AE events, the energy-duration correlation diagram of AE events.

Table 5. Features and application of Some AE parameters (Shen et al., 2002)

Parameter	Meaning	Features and uses
Event count	A local change of material that produces AE is an AE event, which is divided into total count and count rate	Reflects the total amount and frequency of AE time; used to evaluate source activity and localization concentration
Ring count	The number of oscillations of the signal crossing the threshold, divided into total count and count rate	Simple signal processing, suitable for two types of signals; roughly reflect the signal strength and frequency; widely used in the evaluation of AE activity; affected by the threshold value
Amplitude	The maximum amplitude value of the signal waveform, which is usually expressed in dB	directly related to the size of the event; not affected by the threshold; directly determines the measurability of the event; used to identify the type of wave source and measure the intensity and attenuation.
Energy count	The area under the signal detection envelope, divided	Reflects the relative energy or intensity of the event;

	into total count and count rate	not very sensitive to the threshold, working frequency and propagation characteristics; can replace the ringing count; used for wave source identification
Effective value voltage	The root mean square value of the signal within the sampling time, expressed in V	Related to the size of AE; easy to measure; not affected by the threshold; suitable for continuous signals; mainly used for continuous AE activity evaluation

Due to the limited number of parameters that early AE instruments could obtain, such as count, energy, or amplitude, early study and evaluation of AE signals tended to use single-parameter analysis methods. The most used single parameter analysis methods are counting analysis, energy analysis and amplitude analysis.

4.1.1 Counting method

Counting method is a common method for processing AE pulse signals. The currently used counting method includes the count rate of AE events, the count rate of ringing and their total counts. There is also a counting method that weights the amplitude, which is called the weighted ring counting method. AE events are single burst-type signals created as a result of localized material changes. The count of AE is the number of times an AE signal exceeds a predefined threshold. The count rate is the number of times the signal unit time reaches the threshold. The AE count rate depends on the response frequency of the transducer, the damping characteristics of the transducer, the damping characteristics of the structure and the level of the threshold. For an AE event, the AE count detected by the transducer is:

$$N = \frac{f_0}{\beta} \ln \frac{V_p}{V_t} \quad (1)$$

In the Equation 1, f_0 is response center frequency of transducer. β is wave attenuation coefficient. V_p is Peak voltage and V_t is Threshold voltage.

The disadvantage of the counting method is that it is easily affected by factors such as sample geometry, transducer characteristics, connection methods, threshold voltage, amplifier and filter working conditions.

4.1.2 Energy and amplitude analysis method

Due to the above-mentioned shortcomings of the counting method for measuring AE signals, especially continuous AE signals, the energy of the AE signals is usually measured to analyze the continuous AE signals. At present, the energy measurement of AE signals is one of the main methods of quantitatively measuring AE signals. AE signal energy is proportional to the region of the AE waveform shown in Figure 3. The root means square voltage V_{rms} or the mean square voltage V_{ms} is often used to determine the energy contained in an AE signal. AE instruments mostly use digital circuits. It can also directly measure the area of the AE signal waveform. For burst AE signals, the energy of each event can be measured.

Definition of the mean square voltage and root mean square voltage of a signal $V(t)$ is.

$$V_{ms} = \frac{1}{\Delta T} \int_0^{\Delta T} V^2(t) dt \quad (2)$$

$$V_{rms} = \sqrt{V_{ms}} \quad (3)$$

In the Equation 2 and 3, ΔT is the average time and $V(t)$ is time-varying signal voltage.

According to the theory of electronics, the variation in V_{ms} with time is proportional to the rate of energy change of the AE signal. The Equation 4 can be used to express the total energy E of the AE signal from time t_1 to t_2 .

$$E \propto \int_{t_1}^{t_2} (V_{rms})^2 dt = \int_{t_1}^{t_2} V_{ms} dt \quad (4)$$

The measurement of AE signal energy can be directly connected with important physical parameters of the material (such as the mechanical energy of the AE event, strain rate or deformation mechanism) without the need to establish an AE signal model. Energy measurement solves the measurement problem of small amplitude continuous AE signals. In addition, there are many advantages for measuring the root mean square voltage or mean square voltage of the signal. First, V_{rms} and V_{ms} are not very sensitive to small changes in electronic system gain and transducer coupling. It does not depend on any threshold voltage. It is not closely related to the size of the threshold like the counting technology; Secondly, V_{rms} and V_{ms} are directly related to the energy of the continuous AE signal, while the counting technology does not have such a simple relationship; Moreover, V_{rms} and V_{ms} are easy to modify different strain rates or different sample volumes.

The signal peak amplitude and amplitude distribution is a processing technique that more accurately reflects the information contained in the AE source. The amplitude of the signal is proportional to the strength of the AE source in the material. The amplitude distribution is related to the deformation mechanism of the material (Pollock, 1986). The measurement of the amplitude of the AE signal is also affected by factors such as response frequency of the transducer, the damping characteristics of the transducer, the damping characteristics of the structure and the threshold level. Through the application of logarithmic amplifier, both large and small AE signals can be applied for accurate peak amplitude measurement.

The empirical formula for the amplitude, event and count of the AE signal is:

$$N = \frac{Pf\tau}{b} \quad (5)$$

In the Equation 5, N is AE signal accumulates ring count. P is AE signal event total count. f is Response frequency of transducer. τ is Fall time of AE event. b is the slope parameter of the amplitude distribution.

4.1.3 Experience map analysis method

The AE signal experience analysis analyzes the changes of AE signal parameters with time or external variables to obtain the activity and development trend of the AE source. The most common used and most intuitive method is graphical analysis. The experience map analysis can be used for the activity evaluation of the AE source, the Felicity ratio and Kaiser effect evaluation, the constant load AE evaluation and the measurement of the initiation point.

4.1.4 Distribution analysis method

The aim of the AE signal distribution analysis method is to examine the statistical distribution of the AE signal impact count or event count based on the signal parameter value. When analyzing a distribution diagram, the vertical axis chooses effect count or event count. The horizontal axis is used to select some AE signal parameter. Bell count distribution, duration distribution and rise time distribution, among which amplitude distribution is the most widely used. Distribution analysis can be used to discover the features of AE sources in order to distinguish the different types of AE sources, such as crack propagation and plastic deformation in metal materials and fiber fracturing and substrate cracking in composite materials. This method is also commonly used to evaluate AE and source strength (Yuan, 2011).

4.1.5 Association analysis method

The correlation analysis is also the most common used method in the evaluation of AE signals. The waveform characteristic parameters of any two AE signals can be analyzed as the correlation diagram. By making correlation diagrams between different parameters, the characteristics of different AE sources can be analyzed. It plays a role

in identifying AE sources. For example, Certain types of electronic interference signals usually have a large amplitude but a very low intensity. The amplitude-energy correlation diagram identifies it. For pressure vessels, the internal medium leakage signal has a much longer duration than the signal generated by the vessel shell. Through the analysis of the energy-duration or amplitude-duration correlation diagram, it is easy to find the leakage of the pressure vessel. The American MONPAC AE inspection club evaluates the quality of the AE inspection data of metal pressure vessels in the form of the correlation diagram of the AE signal count and amplitude (Stockbridge& Hoffman, 1994).

4.2 Spectrum analysis of AE signal

The spectral analysis technique can be used to determine the spectral characteristics of signal. It is classified into classic and modern spectrum analysis.

4.2.1 Classification of spectrum analysis

The classical spectral analysis method is based on the Fourier transform, which mainly includes correlation graph method and period graph method as well as improved methods on this basis (Shevchik et al., 2018). The most basic and most important method is the Fast Fourier Transform (FFT). Since the Fourier transform can be realized by FFT, this method has a simple principle and fast running speed. The classical spectrum analysis method has been applied in the fields of material deformation, mechanical cutting damage. However, the resolution of this method is not in high quality and the error is large. The non-periodic nature of the AE signal makes classical spectrum analysis less effective. Therefore, the classical spectrum analysis method has not been widely used (Chen et al., 2002).

Modern spectral analysis methods are focused on non-Fourier analysis, which can be broadly classified into two categories: parametric model method and non-parametric model method. The parameter model technique includes rational parameter model

and special parameter model. The rational parameter models can be represented by rational system functions, including autoregressive (AR) models, moving average (MA) models, and autoregressive moving average (ARMA) models. The special parameter model is the exponential model, which defines the signal as a linear combination of some exponential signals. Non-parametric model methods include other modern spectral analysis methods that do not need to establish a parametric model and focus on feature separation based on autocorrelation matrix or data matrix. It primarily consists of minimum variance method, iterative filtering method and Pisarenko method (Liu&Chen, 2001). Modern spectrum analysis overcomes the shortcomings of classical spectrum analysis and uses a suitable parameter model to fit the signal or uses a feature separation method to estimate the signal, which improves the resolution and approximation of the spectrum. The spectrum analysis method can distinguish signals with similar waveforms, which provides a correct guidance for the detection method. The premise is that the signal being analyzed is cyclically stable. However, the AE signal is a spontaneous signal that is not stationary. In addition, spectrum analysis is a global analysis method and cannot reflect the local information of the signal. Therefore, the effect of spectrum analysis is limited. Its resolution is not high, and the estimation error is large (Yan&Liu, 2002).

Correlation analysis of two signals can understand the degree of similarity between them. In AE, the correlation methods are indispensable to realize the detection, identification, and extraction of one or more signals after delay, just like in the frequency domain. The spectrum analysis is the same. Correlation analysis in the temporal domain is widely used in the field of signal processing. The fast correlation is based on the related technology, combined with the technology implemented by FFT, which can speed up the calculation. Among the above methods, the frequency domain spectrum analysis technology is commonly applied in the study of AE signals due to its relative simplicity and practicality and used as a supplementary analysis tool. For example, spectral analysis method can be used for preprocessing before wavelet analysis (Geng, 2001). The more common application is the spectrum analysis method

based on FFT. The FFT algorithm quickly transforms the digital signal in the time domain into its corresponding spectrum. It can obtain various characteristics of the signal from the spectrum, and the estimation of the classical spectrum is fast and simple. The time-domain related technology is widely used as a means of analyzing signals with the same simplicity and practicality (Shen et al., 2001).

4.2.2 Principle of FFT-based analysis method

The discrete Fourier transform (DFT) is characterized by:

$$X(k) = \sum_{n=0}^{N-1} x(n) e^{-\frac{j2\pi kn}{N}} \quad k = 0, 1, \dots, N-1 \quad (6)$$

$$x(n) = \frac{1}{N} \sum_{k=0}^{N-1} X(k) e^{\frac{j2\pi kn}{N}} \quad n = 0, 1, \dots, N-1 \quad (7)$$

In the Equation 6 and 7, $X(k)$ is the k th value of the discrete spectrum. $x(n)$ is N th value of time domain sampling.

Direct DFT operation requires N^2 operations on N sampling points. The FFT algorithm reduces the N^2 step operation to $(\frac{N}{2}) \log_2 N$ steps greatly increase the speed of calculation and bring revolutionary progress to digital signal processing without any loss in accuracy. Discrete Fourier transform is the transformation of sampled data in a finite time interval (called time window). This finite time window is the premise of DFT. It will cause some undesirable results in the transformation, namely Spectral leakage and fence effect (Hu, 2005).

The most ideal way to eliminate spectral leakage is to select the length of the time window so that it is exactly an integer multiple of the periodic signal and then make DFT. The current technology, however, cannot achieve this operation. The actual method is to weight the time window with a function, so that the sampled data is processed by the window function and then transformed. The weighting function is called a window function or window. Under the concept of weighting, the time window can be regarded as a window function with equal weight, that is, the function

of the time window itself is equivalent to the weight of a rectangular window function with the same width. The simple principle for selecting the window function is to make the signal zero at the edge of the window, which reduces the effect of discontinuity caused by truncation. After the signal is weighted by the window function, information will not be lost too much. Based on the above analysis, the window function is used as a preprocessing method to realize the spectral continuity of the signal in the AE signal processing, usually when performing FFT (Liu, 1996).

4.3 Wavelet analysis of AE signal

Wavelet analysis is a technique for signal processing that was developed in the last two decades. It can describe the local frequency spectrum signal in a certain period and can also describe the time domain information corresponding to a certain frequency spectrum information. As a new theory, wavelet analysis is an important achievement in the history of mathematics. The basic idea is to use a cluster of functions to describe or approximate a signal or function. The wavelet function system which consists of a basic wavelet function translation and expansion is the collective term for this set of functions. Wavelet transform is different from Fourier transform. It is a local transform of time and frequency, so it can extract effective information from the signal. It is mainly used for signal noise separation in the AE signal to realize the denoising function (Wang et al., 2015). For noise-containing AE signals, wavelet transform can effectively remove noise from signals, obtain signals related to the AE source, and minimize the reliance of data collection on the environment (Xu&Sun, 2001).

A wavelet is a discrete waveform with a finite duration and a zero-average value. (Qi, 2000). In the Equation 8, it is supposed $\phi(t)$ is a square integrable function, Fourier transform is $\psi(\omega)$, when $\psi(\omega)$ satisfies the condition (Gallego et al., 2005)

$$C_{\psi} = \int_{-\infty}^{+\infty} \frac{|\psi(\omega)|^2}{|\omega|} d\omega < \infty \quad (8)$$

Then $\varphi(t)$ is called a basis wavelet function.

The basis wavelet function $\varphi(t)$ is stretched and translated to obtain the function $\varphi_{a,b}(t)$

$$\varphi_{a,b}(t) = \frac{1}{\sqrt{|a|}} \varphi\left(\frac{t-b}{a}\right) \quad (9)$$

In the Equation 9, a is the scale factor and b is the translation factor.

The meaning of wavelet transform is to take the base wavelet function $\varphi(t)$ as the displacement b and form the inner product with the signal $f(t)$ to be analyzed at various scales a :

$$W_f(a, b) = \frac{1}{\sqrt{|a|}} \int_{-\infty}^{+\infty} f(t) \overline{\varphi\left(\frac{t-b}{a}\right)} dt \quad (10)$$

In the Equation 10, it is called the wavelet transform coefficient. If the scale factor a and time factor t of the formula are discretized, the formula becomes a discrete transformation of $f(t)$. Through the discrete wavelet transform, an objective function can be decomposed into a high-pass filter D_i and a low-pass filter A_i . The function in each low-pass filter A_i can be decomposed into another high-pass filter D_{i+1} and low-pass filter A_{i+1} . This process can be repeated many times until the desired decomposition effect is obtained (Zhao et al., 2018). The Figure 4 shows the model tree of wavelet discrete transform.

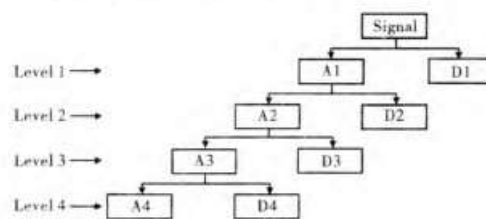

Figure 4. Wavelet transform tree (Khamedi et al., 2010)

The mathematical model formula of the wavelet discrete transform in the Equation 11:

$$f(t) = \sum_{i=1}^{i=j} D_i(t) + A_j(t) \quad (11)$$

By decomposing the original AE signal in the above manner, noise interference of the AE signal can be effectively eliminated. By selecting appropriate signal channel to reconstruct the decomposed signal, an effective AE waveform can be obtained. Figure 5. (a) is a record of the original waveform of AE. It is difficult to judge important information such as the time, energy and amplitude of the AE event. Figure 5(b) is the denoising result of applying wavelet analysis to the waveform of the AE event shown in Figure 5(a). The de-noising results show that the processing of AE signals by wavelet analysis is feasible. The purpose of signal-to-noise separation is to separate the noise in the signal from the useful signal, which is an important aspect of wavelet analysis applied to signal processing.

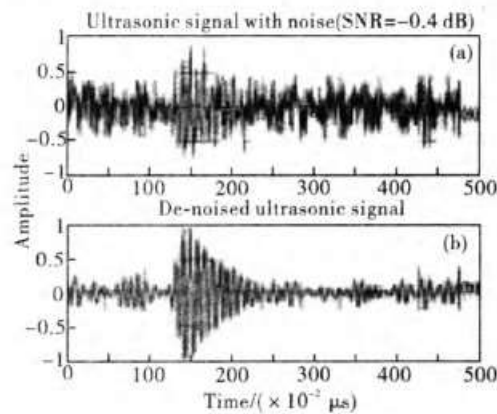

Figure 5. Typical AE signals (Song, 2006)

The characteristics and functions of Wavelet transform are listed below:

- 1) The wavelet transform has the characteristics of multi-scale, and the signal can be observed gradually from coarse to fine.

2) It uses a band-pass filter with basic frequency characteristics to filter signals at different scales.

3) The wavelet function has diversity, which means that different wavelet bases will get different results when analyzing the same signal. Proper selection of the basic wavelet is convenient for detecting the transient or singularity of the signal.

Wavelet analysis can clearly distinguish AE signals mixed with noise. However, due to the wide variety of wavelet bases, analyzing the same AE signal using different wavelet bases can provide different results and wavelet analysis needs to process a large amount of raw data. Therefore, wavelet analysis has certain limitations (Xu et al., 2014).

4.4 Neural network analysis of AE signal

Neural network analysis is an emerging technology method that has grown in popularity in recent years as a result in the advancement of computer technology. Artificial Neural Network (ANN) is an artificial network formed by extensive interconnection of many processing units, which is used to simulate the structure and function of the brain nervous system (Kwak& Ha, 2004). In engineering and academia, it is often abbreviated as neural network or quasi-neural network. Information processing units (neurons) are also called nodes (Saeedifar&Zarouchas, 2020). Each node sends out suppression or excitation signals to other neighboring nodes. The information processing of the entire network is completed through the interaction between these nodes. It mainly includes Back Propagation (BP) network, Radial Basis Function (RBF) network and Hamming network. Neural networks are currently mainly used to recognize patterns in AE signals.

The mathematical model of the neuron is shown in Figure 6.

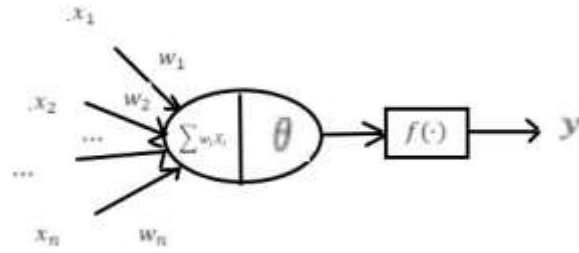

Figure 6. Neuronic node diagram

$[x_1, x_2, x_3, \dots, x_i]$ is the input vector. y is the output. $f(\cdot)$ is the excitation function. w_i is the corresponding weight coefficient. θ is the threshold. The input and output relationship are shown in Equation 12.

$$y = f(\sum_{i=1}^n w_i X_i - \theta) \quad (12)$$

The working process of artificial neural network can be classified into two stages: training and testing. In the training phase, a set of input and a set of output mode pairs are used as training sample sets to train the network. The process of network training is the adjustment process of network parameters (including weights and thresholds). In the test run phase, the new input is given, and the network can calculate the corresponding output.

4.4.1 BP neural network

The standard BP network is composed of three neuron levels, and the structure diagram is shown in the Figure 7. with the input layer on the left, the hidden layer in the center, and the output layer on the right. The forward propagation and back propagation phases of a BP network learning process are distinct. Forward propagation is the mechanism by which the input layer and hidden layer process the data and send it to the output layer. The state of neurons in each layer only affects the state of neurons in the next layer. If the desired output is not available in the output layer, back propagation is used. The error signal is reconnected along the original path, and the weights of each layer of neurons are changed to reduce the

error signal. When training the network, we must first provide a set of known training samples. When all the actual output of the network is consistent with the expected output of the sample, it indicates the end of training. Otherwise, the error signal of each layer of neuron is calculated and the weight of each layer is modified accordingly (Elforjani& Shanbr, 2017).

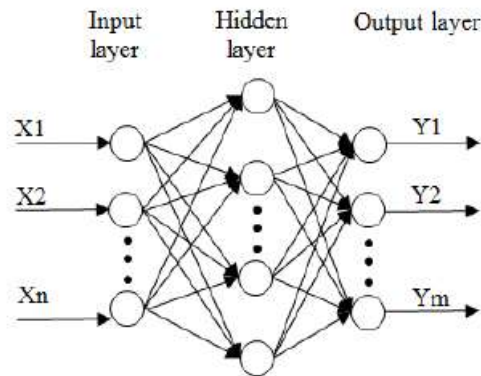

Figure 7. Back propagation (BP) network structure

4.4.2 Hamming neural network

Hamming network is also an artificial neural network model widely applied in pattern recognition. The main principle is to find the Hamming distance between the standard pattern and the input sample and complete competitive learning through mutual inhibition. The structure is shown in the Figure 8.. Two layers comprise the Hamming neural network. The input layer is used to calculate the Hamming distance between the standard mode and the input mode, while the competition layer completes the input mode classification. In the competition layer, the input is weighted through the interaction between nodes. Each node tries to maintain its own value while suppressing the output of other nodes. In this way, the Hamming network can always select the node with the best matching degree which is the point corresponding to the minimum Hamming distance (Meng et al., 2011).

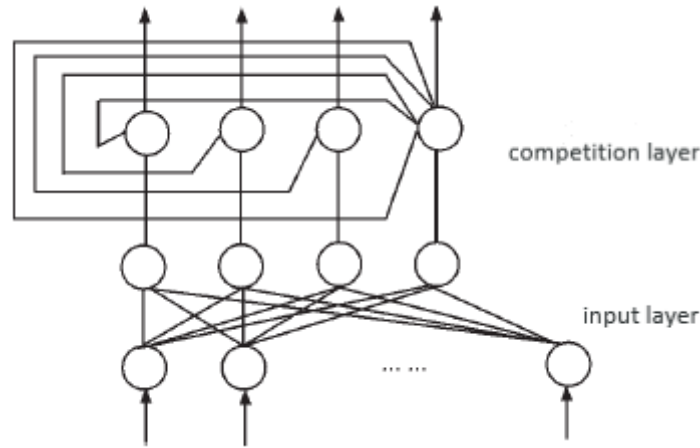

Figure 8. Hamming network structure

4.4.3 RBF neural network

The RBF neural network consists of three layers. Its structure is shown in the Figure 9 (Zhang et al., 2000). The input layer transfers input data (x_1, x_2, \dots, x_m) to the hidden layer. The hidden layer applies a fixed non-linear transformation to the input space in order to convert it to a new space. Generally, the hidden layer of RBF neural network uses Gaussian function to realize nonlinear transformation:

$$U_j = \exp\left(\frac{(x-c_j)^T(x-c_j)}{2\sigma_j^2}\right), j = 1, 2, \dots, N \quad (13)$$

In the Equation 13, U_j is the output of the j -th node in the hidden layer, and $U_j \in [0,1]$; N is the number of hidden layer nodes. c_j is the central value of the Gaussian function, $X = (x_1, x_2, \dots, x_n)^T$ is the input sample data and σ_j is the normalization constant. The learning and training of the RBF neural network includes determining the central value of the Gaussian function and its standardization constant, the connection weight of the hidden layer and the output layer linear transformation.

Two distinct stages can be identified in this process. In the first stage, the K-nearest neighbor clustering algorithm is used to determine the central value c_j and σ_j

normalization constant of the Gaussian function of the hidden layer node according to all the input sample data. The second stage calculates the weights of the connections between the hidden and output layers using a collection of input sample data $(X_j, j = 1, 2, \dots, M)$ and its hidden layer output values for training to minimize the error function which is:

$$e = \min \sum_{i=1}^M \|y_i - d_i\|^2 \quad (14)$$

In the Equation 14, d_i is the target output value of the training process.

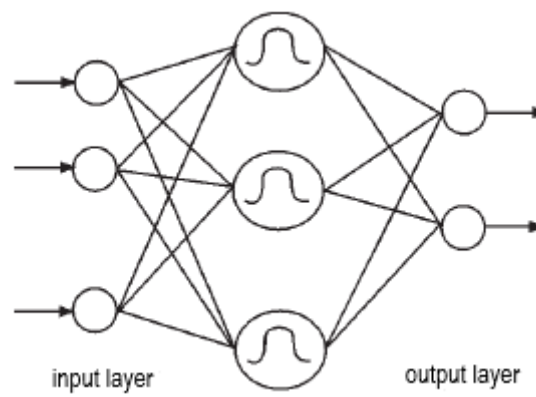

Figure 9. Radical Basis Function (RBF) network structure

At different stages of fault expansion, the parameters of the AE signal are significantly various. Based on this, standard pattern of the AE signal in different stages of fault expansion is determined, and the pattern recognition of the AE signal is completed by using the artificial neural network.

1) BP network is most used in pattern recognition of AE signals, and the theory is becoming more mature. But it is still needed to be tested in practice. When performing pattern recognition applications on live AE sources and revealing the generation mechanism of AE sources, it is temporarily unable to achieve satisfactory results. The BP network itself also has its limitations, that is, the convergence speed is slow, and it is easy to fall into a local minimum. In actual applications, the network scale can be appropriately decreased, and the network parameters can be modified to increase the convergence speed of the network (Xie, 2009).

2) Compared with BP network, hamming network is used for pattern recognition. Although the network converges fast, the application is limited as the standard pattern is difficult to determine (Li, 2010).

3) The biggest difference between RBF network and BP network is the difference in neuron transfer function. RBF neural network has better classification ability, faster learning speed and higher approximation accuracy than BP network. Research applications in this area have been paid more attention in AE research.

Although neural networks have high parallelism, self-organization, self-adaptation, and self-learning functions, which have been improved in AE pattern recognition, neural network training requires a lot of data. It is often difficult to provide a large amount of known training data and it may affect the learned samples when new samples appear. This results in the truth that neural network can only be in the experimental stage at present (Yi et al., 2002).

5 EXAMPLE OF FAULT DETECTION OF ROTARY MACHINE

The low-speed rotating machine is the most critical part of the wind turbine drive system. It is often threatened by technological and environmental deficiencies. These factors help to increase the economic requirements for the "health monitoring" and "condition monitoring" of the system. As this type of device fails, the energy loss rate of the associated process will be reduced. Therefore, if it cannot be used, the condition monitoring technology will be difficult to detect energy loss. However, this issue has been partly resolved in the case of AE technology, which is well suited for detecting extremely low energy release rates. AE technology enables the detection of sound associated with material failure. Acoustic waves are non-stationary signals that can be used to detect elastic stress waves in defective components. They can be tracked online and are extremely sensitive for fault diagnosis. Wind turbine productivity can be increased by incorporating various maintenance procedures, which can also help minimize maintenance costs if they are continuous and automated. As a result, research on fault detection and condition monitoring is of great significance. Numerous approaches, including vibration analysis, oil analysis, noise analysis, data analysis, and AE analysis, have been used to detect wind turbine faults.

5.1 Wind turbine major components and prevalent failures

Wind turbines are mostly located in rural areas. Unlike traditional power plants, they do not protect the power plants well in the face of high changes and severe weather, strong winds, tropical climates, lightning strikes, and icing. These justifications highlight the critical nature of fault detection technology in wind turbine maintenance. Obviously, in such a system, most of the electrical and mechanical failures with a high degree of correlation between its components can lead to different failures and fatigue. Figure 10. shows the main components of a typical wind turbine facing all of the above problems. Further research shows that the most common faults are the

root cause of the gearbox, yaw system, generator and rotor brakes and other subsystems.

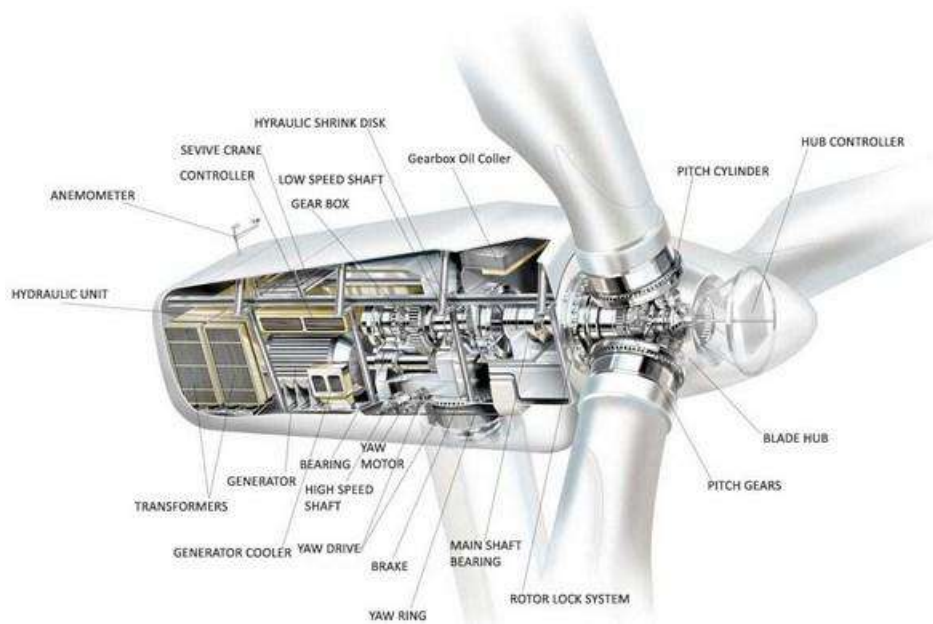

Figure 10. The major component of a wind turbine (Purarjomandlangrudi&Nourbakhsh, 2013)

The wind turbine will continue to function until it is rendered inoperable by the failure, at which point it will be maintained or replaced (reactive maintenance) based on the nature or severity of the damage. Preventive maintenance (PM) has gained increased attention as a result of the development and expansion of wind turbines. This approach necessitates routine inspections based on scientific methods for assessing condition. These approaches are often prohibitively costly and insufficiently systematic. With the advent of technology and the introduction of condition monitoring and fault detection technologies, empirical condition evaluation has evolved into predictive maintenance (PdM) and condition-based maintenance (CBM), but these empirical approaches are typically prohibitively costly and insufficiently systematic. With the advancement of technology and the introduction of condition monitoring and fault detection technologies, wind farm owners and academia have put a premium on PdM and CBM.

5.2 Experiment results

5.2.1 Low speed test rig

In rolling element components such as bearings and gearboxes, defects usually occur over a long period of time. Therefore, to gain a better understanding of the signal characteristics associated with each failure, it is important to simulate their typical failures in a controlled environment. To accomplish this, a laboratory-developed low-speed machine test bench was built by team of Purarjomandlangrudi, as illustrated in Figure 11. The main components of the test bench include electric motors, flexible couplings, three sets of interchangeable rolling bearings, reduction gearboxes, and variable speed drives and safety control devices. The AE sensor used in the experiment is a resonance type "R6a" sensor from Physical Acoustics Corporation (PAC).

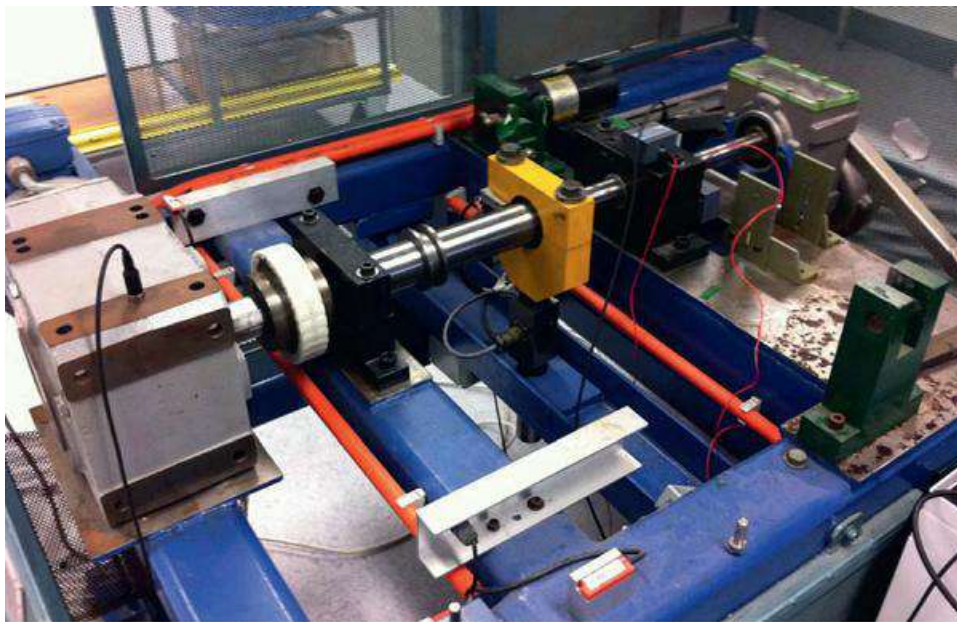

Figure 11. Test rig (Purarjomandlangrudi&Nourbakhsh,2013)

The sensor operates at a frequency range of 35 kHz to 100 kHz. Prior to being captured by the National PXI data acquisition system, the signal of sensor is amplified by a corresponding PAC preamplifier which is shown in Figure 12. A single row cylindrical roller bearing (NSK-NF307 type) with a removable outer ring was used in the simulated

failure experiment. The bearing consists of 12 rolling components with a 35 mm inner diameter and an 80 mm outer diameter. To simulate the outer ring of the bearing failing initially, a very fine scratch was indented as shown in Figure 13. In the next section, the AE signal captured from the measurement is used for analysis.

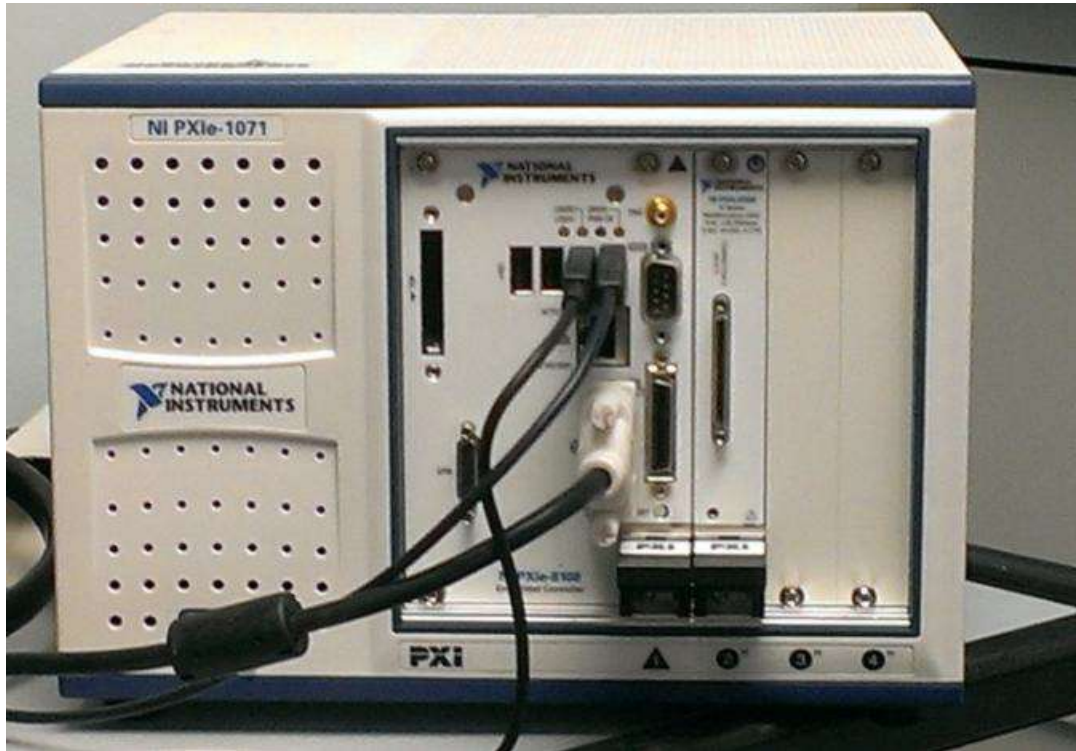

Figure 12. PXI data acquisition system (Purarjomandlangrudi&Nourbakhsh, 2013)

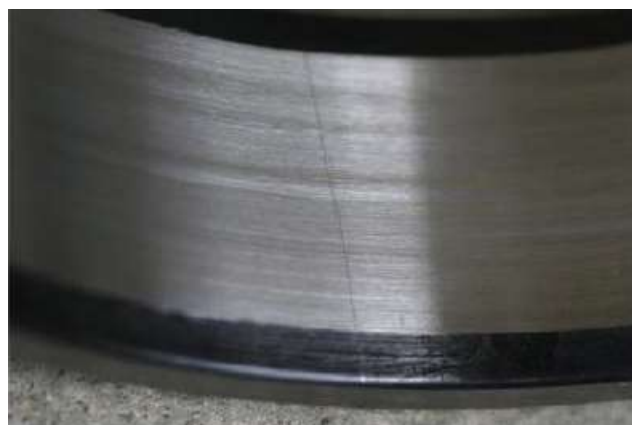

Figure 13. Graphical illustration of the simulated incipient bearing outer race defect (Purarjomandlangrudi&Nourbakhsh, 2013)

5.2.2 Time domain statistical parameters

By analyzing the acoustic data obtained from the data acquisition system, various methods can be applied to fault detection and fault diagnosis. The time-domain statistical method is a traditional method, which is widely used in signal processing and plotting different characteristics of the signal (Dhole&Gurjar, 2013). One critical aspect is the ability to aggregate data in order to derive meaningful and useful characteristics. The root mean square (RMS), skewness, and kurtosis are the three primary statistical characteristics. When damage happens, attention must be paid to pick up these values. The azimuth time domain metric is calculated based on the following equation, where the time signal $x(t)$ has N data points.

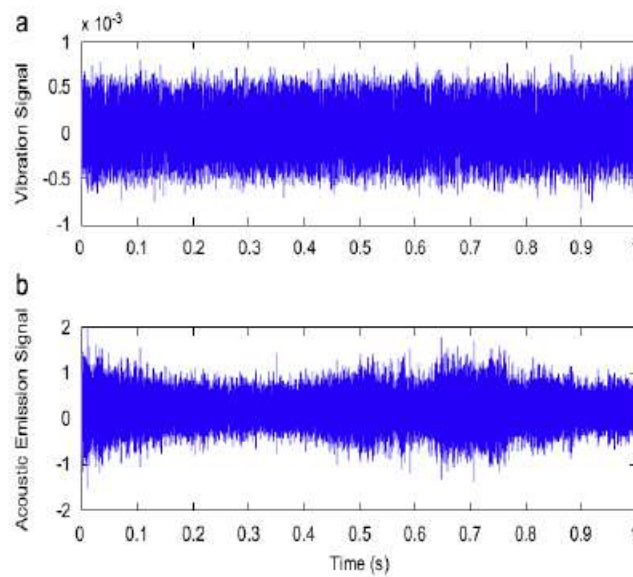

Figure 14. Comparison of the vibration(a) and AE signal(b)
(Purarjomandlangrudi&Nourbakhsh, 2013)

The RMS value describes the capacity of the signal. Usually, the fault is directly identified by the change of the signal RMS fluctuation level. Alternatively, The RMS

value for a particular frequency band reflects a basic value that is almost identical when the system is operating normally. Any modification to this attribute should be considered a malfunction. The Equation 15 is used to measure the RMS value:

$$RMS = \sqrt{\frac{1}{N-1} \sum_{i=1}^N (x_i)^2} \quad (15)$$

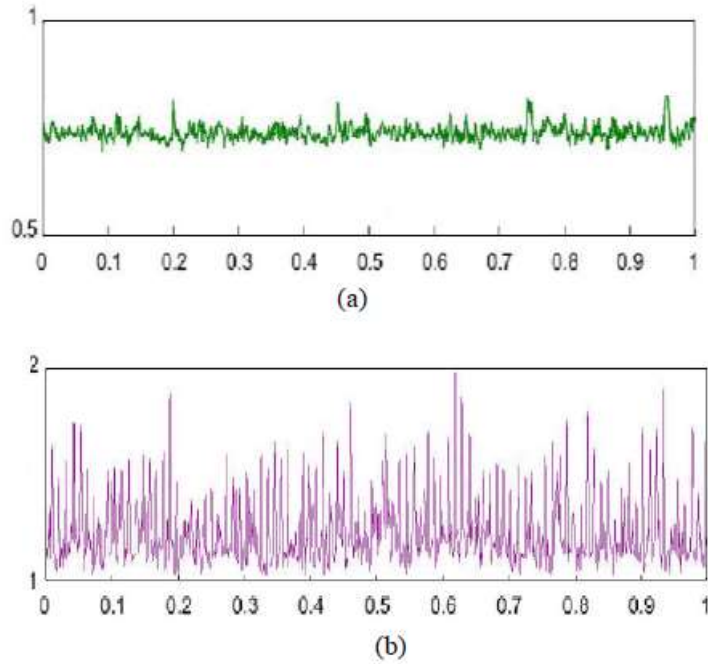

Figure 15. Comparison of the RMS trend of undamaged (a) and damaged (b) signals
Purarjomandlangrudi&Nourbakhsh, 2013)

The third-order statistical moment of the signal is the skewness, which is normalized to the third power by the standard deviation and determined by the Equation 16:

$$S = \frac{1}{N\sigma^3} \sum_{i=1}^N (x_i - \mu)^3 \quad (16)$$

σ is the standard deviation, if the signal and x_i are the signal amplitude, μ is the average. The skew of a single point of the signal indicates the asymmetry of the probability density function, that is, the degree of deviation from the symmetry of the

distribution. If it is negative, the curve moves to the left. If it is positive, the curve moves to the right. If it is zero, the curve is completely symmetrical.

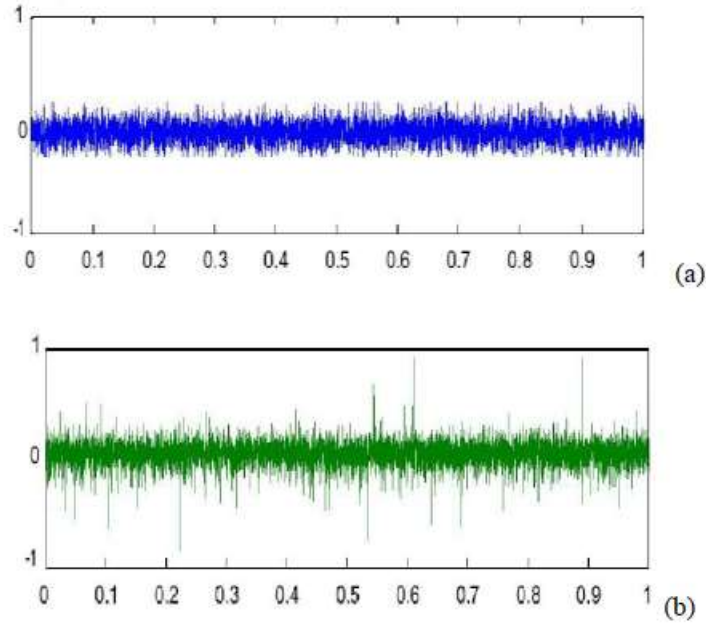

Figure 16. Comparison of the skewness trend of undamaged (a) and damaged (b) signals
Purajomandlangrudi&Nourbakhsh, 2013)

Kurtosis is another characteristic that is characterized as the fourth statistical moment that is normalized to the fourth power by standard deviation. It represents a measure of the density probability function flattening around the average. Kurtosis is a measure of the degree of abnormality in the distribution. The normal distribution has a kurtosis of three; distributions that are more vulnerable to outliers than the normal distribution has a kurtosis greater than three; distributions that are less prone to outliers have a kurtosis less than three. The Equation 17 is used to measure the kurtosis value.

$$K = \frac{1}{N\sigma^4} \sum_{i=1}^N (x_i - \mu)^4 \quad (17)$$

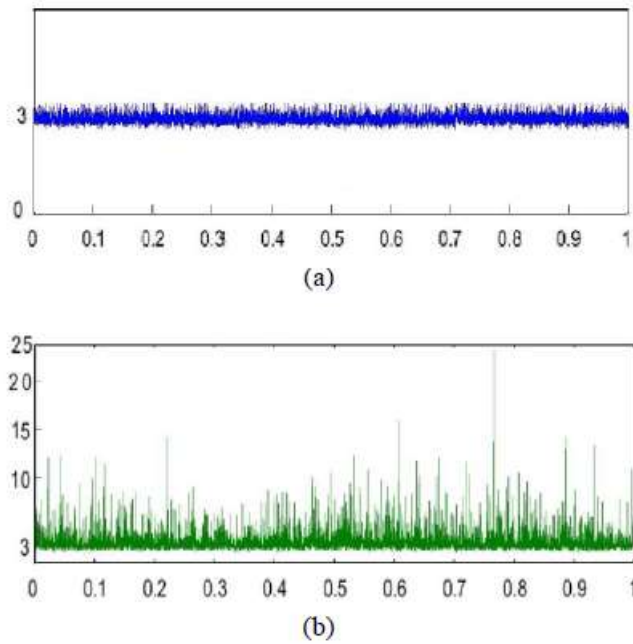

Figure 17. Comparison of the kurtosis trend of undamaged (a) and damaged (b) signals
Purarjomandlangrudi&Nourbakhsh, 2013)

By comparing the raw data of the vibration signal (Figure 14(a)) and the AE signal (Figure 14(b)), it can be concluded that in this experiment, the AE technology is more sensitive to detect the early defects of the bearing than the bearing vibration technology (Lin et al., 2013). However, the large data size associated with high frequency sampling (200kHz in this application) is the primary disadvantage of AE technology for such applications. The Figure 15, Figure 16 and Figure 17 respectively show the difference between the undamaged and impaired waveforms of the parameters of RMS, skewness and kurtosis, as well as the increase or change when the initial defect occurs. These values are determined using the moving window or sub band of the original signal, and the frame duration is 100 *ms*, offset by 50 *ms*.

Through the test, the AE technology can be successfully applied to the condition monitoring of low-speed rotating parts. This technology can detect the small energy release rate generated by initial defects at an incredibly early point. Numerous signal

processing techniques are available for diagnosing faults and fatigue in the AE spectrum. Additionally, the shift in the waveform is critical for identifying the fault.

6 DISCUSSION

AE is clearly a potentially useful NDT process and material detector. It has many key features that allow it to develop rapidly and show its advantages in the field of mechanical monitoring. However, special noise of AE, weakening and other problems and deficiencies distinguish it from most established technologies (Scruby,1987). In the past, failing to realize these sometimes led to AE being abused, which inevitably produced imprecise or erroneous results. Therefore, it is worth to list some of the main characteristics of AE.

(1) The ultrasonic source is internal, emanating from the defect or the process itself, which is different from the technology of external sources such as ultrasound. Therefore, a large body can be continuously tracked through a moderate receiving transducer array, which is a significant benefit. This also means that it is difficult to improve the sound field produced by the sound source in order to increase sensitivity, and that weak events cannot be detectable.

(2) Many important AE events are irreversible. Since the event does not happen repeatedly, it cannot be missed. Therefore, the AE system must be very reliable. Specifically, the sensor must cover all places in the monitoring range. To increase the precision of measurement results, many sensors can also be used to ensure that no signal is missed.

(3) The majority of AE events occur at random times and are intermittent and general in nature. Therefore, many conventional methods of reducing noise cannot be used to increase sensitivity. However, during long-term surveillance, location-based spatial filtering and pattern recognition technologies still have scope. For most NDT applications, low-noise instruments, noise-free environments, and subsequent noise reduction processing are essential.

(4) AE is a technology that operates in real time. It will detect defects as the defects develop and are monitored as they occur. After the event, the regular NDT will conduct a static measurement. The benefit is that AE detects only defects that are actively developing under strain, which means that it prioritizes the most dangerous defects. If the surface is fretting, static defects can be detected under cyclic loading. Unfortunately, AE may also be susceptible to different sources of spurious noise, although these sources of spurious noise can usually be distinguished. Some people think that it is disadvantageous that the content must be replaced. A structure must be able to withstand any kind of changing stress. The best time to use AE is during verification testing or under duty load conditions.

(5) AE amplitude often depends on the rate of change of internal stress, that is, the rate of change of defect size in non-destructive testing applications. Additionally, the overall size of a large defect can enhance the signal by acting as a "castanette", which affects the amplitude and is more difficult to infer than the incremental size. This temporal dependency results in dramatic shifts in sensitivity to various sources. Therefore, AE is sensitive to small increments of crack length ($\approx 1\mu m$) of brittle materials but is not sensitive to larger crack propagation in ductile materials with weaker toughness.

(6) The attenuation of the AE signal is inevitable. The different attenuation mechanisms of AE involve many theories, which are difficult to measure through calculation and simulation. Therefore, it is generally based on experimental data. As the signal frequency increases, internal friction will increase and accelerate the process of attenuation. How to improve the accuracy of the signal as much as possible in the case of the least attenuation is also a need for overall planning before the experiment.

AE is a novel dynamic and non-destructive monitoring technique that uses the stress wave generated by the structure to determine the degree of internal damage. It can be used when the internal composition, defects or potential defects of components

are in the process of moving and changing. Compared to the conventional non-destructive testing technology, it has two basic characteristics. The first is that it is sensitive to dynamic defects, which can be real-time monitored during initiation and expansion of defects (Qiao et al., 2019). The other is that the AE wave comes from the defect itself rather than the somewhere else or outside. The detailed information about the defect can be obtained by the wave to guarantee the result with high detection sensitivity and resolution (Yang&Ma, 2006). Its advantages are mainly as follows:

(1) AE is a method of conducting a dynamic inspection. AE detects energy emitted by the material being tested, rather than energy supplied by non-destructive measurement methods such as ultrasonic or radiographic testing.

(2) The identification of AE is more vulnerable to linear defects. It can detect the behavior of these defects in the presence of external structural stress, while stable defects do not emit acoustic signals.

(3) In a testing process, the AE inspection can monitor and appraise the state of defects in the entire structure.

(4) It can provide real-time or continuous information about defects that change in response to external variables such as load, time, and temperature, making it ideal for tracking industrial processes online and predicting harm in real-time or near-real-time (Shevchik et al., 2018).

(5) Due to the low access criteria for the tested components, it is well suited for testing in conditions that are difficult or impossible to access using other methods, such as extreme heat or cold, radioactive radiation, flammable, destructive, or highly hazardous environments.

(6) For periodic inspection of pressure vessels in service, AE inspection method can shorten the inspection shutdown time or eliminate the need to stop production.

(7) For the pressure test of pressure vessels, the AE inspection method can prevent the catastrophic failure of the system caused by unknown discontinuous defects and limit the maximum working pressure of the system.

(8) Due to the fact that it is not sensitive to the geometric shape of the object, it is well suited for monitoring complicated components that are difficult to monitor using other methods.

Since AE monitoring is a dynamic monitoring method, which detects mechanical waves, it has the following limits.

(1) AE is very sensitive to materials and are susceptible to interference from electromechanical noise. Therefore, the correct interpretation of data requires a richer database and on-site testing experience.

(2) AE detection generally requires an appropriate loading program. In most cases, ready-made loading conditions can be used, but sometimes, special preparations are required.

(3) AE monitoring can only provide location, activity and intensity of AE source, but cannot provide the nature and size of the flaw in AE source. It still needs to rely on other non-destructive testing methods for re-inspection.

AE technology has many inherent advantages. It can easily monitor large structures, can select changes and increasing defects, and report changes when they occur, and can be very sensitive. These shortcomings often occur when using it as an NDT tool rather than for process monitoring. The most significant shortcoming is that it is insensitive to slowly evolving events, cannot enhance the signal, reduce noise, and has attenuation. Given the prior knowledge of this problem and the most likely damage process in each application, one should ensure that AE is only used when there is a high chance of success. To compensate for its insensitivity to slow crack development, it should keep in mind that the most severe defects in a structure are often the fastest-

growing defects. When the defects are smaller, other inspection techniques may ignore these defects. These are easily detectable through AE. Larger ductile cracks in pressure vessel steel may be less susceptible to AE in the absence of corrosion. Therefore, they should only grow slowly during use and are unlikely to fail prematurely. In the routine inspection process, NDT technology should be used to detect it anyway. Therefore, AE is most suitable as an auxiliary tool for inspection technology. In the early years, AE achieved various successes in structural testing and monitoring technology. The scope of the problem has been concentrated to the known high probability of success, that is, the prior knowledge of materials and the environment indicates the growth of detectable defects. For example, it has been well used in the testing of glass fiber composite materials and has shown the damage evolution of materials in the process of tensile failure in stages. It can never be judged by the same standards as radiography, magnetic particle inspection, and ultrasound due to the fundamentally different physical concepts.

With the development of wireless data communication technology, universal wireless AE devices that meet the requirements of practical applications have appeared on the market. In some special fields, more and more wired and cable AE meters have been replaced, showing a development trend similar to wireless mobile phones replacing wired landlines and wireless strain gauges replacing wired strain gauges. Technical indicators of Wi-Fi wireless data communication have reached the wireless data transmission speed of 300Mbps, and the transmission distance exceeds 10 kilometers, which can meet the requirements of most AE applications. With the realization of three data streams and four data streams Wi-Fi, the transmission speed technical indicators are constantly being refreshed to 450 Mbps and 600 Mbps. The new and higher indicators of wireless AE devices will continue to appear. The wireless acoustic transmitter can use GPS timing technology to realize high-precision wireless multi-channel data acquisition with the same clock to realize the function of time difference positioning.

The frequency ranges of AE of different materials differ, ranging from infrasound frequency, audio frequency to ultrasonic frequency. AE occurs when most metal materials are plastically deformed and fractured. However, the signal strength of AE in most metal materials is so poor that it cannot be detected directly by human ears. Therefore, sensitive electronic equipment is required to monitor the signal. The AE technology refers to the detecting, recording and analyzing AE signals through instruments to infer the source of AE. AE technology is an emerging method in the field of non-destructive testing. At present, the basic theoretical research of AE sources is not mature and signal processing does not have the ability to effectively remove noise and frequency division. Most of the current studies were focused on the theory and simulation. There is still a gap with actual engineering applications which are reflected in the following aspects:

- (1) Due to the imperfect basic theories of AE mechanism and propagation, the application and development of AE technology has always relied on the extraction and analysis of characteristic parameters. Therefore, it is impossible to directly obtain the information of the AE source signal to realize the quantitative detection.
- (2) AE technology is still in the stage of exploration and lacks relevant technical standards. For the same state, if the selection of characteristic parameters is different, the obtained data and conclusions may be very inconsistent, which have significant effects on the reliability of the test results.
- (3) AE sources have many different types and modes. AE signals have the characteristics of difference, weakness, and unpredictability. Environmental interference and noise are complex and changeable. These factors make it difficult to obtain useful information from complex signals, which become major issue in the research of AE technology.
- (4) During the monitoring process, the AE signal contains a large amount of data information as there is more than one AE source. The acquisition of its signal characteristic parameters, the analysis of corresponding signal and the processing methods have become another major issue in the research of AE technology. In

addition, the massive of data collected during AE is also a huge challenge to the hardware.

- (5) The attenuation of the wave controls the detectability of the distance of sound source. It is a key factor in determining the sensor spacing in AE testing. In actual monitoring, the wave attenuation mechanism is very complicated and difficult to calculate through theoretical formulas. It is generally obtained through experimental measurement. As the frequency of the sound wave increases, the internal friction also increases, resulting in faster attenuation. Reducing the sensor frequency or reducing the distance between the sensors is the common solution. However, it will greatly increase the complexity of data processing and the expenditure of equipment. Therefore, how to balance the influence of wave attenuation and experimental complexity and capital expenditure are also a problem that needs to be studied.
- (6) At present, the AE monitoring equipment has only single function. The anti-interference ability and noise elimination ability of the related equipment are not enough to adapt to the needs of various engineering applications. Related companies are lack of concepts of advanced equipment design, manufacturing technologies, signal data analysis and relevant processing software. Existing auxiliary equipment and consumables manufacturing technology including the methods used still need to be improved. When the multi-channel sensor is used, large number of corresponding signal lines are needed which is inconvenience to the actual application. The performance of the existing coupling agent cannot meet various requirements.
- (7) The existing signal processing technology cannot process the AE signal immediately. It is difficult to provide timely information on warning, diagnosis and analysis of engineering equipment which hinders the development of online monitoring technology.
- (8) The existing AE monitoring technology has a relatively narrow application which has been mostly used as an after-the-fact detection method. The method of online monitoring and analysis of equipment has not widely used due to the insufficient

knowledge. The advantages of AE technology are not taken, and the theoretical innovation and technological development in AE are limited currently.

The situation is very different in the field of process monitoring. Due to the specific detection range of AE, AE can only be used when the sound emitted by the process of interest can be detected by the transducer at a level higher than the general background noise. This problem can usually be solved fairly quickly by performing appropriate experimental measurements or interference procedures at minimal cost. Of course, this process also requires overall planning of cost factors such as manpower, equipment, and time. Another important question is whether changes in emission characteristics reflect the key changes in the process, involving broader measurements. The response is always yes, but the changes can be more gradual than expected. The goal is process control, which feeds back the signal used in the automatic exposure system to the process controller. Therefore, AE system must decide and feed it back quickly enough to maintain process control. So far, AE is gradually being proved to be a cheap enough non-intrusive measurement technology, and it is gradually being more widely used in the process industry. In fact, the work that needs to be studied in the areas of defect detection and monitoring and structural evaluation: (1) Theoretical research on AE wave propagation and waveform conversion methods, which provides a theoretical basis for the application of AE technology in engineering; (2) Development and application used in various engineering detection AE signal data analysis and processing software and instruments; (3) Develop AE sensors suitable for non-rhino environment and different structural performance to promote the application of AE technology; (4) Combination with pattern recognition and prediction technology, which make full use of the AE source information contained in the AE signal to realize AE source pattern recognition and structural failure prediction.;(5) Strengthening the development and research of AE, especially the development and production of all-digital AE instruments; (6) Developing new methods and standards for AE detection/monitoring and evaluation.

7 CONCLUSIONS

This thesis gives a detailed introduction to the signal monitoring and analysis of AE. The principle of AE and the attenuation in the AE process are explained to help better understand this process. In the process of AE monitoring, monitoring technology, related equipment, noise problems and solutions are introduced in detail. In the process of AE analysis, parameter analysis, frequency spectrum analysis, wavelet analysis and neural network analysis are several common methods. Their mathematical principles or logic principles are all enumerated in the form of words, formulas, and diagrams. Afterwards, an example of using AE for fault detection of rotating machinery was shown. In the discussion, some noteworthy characteristics of AE technology and the advantages and disadvantages of AE technology are listed.

AE technology is mainly used in the monitoring and identification of machine faults in the field of condition monitoring and has achieved great success. It will be applied to the construction of intelligent condition monitoring systems in the future, becoming a new trend in the field of condition monitoring. In addition, the application of AE technology in the field of condition monitoring is facing certain difficulties. The majority of them are still in theoretical research and experimental analysis, and the technical theories and standards are not yet perfect and still need to be developed. Therefore, it is necessary to use an integrated computer platform to construct a professional detection system, develop the AE detection technology in an all-round way, and open a broader research field, including:

(1) Research on the characteristics of AE sources. The study of AE source characteristics can provide important theoretical support for the development of AE technology and enhances the scientific nature of AE detection technology.

(2) Research on multi-sensor information collection. Multi-sensor information fusion technology combines the information measured by multiple sensors to realize multi-

parameter and multi-signal intelligent decision-making, which is expected to make a more comprehensive and accurate evaluation of AE sources.

(3) Research on new signal processing technology. The waveform analysis method of all the information of the AE source has gradually developed into the mainstream method, which provides ideas and methods for solving the problems of feature parameter extraction, interference noise processing, and prediction model construction.

BIBLIOGRAPHY

Aggelis, D. G., & Matikas, T. E. (2012). Effect of plate wave dispersion on the acoustic emission parameters in metals. *Computers & structures*, 98, 17-22.

Asamene, K., Hudson, L., & Sundaresan, M. (2015). Influence of attenuation on acoustic emission signals in carbon fiber reinforced polymer panels. *Ultrasonics*, 59, 86-93.

BENZ, A. G. (1998). Use of acoustic emission techniques for detection of discontinuities. *Materials evaluation*, 56(10), 1215-1222.

Bhuiyan, M. Y., Bao, J., Poddar, B., & Giurgiutiu, V. (2018). Toward identifying crack-length-related resonances in acoustic emission waveforms for structural health monitoring applications. *Structural Health Monitoring*, 17(3), 577-585.

Brankamp, K. (1996). Monitoring forces and acoustic emission in cold forming. *Wire*, 46, 334-335.

Chen Yu-hua, Liu Shi-feng, Geng Rong-sheng, & Shen Gong-tian. (2002). Spectral analysis and correlation analysis of acoustic emission signals. *Non-destructive testing*, 24(9), 395-399.

Dhole, N. P., & Gurjar, D. A. A. (2013). Detection of Speech Under Stress Using Spectral Analysis. *International Journal of Research in Engineering and Technology (IJRET)*, 2.

Dornfeld A, D. (1994). In process recognition of cutting states. *JSME international journal. Ser. C, Dynamics, control, robotics, design and manufacturing*, 37(4), 638-650.

Dornfeld, D. A. (1984). Acoustic emission in monitoring and analysis in manufacturing. *Proc. of AE Monitoring and Analysis in Manufacturing*, 14, 124.

Drouillard, T. F. (1994). Acoustic emission: The first half century (No. RFP-4875; CONF-9410182-1). EG and G Rocky Flats, Inc., Golden, CO (United States). *Rocky Flats Plant*, 1-17.

Elforjani, M., & Shanbr, S. (2017). Prognosis of bearing acoustic emission signals using supervised machine learning. *IEEE Transactions on industrial electronics*, 65(7), 5864-5871.

FOWIER, T. (1986). Experience with acoustic emission monitoring of chemical process industry vessels. *Progress in Acoustic Emission III*, 150-162.

Fowler, T. J. (1979). Acoustic emission of fiber reinforced plastics. *Journal of the Technical Councils of ASCE*, 105(2), 281-289.

Gallego, A., Gil, J. F., Vico, J. M., Ruzzante, J. E., & Piotrkowski, R. (2005). Coating adherence in galvanized steel assessed by acoustic emission wavelet analysis. *Scripta Materialia*, 52(10), 1069-1074.

Geng Rong-sheng, Shen Gong-tian, & Liu Shi-feng. (2002). An overview on the development of acoustic emission signal processing and analysis technique. *NDT*, 24(1), 23-28.

Geng Rong-sheng. (2001). Non-destructive testing technology in the new millennium: Looking at the development direction of non-destructive testing technology from the Rome Conference. *Non-destructive testing*, 23(1), 2-5.

Gong Li-hai, & Yang Neng-jun. (2009). Several Problems on Engineering Application of Acoustic Emission Technique and the Solutions. *Science and Technology of West China*, 8(10), 37-39.

Gorman, M. R. (1991). Plate wave acoustic emission. *The Journal of the Acoustical Society of America*, 90(1), 358-364.

Guo, Y. B., & Ammula, S. C. (2005). Real-time acoustic emission monitoring for surface damage in hard machining. *International Journal of Machine Tools and Manufacture*, 45(14), 1622-1627.

Hu Changyang, Yang Gangfeng, Huang Zhenfeng, & Mao Hanling. (2008). Acoustic emission technology and its application in detection. *Doctoral dissertation*,1-6.

Hu Guang-shu. (2005). Digital signal processing-theory, algorithm and implementation. *2nd ed. Beijing: TsingHua University Press.*

Huang, M., Jiang, L., Liaw, P. K., Brooks, C. R., Seeley, R., & Klarstrom, D. L. (1998). Using acoustic emission in fatigue and fracture materials research. *Jom*, 50(11), 1-14.

Inasaki, I. (1998). Application of acoustic emission sensor for monitoring machining processes. *Ultrasonics*, 36(1-5), 273-281.

Kaiser, J. (1950). Untersuchungen uber das Auftreten Gerauschen beim Zugversuch.(A Study of Acoustic Phenomena in Tensile Tests) (Doctoral dissertation, Ph. D. Thesis. Technische Hochschule of Munchen. Munich Germany, 1950. Translated UCRL-Trans-1082 (L)).

Khamedi, R., Fallahi, A., & Oskouei, A. R. (2010). Effect of martensite phase volume fraction on acoustic emission signals using wavelet packet analysis during tensile loading of dual phase steels. *Materials & Design*, 31(6), 2752-2759.

Kwak, J. S., & Ha, M. K. (2004). Neural network approach for diagnosis of grinding operation by acoustic emission and power signals. *Journal of Materials Processing Technology*, 147(1), 65-71.

Li Guanghai. (2001). Progress in Acoustic Emission Inspection Technology. *Journal of Nanchang Institute of Aeronautical Technology*,15(2),39-43

Li Meng-yuan. (2010). Acoustic emission detection and signal processing. Science Press.

Li, X., & Wu, J. (2000). Wavelet analysis of acoustic emission signals in boring. *Proceedings of the Institution of Mechanical Engineers, Part B: Journal of Engineering Manufacture*, 214(5), 421-424.

Lin, T. R., Kim, E., & Tan, A. C. (2013). A practical signal processing approach for condition monitoring of low speed machinery using Peak-Hold-Down-Sample algorithm. *Mechanical systems and signal processing*, 36(2), 256-270.

Liu Song-Qiang. (1996). Digital signal processing system and its application. *Tsinghua University Press*.

Liu Zhen-qing, & Chen Guang. (2001). Spectral analysis technology in ultrasonic non-destructive testing. *Non-destructive testing*, 2, 85-88.

Liu, J. J., & Dornfeld, D. A. (1996). Modeling and analysis of acoustic emission in diamond turning. *Journal of Manufacturing Science and Engineering*, 118, 199-207.

Lou, K. N., & Lee, C. T. (1995, October). An intelligent on-line tool monitoring system in milling processes. In *1995 IEEE International Conference on Systems, Man and Cybernetics. Intelligent Systems for the 21st Century* (Vol. 3, pp. 2651-2656). IEEE.

Maddox, S. J. (1991). Fatigue strength of welded structures. *Woodhead publishing*, 115-128.

Meng, X., Liu, W., & Ding, E. (2011, October). The research of acoustic emission signal classification. In *2011 Seventh International Conference on Intelligent Information Hiding and Multimedia Signal Processing* (pp. 41-44). IEEE.

Meylan, B., Shevchik, S. A., Parvaz, D., Mosaddeghi, A., Simov, V., & Wasmer, K. (2021). Acoustic emission and machine learning for in situ monitoring of a gold-copper ore weakening by electric pulse. *Journal of Cleaner Production*, 280, 124348.

Morizet, N., Godin, N., Tang, J., Maillet, E., Fregonese, M., & Normand, B. (2016). Classification of acoustic emission signals using wavelets and Random Forests: Application to localized corrosion. *Mechanical Systems and Signal Processing*, 70, 1026-1037.

Muravin, B. (2009). Acoustic emission science and technology. *Journal of Building and Infrastructure Engineering of the Israeli association of engineers and architects*, 1, 4-5.

Nazarchuk, Z., Skalskyi, V., & Serhiyenko, O. (2017). Acoustic emission. *Foundations of Engineering Mechanics*, 75-98.

Ni, Q. Q., & Iwamoto, M. (2002). Wavelet transform of acoustic emission signals in failure of model composites. *Engineering Fracture Mechanics*, 69(6), 717-728.

Ohtsu, M. Recommendation of RILEM TC 212-ACD: acoustic. *Materials and Structures*, 43(9), 1183-1186.

Planes, A., Mañosa, L., & Vives, E. (2013). Acoustic emission in martensitic transformations. *Journal of Alloys and Compounds*, 577, S699-S704.

Pollock, A. A. (1986). Acoustic emission capabilities and applications in monitoring corrosion. In *Corrosion Monitoring in Industrial Plants Using Nondestructive Testing and Electrochemical Methods*. ASTM International, 30-42.

Pruitt, B. L., & Dornfeld, D. A. (1996, July). Monitoring end mill contact using acoustic emission. In *Proceedings of the Japan/USA Symposium on Flexible Automation* (Vol. 1, pp. 421-426).

Purarjomandlangrudi, A., & Nourbakhsh, G. (2013). Acoustic emission condition monitoring: an application for wind turbine fault detection. *International Journal of Research in Engineering Technology*, 2(5), 907-918.

Qi, G. (2000). Wavelet-based AE characterization of composite materials. *NDT & e International*, 33(3), 133-144.

Qiao, X., Weng, W. X., & Li, Q. (2019). Acoustic emission monitoring and failure behavior discrimination of 8YSZ thermal barrier coatings under Vickers indentation testing. *Surface and Coatings Technology*, 358, 913-922.

Ravishankar, S. R., & Murthy, C. R. L. (2000). Characteristics of AE signals obtained during drilling composite laminates. *NDT & E International*, 33(5), 341-348.

Runow, P. (1985). The use of acoustic emission methods as aids to the structural integrity assessment of nuclear power plants. *International journal of pressure vessels and piping*, 21(3), 157-207.

Sachse, W., & Grabec, I. (1994). Intelligent processing of acoustic emission signals: Materials Evaluation, Vol. 50, No. 7, pp. 826–834 (Jul. 1992). *NDT & E International*, 27(4), 212.

Saeedifar, M., & Zarouchas, D. (2020). Damage characterization of laminated composites using acoustic emission: A review. *Composites Part B: Engineering*, 108039.

Sato, K. (1996). Development of plywood grader using acoustic emission. *Progress in Acoustic Emission VIII*, 267-272.

Schofield, B. H. (1961). Acoustic Emission under applied stress, ARL-150. Wright Patterson Air Force Base, Ohio.

Scruby, C. B. (1987). An introduction to acoustic emission. *Journal of Physics E: Scientific Instruments*, 20(8), 946.

Shen Gongtian, Dai Guang, & Liu Shifeng. (2003). Progress in Acoustic Emission Detection Technology in China-The 25th Anniversary of the Founding of the Society (Doctoral dissertation). *NDT*. 25(6), 302-307.

Shen Gong-tian, Duan Qing-ru, Zhou Yu-feng, Li Bang-xian, Liu Qi-zhi, Li Chun-shu, & Jiang Shi-liang. (2001). Research on Artificial Neural Network Pattern Recognition Method for Acoustic Emission Signal of Pressure Vessel. *Nondestructive Testing*, 23(4), 144-146+.

Shen Gong-tian, Geng Rong-sheng, & Liu Shi-feng. (2002). Parameter analysis method of acoustic emission signal (Doctoral dissertation). *NDT*, 24(2), 72-77

Shevchik, S. A., Kenel, C., Leinenbach, C., & Wasmer, K. (2018). Acoustic emission for in situ quality monitoring in additive manufacturing using spectral convolutional neural networks. *Additive Manufacturing*, 21, 598-604.

Song, S. P., & Que, P. W. (2006). Wavelet based noise suppression technique and its application to ultrasonic flaw detection. *Ultrasonics*, 44(2), 188-193.

Stockbridge, S., & Hoffman, J. (1994). Analysis of acoustic emission data from metal pressure vessel by weighing of data at 2tributes, Including MONPAC criteria. *Progress in Acoustic Emission*.

Tönshoff, H. K., Jung, M., Männel, S., & Rietz, W. (2000). Using acoustic emission signals for monitoring of production processes. *Ultrasonics*, 37(10), 681-686.

Wang Xiang-hong, Xiang Jian-jun, Hu Hongwei, Xie Wei, & Mao Han-ling. (2015). Detection of material component fractions based on attenuation characteristics of acoustic emission signals (Doctoral dissertation). *Chinese Journal of Scientific Instrument*.39(2)453-457.

Watson, N. J., Povey, M. J. W., Reynolds, G. K., Xu, B. H., & Ding, Y. (2014). Acoustic emission monitoring from a lab scale high shear granulator—A novel approach. *International journal of pharmaceutics*, 465(1-2), 262-274.

Webster, J., Marinescu, I., Bennett, R., & Lindsay, R. (1994). Acoustic emission for process control and monitoring of surface integrity during grinding. *CIRP annals*, 43(1), 299-304.

Xie Chaoyang (2009). Analysis of acoustic emission signal processing methods. *China Science and Technology Information*, 5, 131-132.

Xu Pei-xia & Sun Gong-xian. (2001). Wavelet analysis and application examples. *University of Science and Technology of China Press*.

Xu Zhong-lin, Li Guo-lu, Dong Tian-shun, Liu Jin-hai, Wang Hai-dou, & Kang Jia-jie. (2014). Research progress in acoustic emission signal analysis and processing methods. *Materials Review*, 28(5), 56-60.

Yan Su-zhen, & Liu Man-cang. (2002). Acoustic emission technology and its application. *Journal of Xi'an Aerotechnical College*, 20(1), 64-64.

Yang Mingwei, & Geng Rongsheng. (2005). Acoustic emission detection. *Beijing:China Machine Industry Publishing House*,1.

Yang, R. F., & Ma, T. H. (2006). A study on the applications of acoustic emission technique. *Journal of North University of China (Natural Science Edition)*, 27(5), 456-461.

Yi Ruoxiang, Liu Shifeng, Geng Rongsheng, & Shen Gongtian. (2002). Application of artificial neural network in acoustic emission detection (Doctoral dissertation). *Non-destructive testing*,24(11),488-496.

Yuan Chen. (2011). Analysis of acoustic emission signal. *Electronic Design Engineering*, 19(21).125-127

Zhang Ping, Shi Keren, & Liu Shifeng. (2000). Acoustic emission signal pattern recognition method based on radial basis function neural network. *In Proceedings of the First International Conference on Mechanical Engineering*, -127-Electronic Design Engineering, No. 21, 2011 Beijing: China Machinery Industry Press.

Zhang Pi-zhuang & Liu shu-mao (2004). Study on acquisition and control technology for ultrasonic detecting system[J]. *Journal of North China Institute of Technology*,25(3): 231—234.

Zhao, L., Kang, L., & Yao, S. (2018). Research and application of acoustic emission signal processing technology. *IEEE Access*, 7, 984-993.